

**UNITED STATES  
SECURITIES AND EXCHANGE COMMISSION**  
Washington, D.C. 20549

**FORM 8-K**

**CURRENT REPORT**  
Pursuant to Section 13 or 15(d)  
of the Securities Exchange Act of 1934

**December 8, 2022**  
Date of Report (date of earliest event reported)

**GIGCAPITAL5, INC.**  
(Exact name of Registrant as specified in its charter)

**Delaware**  
(State or other jurisdiction of  
incorporation or organization)

**001-40839**  
(Commission  
File Number)

**86-1728920**  
(I.R.S. Employer  
Identification Number)

**1731 Embarcadero Rd., Suite 200**  
**Palo Alto, CA 94303**  
(Address of principal executive offices)  
**(650) 276-7040**  
(Registrant's telephone number, including area code)

Check the appropriate box below if the Form 8-K filing is intended to simultaneously satisfy the filing obligation of the registrant under any of the following provisions (see General Instruction A.2. below):

- Written communications pursuant to Rule 425 under the Securities Act (17 CFR 230.425)
- Soliciting material pursuant to Rule 14a-12 under the Exchange Act (17 CFR 240.14a-12)
- Pre-commencement communications pursuant to Rule 14d-2(b) under the Exchange Act (17 CFR 240.14d-2(b))
- Pre-commencement communications pursuant to Rule 13e-4(c) under the Exchange Act (17 CFR 240.13e-4(c))

Securities registered pursuant to Section 12(b) of the Act:

Title of each class	Trading Symbols	Name of each exchange on which registered
Units, each consisting of one share of common stock, \$0.0001 par value, and one redeemable warrant	GIA.U	The New York Stock Exchange
Common Stock, par value \$0.0001 per share	GIA	The New York Stock Exchange
Redeemable warrants, each full warrant exercisable for one share of common stock for an exercise price of \$11.50 per share	GIA.WS	The New York Stock Exchange

Indicate by check mark whether the registrant is an emerging growth company as defined in Rule 405 of the Securities Act of 1933 (§230.405 of this chapter) or Rule 12b-2 of the Securities Exchange Act of 1934 (§240.12b-2 of this chapter).

Emerging growth company

If an emerging growth company, indicate by check mark if the registrant has elected not to use the extended transition period for complying with any new or revised financial accounting standards provided pursuant to Section 13(a) of the Exchange Act.

## Item 1.01 Entry into a Material Definitive Agreement.

On December 12, 2022, GigCapital5, Inc., a Delaware corporation (“GigCapital5”), announced that it executed a Business Combination Agreement (the “Business Combination Agreement”), dated as of December 8, 2022, with QTI Merger Sub, Inc., a Delaware corporation and wholly owned subsidiary of GigCapital5 (“Merger Sub”), and QT Imaging, Inc., a Delaware corporation (“QT Imaging”) (the transactions contemplated by the Business Combination Agreement, the “Business Combination”). This Current Report on Form 8-K (this “Current Report”) provides a summary of the Business Combination Agreement and the other agreements entered into (and certain agreements to be entered into) in connection with the Business Combination. The descriptions of these agreements do not purport to be complete and are qualified in their entirety by the terms and conditions of such agreements or the forms of these agreements, as applicable, copies of which are filed as Exhibits 2.1, 10.1, and 10.2 to this Current Report and are incorporated by reference into this Current Report.

### Business Combination Agreement

The below description of the Business Combination Agreement and the transactions contemplated thereby is not complete and is subject to, and qualified in its entirety by reference to, the actual agreement, a copy of which is filed with this Current Report as Exhibit 2.1, and the terms of which are incorporated in this Current Report by reference. Capitalized terms used but not otherwise defined in this Current Report will have the meanings given to them in the Business Combination Agreement. The Business Combination Agreement has been attached to provide investors with information regarding its terms. It is not intended to provide any other factual information about GigCapital5, QT Imaging, or Merger Sub. In particular, the assertions embodied in the representations and warranties in the Business Combination Agreement were made as of a specified date, may be subject to a contractual standard of materiality different from what might be viewed as material to investors, or may have been used for the purpose of allocating risk between the parties. Accordingly, the representations and warranties in the Business Combination Agreement are not necessarily characterizations of the actual state of facts about GigCapital5, Merger Sub, or QT Imaging at the time they were made or otherwise and should only be read in conjunction with the other information that GigCapital5 makes publicly available in reports, statements and other documents filed with the Securities and Exchange Commission (“SEC”).

### The Merger

Pursuant to the terms of the Business Combination Agreement, Merger Sub will merge with and into QT Imaging (the “Merger”), with QT Imaging as the surviving company in the Merger (the “Surviving Corporation”), and after giving effect to the Merger, the Surviving Corporation will be a wholly owned subsidiary of GigCapital5, which will be renamed as QT Imaging Holdings, Inc. (“QTI Holdings”).

At the effective time of the Merger (the “Effective Time”), each issued and outstanding share of the common stock of QT Imaging (the “Company Common Stock”) (including shares issued upon the exercise or conversion of Company Options, Company Warrants and Company Convertible Notes, but excluding each share of Company Common Stock held in the treasury of QT Imaging which will be cancelled without any conversion of such shares of Company Common Stock held in the treasury) will be automatically cancelled and extinguished and converted into (A) the right to receive a number of shares (the “Per Share Merger Consideration”) of common stock of GigCapital5 (the “GigCapital5 Common Stock”) equal to the Exchange Ratio (as defined below) and (B) the contingent right to receive a portion of the Merger Consideration Earnout Shares (as defined below), if, as and when payable.

The “Exchange Ratio” means the quotient of (a) the Aggregate Closing Merger Consideration (as defined below) divided by (b) the Company Fully Diluted Capital Stock (as defined below). The “Aggregate Closing Merger Consideration” means a number of shares of GigCapital5 Common Stock equal to the difference of: (a) the quotient of (i) the Aggregate Closing Merger Consideration Value (as defined below), divided by (ii) \$10.00; minus (b) the Aggregate Excess Company Transaction Expenses Shares (as defined below). The “Aggregate Closing Merger Consideration Value” means (a) the sum of (i) \$151,000,000, plus (ii) the sum of the exercise prices of all In-the-Money Company Warrants, plus (iii) the cash of QT Imaging as of immediately prior to the Effective Time (the “Company Closing Cash”), plus (iv) the Paid Company Transaction Expenses (as defined below), minus (b) the debt of QT Imaging as of immediately prior to the Effective Time after conversion of any Company Convertible Notes that are being converted into shares of Company Common Stock immediately prior to the Effective Time in accordance with the terms of such Company Convertible Notes (the “Converting Notes”), and which debt of QT

Imaging will not exceed \$4,000,000. The “Aggregate Excess Company Transaction Expenses Shares” means a number of shares of GigCapital5 Common Stock equal to the quotient of (a) the amount of transaction expenses of QT Imaging incurred by or on its behalf in connection with the preparation, negotiation and execution of the Business Combination Agreement and the consummation of the transactions that the Business Combination Agreement contemplates (the “Company Transaction Expenses”), in excess of \$4,000,000, if any, divided by (b) \$10.00, and rounded up to the nearest whole share, and will include all shares to be issued to two entities providing services to QT Imaging as partial payment of the Company Transaction Expenses for such entities. The “Paid Company Transaction Expenses” are all Company Transaction Expenses that QT Imaging will have paid prior to the close of business on the business day immediately preceding the Closing (as defined below).

The “Company Fully Diluted Capital Stock” means, without duplication, the sum of (a) the aggregate number of shares of Company Common Stock that are issued and outstanding as of immediately prior to the Effective Time (including shares issued upon the exercise of Company Options, the shares issued upon exercise of Company Warrants, and the shares issued pursuant to the conversion of the Company Convertible Notes (the “Company Convertible Notes Shares”), in each case immediately prior to the Effective Time, excluding each share of Company Common Stock held in the treasury of QT Imaging which will be cancelled without any conversion of such shares of Company Common Stock held in the treasury), and (b) the aggregate number of shares of Company Common Stock issuable upon full exercise, exchange or conversion of all In-the-Money Company Warrants (the “In-the-Money Company Warrant Shares,” which together with the Company Common Stock, the In-the-Money Company Warrants and the Company Convertible Notes Shares will constitute the “Company Equity Securities”) outstanding as of immediately prior to the Effective Time and that will become an Assumed Warrant (as defined below).

Effective as of the Effective Time, each outstanding In-the-Money Company Warrant that is not exercised and exchanged prior to the Effective Time will automatically, without any action on the part of the holder of an In-the-Money Company Warrant, in accordance with the provisions of an In-the-Money Company Warrant (for the avoidance of doubt, as may be amended following the date of this Agreement with the written approval of GigCapital5), be converted into a warrant to acquire a number of shares of GigCapital5 Common Stock at an adjusted exercise price per share (each such resulting warrant, an “Assumed Warrant”). Each Assumed Warrant will be subject to the same terms and conditions as were applicable to such corresponding In-the-Money Company Warrant immediately prior to the Effective Time (including applicable vesting conditions), except to the extent such terms or conditions are rendered inoperative by the Transactions. Accordingly, effective as of the Effective Time: (A) each such Assumed Warrant will be exercisable solely for shares of GigCapital5 Common Stock; (B) the number of shares of GigCapital5 Common Stock subject to each Assumed Warrant will be determined by multiplying the number of shares of Company Common Stock subject to such In-the-Money Company Warrant, as in effect immediately prior to the Effective Time, by the Per Share Merger Consideration, and rounding the resulting number down to the nearest whole number of shares of GigCapital5 Common Stock; (C) the per share exercise price for the GigCapital5 Common Stock issuable upon exercise of each Assumed Warrant will be determined by dividing the per share exercise price for the shares of Company Common Stock subject to the In-the-Money Company Warrant, as in effect immediately prior to the Effective Time, by the Per Share Merger Consideration, and rounding the resulting exercise price up to the nearest whole cent; and (D) the holder of each In-the-Money Company Warrant outstanding as of immediately prior to the Effective Time will be entitled to the contingent right to receive a portion of the Merger Consideration Earnout Shares, if, as and when payable. Effective as of the Effective Time, each Company Warrant (other than any In-the-Money Company Warrant) that is outstanding immediately prior to the Effective Time, whether vested or unvested, will, in accordance with the provisions of such Company Warrant (for the avoidance of doubt, as may be amended following the date of this Current Report with the written approval of GigCapital5), be canceled without any conversion of such Company Warrant and no payment or distribution will be made, and the holder of such Company Warrant will cease to have any rights, with respect to such Company Warrant.

Further, prior to the Effective Time, QT Imaging will in a manner acceptable to GigCapital5 take such actions as are necessary to terminate each Company Option that is outstanding immediately prior to the Effective Time, whether vested or unvested, including by payment or in accordance with the terms of the Company Option Plan, the Company Options will be terminated without any conversion of such Company Options and no payment or distribution will be made, and the holder of any Company Options will cease to have any rights, with respect to such Company Options.

Effective at the Closing, the board of directors of QT Imaging Holdings (the “QTI Holdings Board”) will consist of seven directors in a classified board of directors with three classes, the initial members of which (the “Initial”

Post-Closing QTI Holdings Directors”) will consist of three individuals identified by GigCapital5 who will serve either in Class I or Class III, and which will include the chairman of the QTI Holdings Board, and four individuals identified by QT Imaging who will serve in either Class I, Class II or Class III, and which will include the Chief Executive Officer of QT Imaging.

#### *The Closing*

The closing of the Business Combination (the “Closing”) will occur as promptly as practicable, but in no event later than three Business Days, after the satisfaction or, if permissible, waiver of the conditions set forth in the Business Combination Agreement.

#### *The Earnout Shares*

After the Closing, the holders of the Company Equity Securities as of immediately prior to the Effective Time will have the contingent right to receive additional shares of GigCapital5 Common Stock based on the performance of QTI Holdings of certain requirements (the “Triggering Events”) are achieved. At the Closing and immediately prior to the Effective Time, GigCapital5 will deposit, or will cause to be deposited, with a bank or trust company that will be designated by GigCapital5 and is reasonably satisfactory to QT Imaging (the “Exchange Agent”), among other shares, the sum of 9,000,000 shares of GigCapital5 Common Stock, as such shares may be adjusted for any stock split, reverse stock split, recapitalization, reclassification, reorganization, exchange, subdivision or combination, as a pool of shares that can constitute the “Merger Consideration Earnout Shares.” The Merger Consideration Earnout Shares will be allocated among the Company Equity Securityholders as described below.

Promptly upon the occurrence of any Triggering Event, or as soon as practicable after QTI Holdings becomes aware of the occurrence of such Triggering Event or receives written notice of such Triggering Event, QTI Holdings will prepare and deliver, or cause to be prepared and delivered, a written notice to the Exchange Agent (a “Release Notice”), which Release Notice will set forth in reasonable detail the Triggering Event giving rise to the requested release and the specific release instructions with respect to the requested release (including the number of Merger Consideration Earnout Shares to be released from the fund of shares deposited with the Exchange Agent (the “Exchange Fund”) and the identity of the person to whom they should be released). The Merger Consideration Earnout Shares that are to be released from the Exchange Fund and distributed to the Company Equity Securityholders will be distributed to such Company Equity Securityholders in accordance with their respective Pro Rata Shares (as defined below). The Merger Consideration Earnout Shares will be released and delivered as follows (each of (i), (ii) and (iii) below, a Triggering Event):

(i) promptly following the date on which QTI Holdings files its annual report on Form 10-K with respect to its fiscal year ended December 31, 2023 (the “2023 Form 10-K”) with the SEC, an aggregate of 2,500,000 Merger Consideration Earnout Shares (the “2023 Earnout Shares”) will be released from the Exchange Fund and distributed to the Company Equity Securityholders in accordance with their respective Pro Rata Shares if, and only if, on or prior to such filing date, QT Imaging or QTI Holdings has obtained a formal FDA clearance for breast cancer screening with respect to its breast scanning systems, which remains in full force and effect as of such filing date; provided, that the 2023 Earnout Shares will increase by 500,000 (to an aggregate of 3,000,000) Merger Consideration Earnout Shares if, in addition, during calendar year 2023, QT Imaging, prior to the Closing, and QTI Holdings, following the Closing, either (A) makes at least eight bona fide placements of its breast scanning systems globally or (B) achieves annual revenue of at least \$4,400,000 as set forth in the financial statements included in the 2023 Form 10-K;

(ii) promptly following the date on which QTI Holdings files its annual report on Form 10-K with respect to its fiscal year ended December 31, 2024 (the “2024 Form 10-K”) with the SEC, an aggregate of 2,500,000 Merger Consideration Earnout Shares (the “2024 Earnout Shares”) will be released from the Exchange Fund and distributed to the Company Equity Securityholders in accordance with their respective Pro Rata Shares if, and only if, during calendar year 2024, (A) QTI Holdings achieves annual revenue of at least \$17,100,000 as set forth in the financial statements included in the 2024 Form 10-K, and (B) QTI Holdings makes at least four placements of its breast scanning systems in the United States; provided, that the 2024 Earnout Shares will increase by 500,000 (to an aggregate of 3,000,000) Merger Consideration Earnout Shares if at least one of the following milestones is achieved: (x) on or prior to such filing date, QTI Holdings has obtained a formal FDA clearance for a new indication for use of its breast scanning

systems (other than any indication obtained prior to calendar year 2024), which remains in full force and effect as of such filing date; or (y) QTI Holdings achieves clinical-quality patient images with QTI Holdings' open angle scanner during the 2024 calendar year, as reported in the 2024 Form 10-K;

(iii) promptly following the date on which QTI Holdings files its annual report on Form 10-K with respect to its fiscal year ended December 31, 2025 (the "2025 Form 10-K"), an aggregate of 2,500,000 Merger Consideration Earnout Shares (the "2025 Earnout Shares") will be released from the Exchange Fund and distributed to the Company Equity Securityholders in accordance with their respective Pro Rata Shares if, and only if, during calendar year 2025, (A) QTI Holdings achieves annual revenue of at least \$67,000,000 as set forth in the financial statements included in the 2025 Form 10-K, or (B) the VWAP of shares of GigCapital5 Common Stock equals or exceeds \$15 per share for twenty of any thirty consecutive trading days on the Exchanges (as defined below); provided, that the 2025 Earnout Shares will increase by 500,000 (to an aggregate of 3,000,000) Merger Consideration Earnout Shares if at least one of the following milestones is achieved on or prior to such filing date: (x) QTI Holdings has obtained a formal FDA clearance of its open angle scanner, which remains in full force and effect as of such filing date; or (y) QTI Holdings receives net positive results in bona fide clinical trials, conducted in accordance with generally accepted industry standards, for its open angle scanner, as reported in the 2025 Form 10-K; and

(iv) if the conditions set forth in (i), (ii) or (iii) above for any Merger Consideration Earnout Shares to be released from the Exchange Fund and distributed to the Company Equity Securityholders have not been, and become incapable of being, satisfied, then promptly thereafter such Merger Consideration Earnout Shares will be automatically released to QTI Holdings for cancellation and the Company Equity Securityholders will not have any right to receive such Merger Consideration Earnout Shares or any benefit therefrom.

The term "Pro Rata Share" means, with respect to each Company Equity Securityholder, a ratio calculated by dividing (i) the sum of, without duplication, (A) the total number of shares of Company Common Stock held by such Company Equity Securityholder as of immediately prior to the Effective Time, plus (B) the total number of In-the-Money Company Warrant Shares subject to In-the-Money Company Warrants held by such Company Equity Securityholder as of immediately prior to the Effective Time (to the extent such In-the-Money Company Warrants are not exercised or deemed exercised as of immediately prior to the Effective Time), by (ii) the sum of, without duplication, (A) the total number of shares of Company Common Stock held by all Company Equity Securityholders as of immediately prior to the Effective Time, plus (B) the total number of In-the-Money Warrant Shares (to the extent the applicable In-the-Money Company Warrants are not exercised or deemed exercised as of immediately prior to the Effective Time). Any fractional Merger Consideration Earnout Share that would otherwise be issuable to any person will be rounded up to a whole share of GigCapital5 Common Stock.

The term "VWAP" means, for any security as of any date(s), the dollar volume-weighted average price for such security on the principal securities exchange or securities market on which such security is then traded during the period beginning at 9:30:01 a.m., New York time, and ending at 4:00:00 p.m., New York time, as reported by Bloomberg through its "HP" function (set to weighted average) or, if the foregoing does not apply, the dollar volume-weighted average price of such security in the over-the-counter market on the electronic bulletin board for such security during the period beginning at 9:30:01 a.m., New York time, and ending at 4:00:00 p.m., New York time, as reported by Bloomberg, or, if no dollar volume-weighted average price is reported for such security by Bloomberg for such hours, the average of the highest closing bid price and the lowest closing ask price of any of the market makers for such security as reported by OTC Markets Group Inc. If the VWAP cannot be calculated for such security on such date(s) on any of the foregoing bases, the VWAP of such security on such date(s) will be the fair market value per share on such date(s) as reasonably determined in good faith by a majority of the disinterested independent directors of the QTI Holdings Board at such time.

#### *Stock Exchange Listing*

Pursuant to the terms of the Business Combination Agreement, GigCapital5 is required to use its reasonable best efforts to cause the Per Share Merger Consideration issued in connection with the Business Combination to be approved for listing on the NYSE, NYSE American, or Nasdaq ("Exchanges"); provided that GigCapital5 will require the prior written consent of QT Imaging to change the listing of the Per Share Merger Consideration from the NYSE or NYSE American to Nasdaq.

### *Proxy Statement and Registration Statement*

As promptly as practicable after the execution of the Business Combination Agreement and receipt of the audited consolidated financial statements of QT Imaging and its subsidiaries for the twelve month period ended December 31, 2021, and (ii) the reviewed financial statements of QT Imaging and its subsidiaries for the nine month period ended September 30, 2022, in accordance with the auditing standards of the PCAOB (which together with the audited consolidation financial statements of QT Imaging and its subsidiaries for the twelve month period ended December 31, 2022, constitute the “PCAOB Financial Statements”), GigCapital5 (with the assistance and cooperation of QT Imaging as reasonably requested by GigCapital5) will prepare and file with the SEC a joint proxy statement/prospectus (as amended or supplemented, the “Proxy Statement”) to be sent to the stockholders of GigCapital5 and from which QT Imaging may derive an information statement that it can send to the stockholders of QT Imaging relating to (A) with respect to QT Imaging’s stockholders, the action to be taken by certain stockholders of QT Imaging pursuant to the approval and adoption of the Business Combination Agreement and the Merger and all other transactions contemplated by the Business Combination Agreement and (B) with respect to GigCapital5’s stockholders, the meeting of GigCapital5’s stockholders (the “GigCapital5 Stockholders’ Meeting”) to be held to consider approval and adoption of (1) the Business Combination Agreement and the Merger, (2) the second amended and restated GigCapital5 Certificate of Incorporation, (3) the Equity Plan (as defined below), (4) the classes of the members of the QTI Holdings Board as of immediately following the Effective Time, (5) the election of the Initial Post-Closing QTI Holdings Directors to serve as the members of the QTI Holdings Board as of immediately following the Effective Time and until their respective successors are duly elected or appointed and qualified, and (6) any other proposals the parties deem necessary to effectuate the Merger (collectively, the “GigCapital5 Proposals”) and (ii) GigCapital5 will prepare and file with the SEC a registration statement on Form S-4 (together with all amendments to such registration statement, the “Registration Statement”) in which the Proxy Statement will be included as a prospectus, in connection with the registration under the Securities Act of 1933, as amended (the “Securities Act”) of the shares of GigCapital5 Common Stock to be issued to the stockholders of QT Imaging pursuant to this Agreement.

GigCapital5 will call and hold the GigCapital5 Stockholders’ Meeting as promptly as practicable after the date on which the Registration Statement becomes effective for the purpose of voting solely upon the GigCapital5 Proposals, and GigCapital5 will use its reasonable best efforts to hold the GigCapital5 Stockholders’ Meeting as soon as practicable after the date on which the Registration Statement becomes effective (but in any event no later than thirty days after the date on which the Proxy Statement is mailed to stockholders of GigCapital5). GigCapital5 will use its reasonable best efforts to obtain the approval of the GigCapital5 Proposals at the GigCapital5 Stockholders’ Meeting, including by soliciting from its stockholders’ proxies as promptly as possible in favor of the GigCapital5 Proposals, and will take all other action necessary or advisable to secure the required vote or consent of its stockholders. The board of directors of GigCapital5 will recommend to the stockholders of GigCapital5 that they approve the GigCapital5 Proposals and will include such recommendation in the Proxy Statement.

### *Representations and Warranties*

The Business Combination Agreement contains customary representations and warranties of the parties to the Business Combination Agreement with respect to, among other things, (a) organization and qualification, subsidiaries, (b) company organizational documents, (c) capitalization, (d) authority relative to the agreement, (e) no conflicts, required filings and consents, (f) permits, compliance, (g) regulatory matters, (h) financial statements, (i) absence of changes, (j) absence of litigation, (k) employee benefit plans, (l) labor and employment matters, (m) real property, title of assets, (n) intellectual property, (o) taxes, (p) environmental matters, (q) material contracts, (r) international trade laws, (s) insurance, (t) board approval, vote required, (u) anti-corruption laws, (v) interested party transactions, (w) exchange act, (x) health care compliance, (y) brokers, (z) exclusivity.

### *Covenants*

The Business Combination Agreement includes customary covenants of the parties with respect to the operation of their respective businesses prior to the consummation of the Business Combination and efforts to satisfy the conditions to consummation of the Business Combination.

### *Incentive Plans*

In connection with the Merger, the parties will cooperate to establish, prior to the Closing an equity incentive award plan (the “Equity Plan”) for QTI Holdings with an award pool of GigCapital5 Common Stock equal to (i) eleven percent of the fully diluted shares of GigCapital5 Common Stock outstanding as of immediately after the Effective Time (rounded up to the nearest whole share) (the “Initial Equity Plan Pool”), which Equity Plan will include an “evergreen” provision pursuant to which such award pool will automatically increase on each January 1st that occurs within the ten year period following stockholder approval of such plan by an amount equal to five percent of the shares of GigCapital5 Common Stock outstanding as of 12:01 a.m. (Pacific Time) on such date, and which Equity Plan will be effective at and after the Closing. The parties expect that up to twenty-five percent of the Initial Equity Plan Pool would be reserved for issuance of awards by QTI Holdings to individuals who were employees or other service providers of QT Imaging as of the Closing and remain continuously employed or engaged by QTI Holdings at the time of the issuance of such awards following the Closing.

### *QT Imaging Exclusivity Restrictions*

Pursuant to the terms of the Business Combination Agreement, from the date of the Business Combination Agreement to the Closing or, if earlier, the termination of the Business Combination Agreement in accordance with its terms, QT Imaging has agreed, among other things, not to, directly or indirectly, (i) enter into, solicit, initiate or continue any discussions or negotiations with, or encourage or respond to any inquiries or proposals by, or participate in any negotiations with, or provide any information to, or otherwise cooperate in any way with, any person or other entity or “group” within the meaning of Section 13(d) of the Securities and Exchange Act of 1934, as amended (the “Exchange Act”), concerning (1) any sale of assets of QT Imaging, (2) the issuance or acquisition of the outstanding capital stock (on an as converted to Company Common Stock basis) or other voting securities of QT Imaging, or (3) any conversion, consolidation, merger, liquidation, dissolution or similar transaction (an “Alternative Transaction”), (ii) enter into any agreement regarding, continue or otherwise participate in any discussions regarding, or furnish to any person any information with respect to, or cooperate in any way that would otherwise reasonably be expected to lead to, any Alternative Transaction, or (iii) commence, continue or renew any due diligence investigation regarding any Alternative Transaction.

### *GigCapital5 Exclusivity Restrictions*

Pursuant to the terms of the Business Combination Agreement, from the date of the Business Combination Agreement to the Effective Time or, if earlier, the termination of the Business Combination Agreement in accordance with its terms, GigCapital5 has agreed among other things, not to take, whether directly or indirectly, any action to solicit, initiate, continue or engage in discussions or negotiations with, or enter into any agreement with, or encourage, respond, provide information to or commence due diligence with respect to, any person (other than QT Imaging, its stockholders and/or any of their affiliates or representatives), concerning, relating to or which is intended or is reasonably likely to give rise to or result in, any offer, inquiry, proposal or indication of interest, written or oral relating to any business combination transaction (a “Business Combination Proposal”) other than with QT Imaging, its stockholders and their respective affiliates and representatives.

### *PIPE Investment*

Following the date of the Business Combination Agreement through the Closing, GigCapital5 may enter into agreements with investors (the “PIPE Investors”) for the subscription for GigCapital5 Common Stock, convertible promissory notes or other securities or any combination of such securities to be subscribed for pursuant to the terms of one or more subscription agreements (all such subscription agreements, collectively the “PIPE Subscription Agreements”) on terms and conditions mutually agreeable to GigCapital5 and QT Imaging (such agreement not to be unreasonably withheld, conditioned or delayed), provided that, unless otherwise agreed to, the aggregate gross proceeds under the PIPE Subscription Agreements will not exceed \$26,000,000 (the “PIPE Investment Amount”).

## Conditions to Closing

The consummation of the Business Combination is subject to the receipt of the requisite approval of the stockholders of each of GigCapital5 and QT Imaging, and the fulfillment of certain other conditions, as described in greater detail below.

### Mutual Conditions

Under the terms of the Business Combination Agreement, the obligations of QT Imaging, GigCapital5 and Merger Sub to consummate the Business Combination, including the Merger, are subject to the satisfaction or waiver (where permissible) at or prior to the Closing of the following conditions: (i) the written consent of the stockholders of QT Imaging approving and adopting the Business Combination Agreement and the Merger and all other transactions contemplated by the Business Combination Agreement (the "Written Consent") will have been obtained and be in full force and effect; (ii) the GigCapital5 Proposals will have been approved and adopted by the requisite affirmative vote of the stockholders of GigCapital5 in accordance with the Proxy Statement, the General Corporation Law of the State of Delaware, the GigCapital5 Certificate of Incorporation, bylaws and other governing documents, and the rules and regulations of the Exchanges; (iii) no governmental authority will have enacted, issued, promulgated, enforced or entered any law, rule, regulation, judgment, decree, executive order or award which is then in effect and has the effect of making the Transactions illegal or otherwise prohibiting consummation of the transactions (the "Transactions") contemplated by the Business Combination Agreement and the other agreements described in this Current Report (the "Transaction Documents"); (iv) all applicable waiting periods (and any extensions of such waiting periods) under the Hart-Scott-Rodino Antitrust Improvements Act of 1976, as amended, in respect of the Transactions will have expired or been terminated; (v) all consents, approvals and authorizations set forth in the Business Combination Agreement will have been obtained from and made with all governmental authorities; (vi) the Registration Statement will have been declared effective under the Securities Act, no stop order suspending the effectiveness of the Registration Statement will be in effect, and no proceedings for purposes of suspending the effectiveness of the Registration Statement will have been initiated or threatened by the SEC; (vii) the shares of GigCapital5 Common Stock will be listed on an Exchange; and; (viii) upon the Closing, and after giving effect to the redemption rights provided for in Section 9.2 of Article IX of the GigCapital5 Certificate of Incorporation (the "Redemption Rights"), GigCapital5 will have net tangible assets of at least \$5,000,001 (excluding assets of the Surviving Corporation).

### GigCapital5 Conditions to Closing

Additionally, under the terms of the Business Combination Agreement, the obligations of GigCapital5 to consummate the Business Combination, including the Merger, are subject to the satisfaction or waiver (where permissible) at or prior to the Closing of, among other customary closing conditions, the following conditions: (i) the representation and warranties of QT Imaging contained in the Business Combination Agreement will be true and correct in all material respects, or in all respects, as applicable; (ii) QT Imaging will have performed or complied in all material respects with all agreements and covenants required by the Business Combination Agreement to be performed, or complied with by it; (iii) QT Imaging will have delivered to GigCapital5 a certificate signed by an officer of QT Imaging certifying as to the satisfaction of certain of the conditions specified in the Business Combination Agreement; (iv) no Company Material Adverse Effect will have occurred between the date of the Business Combination Agreement and the date of the Closing (the "Closing Date"); (v) other than those persons identified as continuing directors, all members of the board of directors of QT Imaging will have executed written resignations; (vi) the Stockholder Support Agreement (as defined below) will be in full force and effect, and no stockholder of QT Imaging that is a party to the Stockholder Support Agreement (the "Key Company Stockholders") will have attempted to repudiate or disclaim any of its or his/her obligations thereunder; (vii) all parties to the Registration Rights Agreement (as defined below) (other than GigCapital5) will have delivered, or cause to be delivered, to GigCapital5 copies of the Registration Rights Agreement duly executed by all such parties; (viii) QT Imaging will have delivered to GigCapital5 the Lock-Up Agreement (as defined below) duly executed by each holder of shares of Company Common Stock outstanding as of immediately prior to the Effective Time, other than any such holder who, as of immediately prior to the Effective Time, owns (together with his, her or its Affiliates) an aggregate of less than three percent of all shares of Company Common Stock then outstanding; (ix) QT Imaging will deliver to GigCapital5 a properly executed certification that shares of Company Common Stock are not "U.S. real property interests" in accordance with the Treasury Regulations under Sections 897 and



1445 of the Internal Revenue Code of 1986, as amended (the “Internal Revenue Code”), together with a notice to the Internal Revenue Service (the “IRS”) (which will be filed by GigCapital5 with the IRS following the Closing) in accordance with the provisions of Section 1.897-2(h)(2) of the U.S. Treasury regulations issued pursuant to the Internal Revenue Code; (x) QT Imaging will have delivered to GigCapital5 the PCAOB Financial Statements; (xi) QT Imaging Warrants (other than In-the-Money Company Warrants) will have been amended such that such Company Warrants will be canceled without consideration upon the Closing and the In-the-Money Company Warrants will have been canceled, extinguished and exercised for shares of Company Common Stock in accordance with their terms, or will be capable of being assumed by GigCapital5 in accordance with their terms; (xii) the Converting Notes will have been converted into Company Common Stock immediately prior to the Effective Time and the other Company Convertible Notes will have been repaid or amended to provide that they will be assumed by QTI Holdings and not be convertible into shares or other securities of any entity and will not be subject to a lien or security interest and all liens and security interests currently granted in favor of the holders of such Company Convertible Notes will be terminated as of the Closing; (xiii) the debt of QT Imaging as of immediately prior to the Effective Time after conversion of any Converting Notes will be no more than \$4,000,000; and (xiv) the Transaction Documents will be in full force and effect and will not have been rescinded by QT Imaging.

#### QT Imaging Conditions to Closing

Additionally, under the terms of the Business Combination Agreement, the obligations of QT Imaging to consummate the Business Combination, including the Merger, are subject to the satisfaction or waiver (where permissible) at or prior to the Closing of, among other customary closing conditions, the following conditions: (i) the representation and warranties of GigCapital5 and Merger Sub contained in the Business Combination Agreement will be true and correct in all material respects, or in all respects, as applicable; (ii) GigCapital5 and Merger Sub will have performed or complied in all material respects with all agreements and covenants required by the Business Combination Agreement to be performed, or complied with by them; (iii) the GigCapital5 will have delivered to QT Imaging a certificate signed by the President of GigCapital5 certifying as to the satisfaction of certain of the conditions specified in the Business Combination Agreement; (iv) no GigCapital5 Material Adverse Effect will have occurred between the date of the Business Combination Agreement and the Closing Date; (v) the Available Cash (as defined below) will be equal or greater than \$15,000,000; (vi) GigCapital5 will have taken all such actions as reasonable required such that, immediately following the Closing, the QTI Holdings Board will consist of the directors as indicated in the Business Combination Agreement; (vii) all current and long-term liabilities of GigCapital5 will, immediately prior to the Closing, be capable of being satisfied as part of the Unpaid GigCapital5 Transaction Expenses (as defined below); (viii) a supplemental listing will have been filed with an Exchange, as applicable, as of the Closing Date to list the shares constituting the Aggregate Closing Merger Consideration; (ix) GigCapital5 will have delivered a copy of the Registration Rights Agreement duly executed by GigCapital5 and the Sponsor (as defined below); (x) GigCapital5 will have delivered a copy of the Lock-Up Agreement duly executed by GigCapital5 and the Sponsor; (xi) the transactions contemplated by the Sponsor Support Agreement to occur at or prior to the Closing will have been consummated; and (xii) the Transaction Documents will be in full force and effect and will not have been rescinded by GigCapital5 or Merger Sub.

The term “Available Cash” means, as of immediately prior the Closing, an amount of cash equal to: (a) the sum of (i) the funds in the trust account established by GigCapital5 for the benefit of its public stockholders following the exercise of any Redemption Rights by such public stockholders of GigCapital5, plus (ii) cash available to GigCapital5 from any other sources, including the PIPE Investment Amounts, plus (iii) the Company Closing Cash, minus (b) (i) the Company Transaction Expenses that are not Paid Company Transaction Expenses (other than any such Company Transaction Expenses to be satisfied by the issuance of shares of GigCapital5 Common Stock, including the Aggregate Excess Company Transaction Expenses Shares) and (ii) the amount of transaction expenses of GigCapital5 or Merger Sub incurred by or on its behalf in connection with the preparation, negotiation and execution of the Business Combination Agreement and the consummation of the transactions that the Business Combination Agreement contemplates to be paid at the Closing and costs and expenses payable to the provider of a buyer-side representation and warranty insurance policy to be obtained by GigCapital5, each of which have not been paid as of the Closing (the “Unpaid GigCapital5 Transaction Expenses”) (other than any such Unpaid GigCapital5 Transaction Expenses to be satisfied by the issuance of shares of GigCapital5 Common Stock to the extent that the aggregate amount of such expenses exceeds \$7,000,000).

## Termination

The Business Combination Agreement allows the parties to terminate the agreement if certain conditions described in the Business Combination Agreement are satisfied, including (i) by mutual written consent of GigCapital5 and QT Imaging; (ii) by written notice by either GigCapital5 or QT Imaging if the Effective Time has not occurred by September 8, 2023, the date which is nine months after the date of the Business Combination Agreement (the “Outside Date”); (iii) by written notice by either GigCapital5 or QT Imaging if any governmental authority of competent jurisdiction in the United States will have enacted, issued, promulgated, enforced, or entered any injunction, order, decree or ruling (whether temporary, preliminary or permanent) which has become final and non-appealable and has the effect of making consummation of the Transactions, including the Merger, illegal or otherwise preventing or prohibiting consummation of the Transactions or the Merger; (iv) by written notice by either GigCapital5 or QT Imaging to the other party, if any of the GigCapital5 Proposals will fail to receive the requisite vote for approval at the GigCapital5 Stockholders’ Meeting; (v) by written notice by GigCapital5 to QT Imaging, if QT Imaging will have failed to deliver the Written Consent to GigCapital5; (vi) by written notice by GigCapital5 to QT Imaging upon a breach of any representation, warranty, covenant or agreement on the part of QT Imaging set forth in the Business Combination Agreement, or if any representation or warranty of QT Imaging will have become untrue; (vii) by written notice by QT Imaging to GigCapital5 upon a breach of any representation, warranty, covenant or agreement on the part of GigCapital5 or Merger Sub set forth in the Business Combination Agreement, or if any representation or warranty of GigCapital5 or Merger Sub will have become untrue; or (viii) by written notice by either GigCapital5 or QT Imaging to the other party, if after giving effect to the Redemption Rights, GigCapital5 does not have net tangible assets of at least \$5,000,001 (excluding assets of the Surviving Corporation).

## Stockholder Support Agreement

GigCapital5, QT Imaging, and the Key Company Stockholders, concurrently with the execution and delivery of the Business Combination Agreement, have entered into the Stockholder Support Agreement (the “Stockholder Support Agreement”), pursuant to which such Key Company Stockholders holding at least fifty and one tenth percent of the Company Common Stock have agreed, among other things, to vote all of their shares of QT Imaging in favor of the Business Combination Agreement and the Business Combination, including the Merger.

The foregoing description of the Stockholder Support Agreement and the transactions contemplated thereby is not complete and is subject to, and qualified in its entirety by reference to, the actual agreement, a copy of which is filed with this Current Report as Exhibit 10.1, and the terms of which are incorporated into this Current Report by reference.

## Sponsor Support Agreement

GigCapital5, its sponsor, GigAcquisitions5, LLC (the “Sponsor”) and QT Imaging have entered into the Sponsor Support Agreement (the “Sponsor Support Agreement”), pursuant to which the Sponsor has agreed, among other things, to vote (or execute and return an action by written consent), or cause to be voted at the GigCapital5 Stockholders’ Meeting (as defined in the Sponsor Support Agreement) (or validly execute and return and cause such consent to be granted with respect to), all of its shares of GigCapital5 Common Stock in favor of the approval and adoption of the Business Combination Agreement and approval of the Business Combination, including the Merger.

The foregoing description of the Sponsor Support Agreement and the transactions contemplated thereby is not complete and is subject to, and qualified in its entirety by reference to, the actual agreement, a copy of which is filed with this Current Report as Exhibit 10.2, and the terms of which are incorporated into this Current Report by reference.

## Registration Rights Agreement

In connection with the Business Combination, GigCapital5 and certain stockholders of QT Imaging (the “Holders”) will enter into a Registration Rights Agreement (the “Registration Rights Agreement”) at the Closing. Pursuant to the terms of the Registration Rights Agreement, QTI Holdings will be obligated to file one or more registration statements to register the resales of GigCapital5 Common Stock held by such Holders after the Closing. Holders holding at least majority in interest of the registrable securities owned by all Holders are entitled under the Registration Rights Agreement to make a written demand for registration under the Securities Act of all or part of

their registrable securities, up to a total of three such demands. In addition, pursuant to the terms of the Registration Rights Agreement and subject to certain requirements and customary conditions, such Holders may demand at any time or from time to time, that QTI Holdings file a registration statement on Form S-3 (or any similar short-form registration which may be available) to register the resale of the registrable securities of QTI Holdings held by such Holders. The Registration Rights Agreement will also provide such Holders with “piggy-back” registration rights, subject to certain requirements and customary conditions.

Under the Registration Rights Agreement, QTI Holdings will indemnify such Holders and certain persons or entities related to such Holders such as their officers, employees, directors, and agents against any losses or damages resulting from any untrue or alleged untrue statement, or omission or alleged omission, of a material fact in any registration statement or prospectus pursuant to which the Holders sell their registrable securities, unless such liability arose from such Holder’s misstatement or alleged misstatement, or omission or alleged omission, and the Holders including registrable securities in any registration statement or prospectus will indemnify QTI Holdings and certain persons or entities related to QTI Holdings such as its officers and directors and underwriters against all losses caused by their misstatements or omissions (or alleged misstatements or omissions) in those documents

The foregoing description of the Registration Rights Agreement and the transactions contemplated by the Registration Rights Agreement is not complete and is subject to, and qualified in its entirety by reference to, the agreed upon form of Registration Rights Agreement, a copy of which is filed with this Current Report on Form 8-K as [Exhibit C](#) to [Exhibit 2.1](#) to this Current Report, and the terms of which are incorporated into this Current Report by reference.

#### **Lock-Up Agreement**

In connection with the Business Combination, GigCapital5 and the Holders will enter into the Lock-Up Agreement. The Lock-Up Agreement will provide that, subject to certain exceptions, each of the Holders will not transfer any shares of GigCapital5 Common Stock beneficially owned or owned of record by such of the Holders until the earlier of (a) six months following the Closing Date; (b) subsequent to the Closing, the date on which the reported closing price of one share of GigCapital5 Common Stock quoted on the Exchange on which the shares of GigCapital5 Common Stock are then listed equals or exceeds \$11.50 per share (as adjusted for stock splits, stock dividends, reorganizations, recapitalizations and the like occurring after the Closing Date) for any twenty trading days within any thirty consecutive trading day period commencing at least ninety days after the Closing Date; and (c) subsequent to the Closing, the date on which GigCapital5 completes a liquidation, merger, stock exchange or other similar transaction that results in all of GigCapital5’s stockholders having the right to exchange their GigCapital5 securities for cash, securities or other property.

The foregoing description of the Lock-Up Agreement and the transactions contemplated by the Lock-Up Agreement is not complete and is subject to, and qualified in its entirety by reference to, the agreed upon form of Lock-Up Agreement, a copy of which is filed with this Current Report on Form 8-K as [Exhibit D](#) to [Exhibit 2.1](#) to this Current Report, and the terms of which are incorporated into this Current Report by reference.

#### **Item 7.01 Regulation FD Disclosure.**

On December 12, 2022, GigCapital5 and QT Imaging issued a joint press release announcing the Business Combination Agreement. The press release is attached to this Current Report as [Exhibit 99.1](#) and incorporated by reference into this Current Report.

Furnished as [Exhibit 99.2](#) to this Current Report and incorporated into this Item 7.01 by reference is the investor presentation that GigCapital5 and QT Imaging have prepared for use in connection with the announcement of the Business Combination Agreement.

The foregoing (including [Exhibits 99.1](#) and [99.2](#)) is being furnished pursuant to Item 7.01 and will not be deemed to be filed for purposes of Section 18 of the Exchange Act, or otherwise subject to the liabilities of that section, and will not be deemed to be incorporated by reference into the filings of GigCapital5 under the Securities Act or the Exchange Act, regardless of any general incorporation language in such filings.

### **Additional Information and Where to Find It**

In connection with the proposed Business Combinations, GigCapital5 intends to file with the SEC the Registration Statement, which will include a preliminary Proxy Statement to be distributed to holders of GigCapital5 Common Stock in connection with GigCapital5's solicitation of proxies for the vote by GigCapital5's stockholders with respect to the Business Combination and the other matters as described in the Registration Statement and a prospectus relating to the offer of the securities to be issued to the stockholders of QT Imaging in connection with the Business Combination. After the Registration Statement has been filed and declared effective, GigCapital5 will mail a definitive Proxy Statement, when available, to its stockholders. Investors and security holders and other interested parties are urged to read the Proxy Statement, any amendments thereto and any other documents filed with the SEC carefully and in their entirety when they become available because they will contain important information about GigCapital5, QT Imaging and the proposed Business Combination. Such persons can also read GigCapital5's Annual Report on Form 10-K and Form 8-K reports for more information on the security holdings of its officers and directors and their respective interests as security holders in the consummation of the Transactions described in this Current Report. The Proxy Statement and Registration Statement, once available, and GigCapital5's other reports can be obtained, without charge, at the SEC's web site ([www.sec.gov](http://www.sec.gov)) and on GigCapital5's website at [www.gigcapital5.com](http://www.gigcapital5.com).

### **Participants in the Solicitation**

GigCapital5, QT Imaging, and their respective directors, executive officers and other members of their management and employees, under SEC rules, may be deemed to be participants in the solicitation of proxies of GigCapital5 stockholders in connection with the proposed business combination. Investors and security holders may obtain more detailed information regarding the names, affiliations and interests of GigCapital5's directors and officers in its Annual Report on Form 10-K for the fiscal year ended December 31, 2021, which was filed with the SEC on March 31, 2022. Information regarding the persons who may, under SEC rules, be deemed participants in the solicitation of proxies to GigCapital5's stockholders in connection with the proposed business combination will be set forth in the Proxy Statement for the proposed Business Combination when available. Information concerning the interests of GigCapital5's and QT Imaging's equity holders and participants in the solicitation, which may, in some cases, be different than those of GigCapital5's and QT Imaging's equity holders generally, will be set forth in the Proxy Statement relating to the proposed Business Combination when it becomes available. GigCapital5 stockholders, potential investors and other interested persons should read the Proxy Statement carefully when it becomes available before making any voting or investment decisions.

### **Forward-Looking Statements:**

This Current Report includes "forward-looking statements" within the meaning of the "safe harbor" provisions of the Private Securities Litigation Reform Act of 1995. The expectations, estimates, and projections of the businesses of GigCapital5 and QT Imaging may differ from their actual results and consequently, you should not rely on these forward-looking statements as predictions of future events. Words such as "expect," "estimate," "project," "budget," "forecast," "anticipate," "intend," "plan," "may," "will," "could," "should," "believes," "predicts," "potential," "continue," and similar expressions are intended to identify such forward-looking statements. These forward-looking statements include, without limitation, expectations of the management of QT Imaging with respect to the business and prospects of QT Imaging and the QTscan® and other products of QT Imaging, the benefits of the proposed Business Combination, the plans, expectations and intentions of QT Imaging and GigCapital5, the satisfaction of the closing conditions to the proposed Business Combination, the timing of the completion of the proposed Business Combination and the future performance of QT Imaging, including the anticipated impact of the proposed Business Combination on this performance. These forward-looking statements involve significant risks and uncertainties that could cause the actual results to differ materially from the expected results. Most of these factors are outside of the control of GigCapital5 and QT Imaging and are difficult to predict. Factors that may cause such differences include, but are not limited to: (1) the ability of GigCapital5, QT Imaging and QTI Holdings to issue equity or equity-linked securities in connection with the proposed Business Combination or in the future, (2) the outcome of any legal proceedings that may be instituted against the parties following the announcement of the proposed Business Combination and the Business Combination Agreement; (3) the inability to complete the proposed Business Combination, including the risk that any regulatory approvals or the SEC's declaration of the effectiveness of the Proxy Statement are not obtained, are delayed or are subject to unanticipated conditions that

could adversely affect QTI Holdings or the expected benefits of the proposed Business Combination or due to failure to obtain approval of the stockholders of GigCapital5 and QT Imaging or other conditions to closing; (4) the amount of redemption requests made by GigCapital5's stockholders; (5) the impact of the COVID-19 pandemic on (x) the parties' ability to consummate the proposed Business Combination and (y) the business of QT Imaging and QTI Holdings; (6) the receipt of an unsolicited offer from another party for an alternative business transaction that could interfere with the proposed Business Combination; (7) the inability to obtain or maintain the listing of QTI Holdings' common stock on the New York Stock Exchange or any other Exchange following the proposed Business Combination; (8) the risk that the proposed Business Combination disrupts current plans and operations as a result of the announcement and consummation of the proposed Business Combination; (9) the ability to recognize the anticipated benefits of the proposed Business Combination, which may be affected by, among other things, competition, the ability of QTI Holdings to grow and manage growth profitably and retain its key employees; (10) costs related to the proposed Business Combination; (11) changes in applicable laws or regulations; (12) the demand for QT Imaging's and QTI Holdings' services together with the possibility that QT Imaging or QTI Holdings may be adversely affected by other economic, business, and/or competitive factors; (13) risks and uncertainties related to QT Imaging's business, including, but not limited to, the ability of QT Imaging to increase sales of its output products in accordance with its plan; (14) risks related to the rollout of QT Imaging's business and the timing of expected business milestones; (15) the effects of competition on QT Imaging's business; (16) changes in domestic and foreign business, market, financial, political, and legal conditions; and (17) other risks and uncertainties included in (x) the "Risk Factors" sections of the most recent Annual Report on Form 10-K and Quarterly Reports on Form 10-Q filed with the SEC by GigCapital5 and (y) other documents filed or to be filed with the SEC by GigCapital5. The foregoing list of factors is not exclusive. You should not place undue reliance upon any forward-looking statements, which speak only as of the date made. GigCapital5 and QT Imaging do not undertake or accept any obligation or undertaking to release publicly any updates or revisions to any forward-looking statements to reflect any change in their expectations or any change in events, conditions, or circumstances on which any such statement is based.

#### **No Offer or Solicitation**

This Current Report will not constitute a solicitation of a proxy, consent or authorization with respect to any securities or in respect of the Business Combination. This Current Report will also not constitute an offer to sell or the solicitation of an offer to buy any securities, nor will there be any sale of securities in any states or jurisdictions in which such offer, solicitation or sale would be unlawful prior to registration or qualification under the securities laws of any such jurisdiction. No offering of securities will be made except by means of a prospectus meeting the requirements of Section 10 of the Securities Act or an exemption therefrom.

**Item 9.01 Financial Statements and Exhibits.**

(d) Exhibits:

<b>Exhibit</b>	<b>Description</b>
2.1†	Business Combination Agreement, dated as of December 8, 2022, by and among GigCapital5, Inc., QTI Merger Sub, Inc. and QT Imaging, Inc.
10.1†	Stockholder Support Agreement, dated as of December 8, 2022, by and among GigCapital5, QT Imaging, Inc. and certain stockholders of QT Imaging, Inc. named in the Stockholder Support Agreement.
10.2	Sponsor Support Agreement, dated as of December 8, 2022, by and among GigCapital5, GigAcquisitions5, LLC, and QT Imaging, Inc.
99.1	Press Release, dated December 12, 2022
99.2	Investor Presentation, dated December 12, 2022
104	Cover Page Interactive Data File (embedded within the Inline XBRL document)
†	Certain of the exhibits and schedules to this exhibit have been omitted in accordance with Regulation S-K Item 601(b)(2). The Registrant agrees to furnish supplementally a copy of all omitted exhibits and schedules to the SEC upon its request.

**SIGNATURE**

Pursuant to the requirements of the Securities Exchange Act of 1934, as amended, the registrant has duly caused this report to be signed on its behalf by the undersigned hereunto duly authorized.

Dated: December 12, 2022

**GIGCAPITAL5, INC.**

By: /s/ Dr. Raluca Dinu

Name: Dr. Raluca Dinu

Title: Chief Executive Officer, President and Secretary

BUSINESS COMBINATION AGREEMENT

by and among

GIGCAPITAL5, INC.,

QTI MERGER SUB, INC.,

and

QT IMAGING, INC.

Dated as of December 8, 2022



## Table of Contents

	Page
ARTICLE I. DEFINITIONS	2
<b>SECTION 1.01</b> Certain Definitions.	2
<b>SECTION 1.02</b> Further Definitions	13
<b>SECTION 1.03</b> Construction.	15
ARTICLE II. AGREEMENT AND PLAN OF MERGER	16
<b>SECTION 2.01</b> The Merger	16
<b>SECTION 2.02</b> Effective Time; Closing.	16
<b>SECTION 2.03</b> Effect of the Merger	16
<b>SECTION 2.04</b> Certificate of Incorporation; Bylaws.	16
<b>SECTION 2.05</b> Directors and Officers.	17
ARTICLE III. EFFECTS OF THE MERGER	18
<b>SECTION 3.01</b> Conversion of Securities	18
<b>SECTION 3.02</b> Delivery of Shares.	19
<b>SECTION 3.03</b> Stock Transfer Books	21
<b>SECTION 3.04</b> Payment of Expenses.	21
<b>SECTION 3.05</b> Appraisal Rights.	23
<b>SECTION 3.06</b> Closing Calculations.	23
<b>SECTION 3.07</b> Earnout.	24
ARTICLE IV. REPRESENTATIONS AND WARRANTIES OF THE COMPANY	26
<b>SECTION 4.01</b> Organization and Qualification; Subsidiaries.	26
<b>SECTION 4.02</b> Certificate of Incorporation and Bylaws	26
<b>SECTION 4.03</b> Capitalization.	26
<b>SECTION 4.04</b> Authority Relative to this Agreement	28
<b>SECTION 4.05</b> No Conflict; Required Filings and Consents.	29
<b>SECTION 4.06</b> Permits; Compliance	29
<b>SECTION 4.07</b> Regulatory Matters.	29
<b>SECTION 4.08</b> Financial Statements.	31
<b>SECTION 4.09</b> Absence of Certain Changes or Events	32
<b>SECTION 4.10</b> Absence of Litigation	32
<b>SECTION 4.11</b> Employee Benefit Plans.	33
<b>SECTION 4.12</b> Labor and Employment Matters.	35
<b>SECTION 4.13</b> Real Property; Title to Assets.	36
<b>SECTION 4.14</b> Intellectual Property.	37
<b>SECTION 4.15</b> Taxes.	42
<b>SECTION 4.16</b> Environmental Matters	44
<b>SECTION 4.17</b> Material Contracts.	45
<b>SECTION 4.18</b> International Trade Laws.	46
<b>SECTION 4.19</b> Insurance.	48
<b>SECTION 4.20</b> Board Approval; Vote Required	48
<b>SECTION 4.21</b> Compliance with Anti-Corruption Laws	48
<b>SECTION 4.22</b> Interested Party Transactions	49
<b>SECTION 4.23</b> Exchange Act	49
<b>SECTION 4.24</b> Health Care Compliance.	49
<b>SECTION 4.25</b> Brokers	51
<b>SECTION 4.26</b> Exclusivity of Representations and Warranties	51
ARTICLE V. REPRESENTATIONS AND WARRANTIES OF GIGCAPITAL5 AND MERGER SUB	51
<b>SECTION 5.01</b> Corporate Organization.	51
<b>SECTION 5.02</b> Certificate of Incorporation and Bylaws	51
<b>SECTION 5.03</b> Capitalization.	52

**Table of Contents**  
**(continued)**

	<b>Page</b>
<b>SECTION 5.04</b> Authority Relative to This Agreement	53
<b>SECTION 5.05</b> No Conflict; Required Filings and Consents.	53
<b>SECTION 5.06</b> Compliance	53
<b>SECTION 5.07</b> SEC Filings; Financial Statements; Sarbanes-Oxley.	54
<b>SECTION 5.08</b> Absence of Certain Changes or Events	55
<b>SECTION 5.09</b> Business Activities	55
<b>SECTION 5.10</b> Investment Company Act	56
<b>SECTION 5.11</b> Affiliate Agreements	56
<b>SECTION 5.12</b> Sponsor Support Agreement	56
<b>SECTION 5.13</b> Absence of Litigation	56
<b>SECTION 5.14</b> Board Approval; Vote Required.	56
<b>SECTION 5.15</b> No Prior Operations of Merger Sub	57
<b>SECTION 5.16</b> Brokers	57
<b>SECTION 5.17</b> GigCapital5 Trust Fund	57
<b>SECTION 5.18</b> Employees	58
<b>SECTION 5.19</b> Taxes.	58
<b>SECTION 5.20</b> Listing	59
<b>SECTION 5.21</b> GigCapital5's and Merger Sub's Investigation and Reliance	60
<b>ARTICLE VI. CONDUCT OF BUSINESS PENDING THE MERGER</b>	60
<b>SECTION 6.01</b> Conduct of Business by the Company Pending the Merger.	60
<b>SECTION 6.02</b> Conduct of Business by GigCapital5 and Merger Sub Pending the Merger	62
<b>SECTION 6.03</b> Claims Against Trust Account	64
<b>ARTICLE VII. ADDITIONAL AGREEMENTS</b>	64
<b>SECTION 7.01</b> Proxy Statement; Registration Statement.	64
<b>SECTION 7.02</b> GigCapital5 Stockholders' Meetings; and Merger Sub Stockholder's Approval.	66
<b>SECTION 7.03</b> Company Stockholders' Written Consent	66
<b>SECTION 7.04</b> Access to Information; Confidentiality.	66
<b>SECTION 7.05</b> Exclusivity	67
<b>SECTION 7.06</b> Employee Benefits Matters	68
<b>SECTION 7.07</b> Directors' and Officers' Indemnification; Tail Insurance	68
<b>SECTION 7.08</b> Notification of Certain Matters	69
<b>SECTION 7.09</b> Further Action; Reasonable Best Efforts	69
<b>SECTION 7.10</b> Public Announcements	70
<b>SECTION 7.11</b> Tax Matters	70
<b>SECTION 7.12</b> Stock Exchange Listing	71
<b>SECTION 7.13</b> Antitrust.	71
<b>SECTION 7.14</b> PCAOB Financial Statements	72
<b>SECTION 7.15</b> Trust Account	72
<b>SECTION 7.16</b> Section 16 Matters	72
<b>SECTION 7.17</b> Company Warrants	72
<b>SECTION 7.18</b> Company Convertible Notes	72
<b>SECTION 7.19</b> Insurance	73
<b>SECTION 7.20</b> Financing	73
<b>ARTICLE VIII. CONDITIONS TO THE MERGER</b>	73
<b>SECTION 8.01</b> Conditions to the Obligations of Each Party	73
<b>SECTION 8.02</b> Conditions to the Obligations of GigCapital5 and Merger Sub	74
<b>SECTION 8.03</b> Conditions to the Obligations of the Company	75

**Table of Contents**  
**(continued)**

	<b>Page</b>
ARTICLE IX. TERMINATION, AMENDMENT AND WAIVER	76
<b>SECTION 9.01</b> Termination	76
<b>SECTION 9.02</b> Effect of Termination	77
<b>SECTION 9.03</b> Expenses	77
<b>SECTION 9.04</b> Amendment	77
<b>SECTION 9.05</b> Waiver	78
ARTICLE X. GENERAL PROVISIONS	78
<b>SECTION 10.01</b> Notices	78
<b>SECTION 10.02</b> Non-survival of Representations, Warranties and Covenants	79
<b>SECTION 10.03</b> Severability	80
<b>SECTION 10.04</b> Entire Agreement; Assignment	80
<b>SECTION 10.05</b> Parties in Interest	80
<b>SECTION 10.06</b> Governing Law	80
<b>SECTION 10.07</b> WAIVER OF JURY TRIAL	80
<b>SECTION 10.08</b> Headings	81
<b>SECTION 10.09</b> Counterparts	81
<b>SECTION 10.10</b> Non-Recourse	81
<b>SECTION 10.11</b> Specific Performance	81
EXHIBIT A	Sponsor Support Agreement
EXHIBIT B	Stockholder Support Agreement
EXHIBIT C	Registration Rights Agreement
EXHIBIT D	Lock-Up Agreement
EXHIBIT E	Surviving Corporation Amended and Restated Certificate of Incorporation
EXHIBIT F	GigCapital5 Second Amended and Restated Certificate of Incorporation
SCHEDULE 1.01	Company Knowledge Parties
SCHEDULE 2.05	Initial Post-Closing QTI Holdings Directors
SCHEDULE 3.04(g)	Certain Unpaid Company Transaction Expenses
SCHEDULE 6.01	Conduct of Business by the Company Pending the Merger
SCHEDULE 7.03	Key Company Stockholders

BUSINESS COMBINATION AGREEMENT, dated as of December 8, 2022 (this "Agreement"), by and among GigCapital5, Inc., a Delaware corporation ("GigCapital5"), QTI Merger Sub, Inc., a Delaware corporation ("Merger Sub"), and QT Imaging, Inc., a Delaware corporation (the "Company"). GigCapital5, Merger Sub and the Company are sometimes referred to herein individually as a "party" and, collectively, as the "parties."

WHEREAS, Merger Sub is a wholly-owned direct Subsidiary of GigCapital5;

WHEREAS, upon the terms and subject to the conditions of this Agreement and in accordance with the General Corporation Law of the State of Delaware (the "DGCL"), GigCapital5 and the Company will enter into a business combination transaction pursuant to which Merger Sub will merge with and into the Company (the "Merger"), with the Company surviving the Merger as a wholly owned, privately-held subsidiary of GigCapital5, and GigCapital5 will change its name to QT Imaging Holdings, Inc., which will continue as the surviving public corporation after the Closing ("QTI Holdings");

WHEREAS, the Board of Directors of the Company (the "Company Board") has unanimously (a) determined that the Merger is fair to, and in the best interests of, the Company and its stockholders and has approved and adopted this Agreement and approved the Merger and the other transactions contemplated by this Agreement, and (b) recommended the approval and adoption of this Agreement and the Merger by the stockholders of the Company once the Registration Statement (as defined below) has been declared effective;

WHEREAS, the Board of Directors of GigCapital5 (the "GigCapital5 Board") has (a) approved and adopted this Agreement and declared its advisability and approved the payment of the Per Share Merger Consideration to stockholders of the Company pursuant to this Agreement and the other transactions contemplated by this Agreement, and (b) recommended the approval and adoption of this Agreement and the transactions contemplated by this Agreement by the stockholders of GigCapital5;

WHEREAS, the Board of Directors of Merger Sub (the "Merger Sub Board") has (a) determined that the Merger is fair to, and in the best interests of, Merger Sub and its sole stockholder and has approved and adopted this Agreement and declared its advisability and approved the Merger and the other transactions contemplated by this Agreement, and (b) recommended the approval and adoption of this Agreement and the Merger by the sole stockholder of Merger Sub;

WHEREAS, in connection with the transactions contemplated by this Agreement, GigAcquisitions5, LLC, a Delaware limited liability company (the "Sponsor") and GigCapital5 shall enter into a Sponsor Support Agreement substantially in the form attached hereto as Exhibit A (the "Sponsor Support Agreement"), providing that, among other things, the Sponsor will vote its shares of GigCapital5 Common Stock in favor of this Agreement, the Merger and the other transactions contemplated by this Agreement;

WHEREAS, GigCapital5, the Company and the Key Company Stockholders (as defined herein), concurrently with the execution and delivery of this Agreement, are entering into the Stockholder Support Agreement substantially in the form attached hereto as Exhibit B (the "Stockholder Support Agreement"), providing that, among other things, Key Company Stockholders holding at least fifty and one tenth percent (50.1%) of the Company Common Stock will vote their shares of Company Common Stock in favor of this Agreement, the Merger and the other transactions contemplated by this Agreement;

WHEREAS, in connection with the Closing, GigCapital5 and certain stockholders of the Company holding three percent (3%) or more of the Company Common Stock outstanding as of immediately prior to the Effective Time (as defined below) shall enter into a Registration Rights Agreement substantially in the form attached hereto as Exhibit C (the "Registration Rights Agreement") and a Lock-Up Agreement substantially in the form attached hereto as Exhibit D (the "Lock-Up Agreement"); and

WHEREAS, for United States federal income tax purposes, it is intended that the Merger qualify as a reorganization within the meaning of Section 368(a) of the Code, that the Company, Merger Sub and GigCapital5 are parties to such reorganization within the meaning of Section 368(b) of the Code and that this Agreement constitutes a “plan of reorganization” within the meaning of Section 1.368-2(g) and 1.368-3(a) of the Treasury Regulations (the “Intended Tax Treatment”).

NOW, THEREFORE, in consideration of the foregoing and the mutual covenants and agreements herein contained, and intending to be legally bound hereby, the parties hereto hereby agree as follows:

## **ARTICLE I. DEFINITIONS**

**SECTION 1.01 Certain Definitions.** For purposes of this Agreement:

“Affiliate” of a specified person means a person who, directly or indirectly through one or more intermediaries, controls, is controlled by, or is under common control with, such specified person.

“Aggregate Closing Merger Consideration” means a number of shares of GigCapital5 Common Stock equal to the difference of: (a) the quotient of (i) the Aggregate Closing Merger Consideration Value, *divided by* (ii) \$10.00; *minus* (b) the Aggregate Excess Company Transaction Expenses Shares.

“Aggregate Closing Merger Consideration Value” means: (a) the sum of (i) \$151,000,000, *plus* (ii) the Aggregate Exercise Price, *plus* (iii) the Company Closing Cash; *plus* (iv) the Paid Company Transaction Expenses; *minus* (b) the Company Closing Debt, which shall not exceed \$4,000,000.

“Aggregate Excess Company Transaction Expenses Shares” means a number of shares of GigCapital5 Common Stock equal to the quotient of (a) the amount of Company Transaction Expenses in excess of the Company Transaction Expenses Cap, if any, *divided by* (b) \$10.00, and rounded up to the nearest whole share, and shall include all shares to be issued to Exit Strategy Partners, LLC and ARC Group Limited as partial payment of the Company Transaction Expenses for such entities.

“Aggregate Excess GigCapital5 Transaction Expenses Shares” means a number of shares of GigCapital5 Common Stock equal to the quotient of (a) the amount of GigCapital5 Transaction Expenses in excess of the GigCapital5 Transaction Expenses Cap, if any, *divided by* (b) \$10.00, and rounded up to the nearest whole share.

“Aggregate Exercise Price” means the sum of the exercise prices of all In-the-Money Company Warrants outstanding immediately prior to the Effective Time.

“Ancillary Agreements” means the Stockholder Support Agreement, the Sponsor Support Agreement, the Registration Rights Agreement, the Lock-Up Agreement, and all other agreements, certificates and instruments executed and delivered by GigCapital5, Merger Sub or the Company in connection with the Transactions and specifically contemplated by this Agreement.

“Anti-Corruption Laws” means the U.S. Foreign Corrupt Practices Act of 1977, as amended, the U.K. Bribery Act of 2010, and any other applicable anti-corruption/anti-bribery laws and regulations.

“Available Cash” means, as of immediately prior the Closing, an amount of cash and cash equivalents equal to: (a) the sum of (i) the funds in the Trust Account following the exercise of any Redemption Rights by the stockholders of GigCapital5, *plus* (ii) cash and cash equivalents available to GigCapital5 from any other

sources, including the proceeds of any equity or debt financing arrangement to be entered into by GigCapital5 following the date of this Agreement and consummated in connection with the Closing, *plus* (iii) Company Closing Cash; *minus* (b) the Unpaid Company Transaction Expenses (other than any such Unpaid Company Transaction Expenses to be satisfied by the issuance of shares of GigCapital5 Common Stock pursuant to the provisions of [Section 3.04\(d\)](#) and [Section 3.04\(g\)](#)) and the Unpaid GigCapital5 Transaction Expenses (other than any such Unpaid GigCapital5 Transaction Expenses to be satisfied by the issuance of shares of GigCapital5 Common Stock pursuant to the provisions of [Section 3.04\(e\)](#)).

“[Bridge Financing](#)” means a financing of the Company on terms and conditions previously approved in writing by GigCapital5, pursuant to which the Company would (a) obtain financing in an aggregate principal amount not to exceed \$4,000,000, and (b) issue to the investors Company Warrants to purchase 1,000,000 shares of Company Common Stock for an exercise price of \$4.00 per share, and which Company Warrants, to the extent outstanding immediately prior to the Effective Time, shall be subject to the provisions of [Section 3.01\(c\)](#) as In-the-Money Company Warrants.

“[Business Data](#)” means all business information and data, including Personal Information (whether of employees, contractors, consultants, customers, consumers, or other persons and whether in electronic or any other form or medium) that is accessed, collected, used, processed, stored, shared, distributed, transferred, disclosed, destroyed, or disposed of by any of the Business Systems or otherwise in the course of the conduct of the business of the Company or any Company Subsidiaries.

“[Business Day](#)” means any day on which the principal offices of the SEC in Washington, D.C. are open to accept filings, or, in the case of determining a date when any payment is due, any day on which the electronic funds transfer systems, including for wire transfers, of commercial banks are not required or authorized to close in New York, NY, Delaware and California.

“[Business Systems](#)” means all Software, computer hardware (whether general or special purpose), electronic data processing, information, record keeping, communications, telecommunications, networks, interfaces, platforms, servers, peripherals, and computer systems, including any outsourced systems and processes, that are owned or used or held for use in the conduct of the Company Business.

“[CARES Act](#)” means the Coronavirus Aid, Relief, and Economic Security Act (Pub. L. 116-136) and any administrative or other guidance published with respect thereto by any Governmental Authority (including IRS Notices 2020-22 and 2020-65), or any other Law or executive order or executive memorandum (including the Memorandum on Deferring Payroll Tax Obligations in Light of the Ongoing COVID-19 Disaster, dated August 8, 2020) intended to address the consequences of COVID-19 (in each case, including any comparable provisions of state, local or non-U.S. Law and including any related or similar orders or declarations from any Governmental Authority).

“[Code](#)” means the United States Internal Revenue Code of 1986, as amended.

“[Company Business](#)” means the business of the Company and the Company Subsidiaries as currently conducted and currently proposed to be conducted as of the date hereof.

“[Company Closing Cash](#)” means the aggregate sum of the consolidated cash and cash equivalents of the Company and the Company Subsidiaries as of immediately prior to the Effective Time.

“[Company Closing Debt](#)” means all Company Debt outstanding as of immediately prior to the Effective Time, and which shall not include the Converting Notes.

“[Company Common Stock](#)” means the Company’s common stock, with a par value of \$0.001 per share.

“Company Convertible Notes” means: (a) the Convertible Promissory Note, dated June 23, 2021, issued by the Company with an aggregate principal amount of up to \$10,000,000 to the holder thereof, which the Company shall convert into shares of Company Common Stock in accordance with the terms of such Convertible Promissory Note immediately prior to the Effective Time (the “Converting Notes”); and (b) the Reformed Convertible Promissory Notes (2020 Series Convertible Promissory Notes Due July 1, 2025), issued by the Company with an aggregate principal amount of up to \$3,500,000 to the holders thereof (the “Surviving Notes”).

“Company Debt” means the following consolidated obligations and liabilities of the Company and the Company Subsidiaries: (a) all indebtedness for borrowed money or in respect of loans or advances of any kind or for the deferred purchase price of property; (b) the amount of all liabilities pursuant to all financial leases; (c) all liabilities evidenced by bonds, debentures, notes or similar instruments or debt securities, including the Company Convertible Notes; (d) all guarantees of the debt of other persons; (e) all liabilities in respect of bankers’ acceptances; and (f) all fees, accrued and unpaid interest, premiums or penalties (including prepayment penalties) or other obligations related to any of the foregoing.

“Company Equity Securities” means the Company Common Stock, the In-the-Money Company Warrants, the In-the-Money Company Warrants Shares and Company Convertible Notes Shares.

“Company Equity Securityholder” means the holder, as of immediately prior to the Effective Time, of any Company Equity Securities.

“Company Fully Diluted Capital Stock” means, without duplication, the sum of (a) the aggregate number of shares of Company Common Stock that are issued and outstanding as of immediately prior to the Effective Time (including shares issued upon the exercise of Company Options, the shares issued upon exercise of Company Warrants, and the shares issued pursuant to the conversion of the Company Convertible Notes (the “Company Convertible Notes Shares”), in each case immediately prior to the Effective Time, but excluding any shares to be cancelled pursuant to Section 3.01(a)(ii)), and (b) the aggregate number of In-the-Money Company Warrant Shares.

“Company IP” means, collectively, all Company-Owned IP and Company-Licensed IP.

“Company-Licensed IP” means all Intellectual Property owned or purported to be owned by a third party and licensed to the Company or to any Company Subsidiary, whether exclusively, non-exclusively, through a license, through a covenant, or on any other basis.

“Company Material Adverse Effect” means any event, circumstance, change, development, effect or occurrence (collectively “Effect”) that, individually or in the aggregate with all other Effects, (a) is or would reasonably be expected to be materially adverse to the business, condition (financial or otherwise), assets, liabilities or operations of the Company and the Company Subsidiaries taken as a whole or (b) prevents, materially delays or materially impedes the performance by the Company of its obligations under this Agreement or the consummation of the Merger or any of the other Transactions; provided, however, that none of the following shall be deemed to constitute, alone or in combination, or be taken into account in the determination of whether, there has been or will be a Company Material Adverse Effect: (i) any change or proposed change in or change in the interpretation of any Law (including any COVID-19 Measures) or GAAP after the date of this Agreement; (ii) events or conditions generally affecting the industries or geographic areas in which the Company and the Company Subsidiaries operate; (iii) any downturn in general economic conditions, including changes in the credit, debt, securities, financial or capital markets (including changes in interest or exchange rates, prices of any security or market index or commodity or any disruption of such markets); (iv) acts of war, sabotage, civil unrest, terrorism, epidemics, pandemics or disease outbreaks (including COVID-19), or any escalation or worsening of any such acts of war, sabotage, civil unrest, terrorism, epidemics, pandemics or disease outbreaks, or changes in global, national, regional, state or local political or social conditions; (v) any hurricane, tornado, flood, earthquake, natural disaster, or other acts of God, (vi) any actions taken or not taken by the Company or

the Company Subsidiaries as required by this Agreement or any Ancillary Agreement, (vii) any Effect attributable to the announcement or execution, pendency, negotiation or consummation of the Merger or any of the other Transactions (including the impact thereof on relationships with customers, suppliers, employees or Governmental Authorities), (viii) any failure to meet any projections, forecasts, guidance, estimates, milestones, budgets or financial or operating predictions of revenue, earnings, cash flow or cash position, provided that this clause (viii) shall not prevent a determination that any change, event, or occurrence underlying such failure has resulted in a Company Material Adverse Effect, (ix) any actions taken, or failures to take action, or such other changes or events, in each case, which GigCapital5 has requested or to which it has consented or which actions are contemplated by this Agreement or (x) any statements or items set forth in the Company Disclosure Schedule, except in the cases of clauses (i) through (iii), to the extent that the Company and the Company Subsidiaries, taken as a whole, are materially and disproportionately affected thereby as compared with other participants in the industries in which the Company and the Company Subsidiaries operate.

“Company Option Plan” means the QT Imaging, Inc. 2021 Stock Incentive Plan, as such may have been amended, supplemented or modified from time to time.

“Company Options” means all options to purchase shares of Company Common Stock that are outstanding as of immediately prior to the Effective Time, including such options granted under the Company Option Plan.

“Company-Owned IP” means all Intellectual Property owned or purported to be owned by the Company or any of the Company Subsidiaries and all Intellectual Property where applicable Law precludes an employee, consultant, contractor or other Person from assigning Intellectual Property to the Company where such employee, contractor, consultant or other Person grants to the Company, in lieu of such prohibited assignment, exclusive, irrevocable, transferrable and sublicensable licenses and usage rights to fully exploit, use and practice such non-assignable Intellectual Property.

“Company Products” means any and all products that are currently manufactured, distributed, sold, licensed, or otherwise offered or commercialized by the Company or any Company Subsidiary.

“Company Services” means all services, products and related software that are currently developed, delivered, provided, offered or commercialized by the Company or any Company Subsidiary, including, without limitation, broad-based medical imaging solutions for breast, infant body and orthopedics using FDA-cleared breast scanner with better sensitivity and specificity than mammography.

“Company Software” means Software that consists of Company-Owned IP.

“Company Transaction Expenses Cap” means an amount equal to \$4,000,000.

“Company Warrant” means a warrant to purchase Company Common Stock.

“Confidential Information” means all information constituting or relating to Intellectual Property, technology, product development, price, customer and supplier lists, pricing and marketing plans, policies and strategies, details of client and consultant contracts, operations methods, product development techniques, business acquisition plans or new personnel acquisition plans and all other confidential or proprietary information with respect to a party and its customers and vendors. Confidential Information includes any information, knowledge or data concerning the businesses and affairs of the Company, the Company Subsidiaries, or any Suppliers or customers of the Company or any Company Subsidiaries or GigCapital5 or its subsidiaries (as applicable) that is not already generally available to the public. Notwithstanding the foregoing, “Confidential Information” shall not include (a) issued Patents and published Patent applications or (b) information that is or becomes generally available to the public or general industry knowledge through no action or inaction by the Company.



“control” (including the terms “controlled by” and “under common control with”) means the possession, directly or indirectly, or as trustee or executor, of the power to direct or cause the direction of the management and policies of a person, whether through the ownership of voting securities, as trustee or executor, by contract or otherwise.

“Copyright License” means any license that requires, as a condition of use, modification or distribution of Software or other technology subject to such license, that such Software or other technology subject to such license, or other Software or other technology incorporated into, derived from, used or distributed with such Software or other technology subject to such license (a) in the case of Software, be made available or distributed in a form other than binary (e.g., source code form), (b) be licensed for the purpose of preparing derivative works, (c) be licensed under terms that allow the Company Products, other products or Software, or portions thereof or interfaces therefor to be reverse engineered, reverse assembled or disassembled (other than by operation of Law) or (d) be redistributable at no license fee. Copyright Licenses include GNU General Public License, the Affero General Public License, the GNU Lesser General Public License, the Mozilla Public License, the Common Development and Distribution License, the Eclipse Public License and all Creative Commons “sharealike” licenses.

“COVID-19” shall mean SARS-CoV-2 or COVID-19, and any evolutions or mutations thereof or related or associated epidemics, pandemic or disease outbreaks.

“COVID-19 Measures” means any quarantine, “shelter in place,” “stay at home,” workforce reduction, social distancing, shut down, closure, sequester, workplace safety or similar Law promulgated by any Governmental Authority, including the Centers for Disease Control and Prevention and the World Health Organization, in each case, in connection with or in response to COVID-19, including the CARES Act and Families First Act.

“Disabling Devices” means Software viruses, time bombs, logic bombs, trojan horses, trap doors, back doors, or other computer instructions, intentional devices or techniques that are designed to threaten, infect, assault, vandalize, defraud, disrupt, damage, disable, maliciously encumber, hack into, incapacitate, infiltrate or slow or shut down a computer system or any component of such computer system, including any such device affecting system security or compromising or disclosing user data in an unauthorized manner.

“Domain Names” means any and all Internet domain names and numerical addresses.

“Environmental Laws” means any United States federal, state or local or non-United States laws, including common law, relating to: (a) the Release of Hazardous Substances or materials containing Hazardous Substances; (b) the manufacture, handling, transport, use, treatment, storage, generation, packaging, registration, distribution, formulation, labelling, exposure to or disposal of Hazardous Substances or materials containing Hazardous Substances; or (c) pollution or protection of human health, safety, or the environment or natural resources; including, without limitation, the Comprehensive Environmental Response, Compensation, and Liability Act of 1980, as amended by the Superfund Amendments and Reauthorization Act of 1986, 42 U.S.C. §§ 9601 et seq.; the Solid Waste Disposal Act, as amended by the Resource Conservation and Recovery Act of 1976, as amended by the Hazardous and Solid Waste Amendments of 1984, 42 U.S.C. §§ 6901 et seq.; the Federal Water Pollution Control Act of 1972, as amended by the Clean Water Act of 1977, 33 U.S.C. §§ 1251 et seq.; the Toxic Substances Control Act of 1976, as amended, 15 U.S.C. §§ 2601 et seq.; the Emergency Planning and Community Right-to-Know Act of 1986, 42 U.S.C. §§ 11001 et seq.; the Clean Air Act of 1966, as amended by the Clean Air Act Amendments of 1990, 42 U.S.C. §§ 7401 et seq.; and the Occupational Safety and Health Act of 1970, as amended, 29 U.S.C. §§ 651 et seq. and their implementing regulations and any state analogs, each as amended from time to time.

“Exchange Ratio” means the quotient of (a) the Aggregate Closing Merger Consideration divided by (b) the Company Fully Diluted Capital Stock.

“FDA” means the United States Food and Drug Administration.

“Federal Health Care Program” means any “*federal health care program*” as defined in 42 U.S.C. § 1320a-7b(f), including Medicare, state Medicaid programs, state CHIP programs, TRICARE and similar or successor programs with or for the benefit of any Governmental Authority.

“Fraud” means an actual and intentional misrepresentation by a party of a representation or warranty expressly stated in Article IV of this Agreement; which satisfies each of the following conditions: (a) such representation or warranty was materially false or materially inaccurate at the time such representation or warranty was made; (b) the party making such representation or warranty had actual knowledge (and not imputed or constructive knowledge), without any duty of inquiry or investigation, that such representation or warranty was materially false or materially inaccurate when made; (c) such party had the specific intent to deceive another party and induce such other party to enter into this Agreement and (d) such other party reasonably relied on such false or inaccurate representation or warranty in entering into this Agreement. “Fraud” shall not include any cause of action under law or equity, including for fraud, based on constructive or imputed knowledge, negligence or recklessness and only the persons who committed Fraud shall be responsible for such Fraud and only to the party established to have suffered from such Fraud.

“GigCapital5 Certificate of Incorporation” means the Amended and Restated Certificate of Incorporation of GigCapital5 filed with the Secretary of the State of the State of Delaware on September 23, 2021, as such may have been amended, supplemented or modified from time to time.

“GigCapital5 Common Stock” means GigCapital5’s common stock, par value \$0.0001 per share before the Effective Time and QTI Holdings Common Stock on and after the Effective Time.

“GigCapital5 Material Adverse Effect” means any Effect that, individually or in the aggregate with all other Effects, (a) is or would reasonably be expected to be materially adverse to the business, condition (financial or otherwise) or results of operations of GigCapital5; or (b) would prevent, materially delay or materially impede the performance by GigCapital5 or Merger Sub of their respective obligations under this Agreement or the consummation of the Merger or any of the other Transactions; provided, however, that none of the following shall be deemed to constitute, alone or in combination, or be taken into account in the determination of whether, there has been or will be a GigCapital5 Material Adverse Effect: (i) any change or proposed change in or change in the interpretation of any Law (including any COVID-19 Measures) or GAAP after the date of this Agreement; (ii) events or conditions generally affecting the industries or geographic areas in which GigCapital5 operates; (iii) any downturn in general economic conditions, including changes in the credit, debt, securities, financial or capital markets (including changes in interest or exchange rates, prices of any security or market index or commodity or any disruption of such markets); (iv) acts of war, sabotage, civil unrest, terrorism, epidemics, pandemics or disease outbreaks (including COVID-19) or any escalation or worsening of any such acts of war, sabotage, civil unrest, terrorism, epidemics, pandemics or disease outbreaks, or changes in global, national, regional, state or local political or social conditions; (v) any hurricane, tornado, flood, earthquake, natural disaster, or other acts of God; (vi) any actions taken or not taken by GigCapital5 as required by this Agreement or any Ancillary Agreement; (vii) any Effect attributable to the announcement or execution, pendency, negotiation or consummation of the Merger or any of the other Transaction; or (viii) any actions taken, or failures to take action, or such other changes or events; in each case, which the Company has requested or to which it has consented or which actions are contemplated by this Agreement, except in the cases of clauses (i) through (iii), to the extent that GigCapital5 is materially and disproportionately affected thereby as compared with other participants in the industry in which GigCapital5 operates.

“GigCapital5 Organizational Documents” means the GigCapital5 Certificate of Incorporation, Bylaws, and the Trust Agreement, in each case as amended, modified or supplemented from time to time.

“GigCapital5 Transaction Expenses Cap” means an amount equal to \$7,000,000.

“GigCapital5 Units” means one share of GigCapital5 Common Stock and one GigCapital5 Warrant.

“GigCapital5 Warrants” means warrants to purchase shares of GigCapital5 Common Stock, with each warrant exercisable for one share of GigCapital5 Common Stock at an exercise price of \$11.50.

“Hazardous Substances” means: (a) any substances defined in, classified in or regulated under any Environmental Law, including the following United States federal statutes and their state counterparts, as each may be amended from time to time, and all regulations thereunder: the Hazardous Materials Transportation Act, the Resource Conservation and Recovery Act, the Comprehensive Environmental Response, Compensation and Liability Act, the Clean Water Act, the Safe Drinking Water Act, the Atomic Energy Act, the Federal Insecticide, Fungicide, and Rodenticide Act and the Clean Air Act; (b) petroleum and petroleum products, including crude oil and any fractions thereof; (c) diesel fuel, natural gas, synthetic gas, and any mixtures thereof; (d) polychlorinated biphenyls, asbestos, per- and polyfluoroalkyl substances, radioactive materials and radon; and (e) any substance, pollutant, contaminant, material or waste in any amount or concentration which are regulated by any Governmental Authority or for which liability may be imposed pursuant to any Environmental Law.

“Health Care Laws” means all applicable Laws and orders relating to health care providers’ and health care facilities’ participation in Federal Health Care Programs, the practice of medicine, institutional and professional licensure, diagnostic testing, unprofessional conduct, fee-splitting, referrals, patient brokering, kickbacks, billing and submission of false or fraudulent claims, claims processing, quality, safety, medical necessity, medical privacy and security, patient confidentiality and informed consent, the hiring of employees or acquisition of services or supplies from Persons excluded from participation in Federal Health Care Programs, standards of care, quality assurance, risk management, advertising or marketing of health care services, including Medicare, Medicaid, CHIP, the TRICARE law (8 U.S.C. § 1071, et seq.), the False Claims Act (31 U.S.C. § 3729, et seq.), the Civil Monetary Penalties Law (42 U.S.C. § 1320a-7a), federal and state anti-kickback statutes (including 42 U.S.C. § 1320a 7b), federal and state referral laws (including 42 U.S.C. §1395nn), criminal false claims statutes (e.g. 18 U.S.C. §§ 287 and 1001), the Program Fraud Civil Remedies Act of 1986 (31 U.S.C. §3801, et seq.), the Beneficiary Inducement Statute (42 U.S.C. §1320a-7a(a)(5)), the Emergency Medical Treatment and Active Labor Act (42 U.S.C. § 1395dd), the Clinical Laboratory Improvement Act (42 U.S.C. § 263a, et seq.), the Medicare Prescription Drug, Improvement and Modernization Act of 2003 (P.L. 108-173, 117 Stat. 2066), the Food, Drug and Cosmetic Act of 1938 (21 U.S.C. § 301, et seq.), the Prescription Drug Marketing Act of 1987 (P.L. 100-293, 102 Stat. 95), the Controlled Substances Act (21 U.S.C. § 801, et seq.), the Patient Protection and Affordable Care Act of 2010, the Physician Payment Sunshine Act (42 USC §1320a-7h), the Physician Ownership and Referral Act of 1993, the California Business and Professions Code, the California Welfare and Institutions Code, the Moscone-Knox Professional Corporation Act and the Health Insurance Portability and Accountability Act of 1996 (“HIPAA”) and the rules and regulations promulgated under the foregoing statutes.

“HSR Act” means the Hart-Scott-Rodino Antitrust Improvements Act of 1976, as amended.

“In-the-Money Company Warrant Shares” means the maximum number of shares of Company Common Stock issuable upon full exercise, exchange or conversion of all In-the-Money Company Warrants outstanding as of immediately prior to the Effective Time and that will become an Assumed Warrant.

“In-the-Money Company Warrants” means (a) the Pre-Signing In-the-Money Company Warrants and (b) any additional Company Warrants issued pursuant to the Bridge Financing.

“Inbound IP Licenses” means all contracts pursuant to which the Company or any Company Subsidiary has received a license or sublicense, or has otherwise been granted rights in, to, or under any Intellectual Property from any person, or otherwise received from any person any immunity, authorization, release, covenant not to sue or other right with respect to any such Intellectual Property, excluding (i) non-disclosure agreements entered into the ordinary course of business, (ii) incidental Trademark and feedback licenses, (iii) contracts for Off-the-Shelf Software, and (iv) licenses for Open Source Materials.

“Intellectual Property” means: all intellectual property rights, anywhere in the world, whether statutory, common law or otherwise, including (a) Patents, (b) copyrights and all other rights with respect to works of authorship, (c) all other rights with respect to Software, including registrations thereof and applications therefor, (d) registered and unregistered design rights and registrations thereof and applications therefor, (e) rights with respect to Trademarks, and all registrations thereof and applications therefor, (f) rights with respect to Domain Names, including registrations thereof and applications therefor, (g) rights with respect to trade secrets or Confidential Information, including rights to limit the use or disclosure thereof by any Person, (h) rights with respect to databases, including registrations thereof and applications therefor, (i) publicity and privacy rights, including all rights with respect to use of a Person’s name, signature, likeness, image, photograph, voice, identity, personality, and biographical and personal information and materials, and (j) any rights equivalent or similar to any of the foregoing.

“International Trade Laws” means (i) all U.S. import and export Laws (including those Laws administered by the U.S. Departments of Commerce (Bureau of Industry and Security) codified at 15 C.F.R., Parts 700-774; Homeland Security (Customs and Border Protection) codified at 19 C.F.R., Parts 1-192; State (Directorate of Defense Trade Controls) codified at 22 C.F.R., Parts 103, 120-130; and the Treasury (Office of Foreign Assets Control) codified at 31 C.F.R., Parts 500-598) and (ii) all comparable applicable Laws outside the United States.

“IRS” means the United States Internal Revenue Service.

“Key Company Stockholders” means the persons and entities listed on Schedule 7.03.

“knowledge” or “to the knowledge” of a person shall mean in the case of the Company, the actual knowledge of the persons listed on Schedule 1.01 after reasonable inquiry, and in the case of GigCapital5, the actual knowledge of Drs. Avi Katz and Raluca Dinu after reasonable inquiry.

“Law” means any applicable federal, state, local, municipal, foreign, international, multinational or other constitution, statute, law, rule, regulation, ordinance, code, principle of common law or treaty, including, without limitation, any Health Care Laws.

“Leased Real Property” means the real property leased by the Company or Company Subsidiaries as tenant, together with, to the extent leased by the Company or Company Subsidiaries, all buildings and other structures, facilities or improvements located thereon and all easements, licenses, rights and appurtenances of the Company or Company Subsidiaries relating to the foregoing.

“Lien” means any lien, security interest, mortgage, pledge, adverse claim or other encumbrance of any kind that secures the payment or performance of an obligation (other than those created under applicable securities laws).

“Merger Consideration Earnout Share Pool” means 9,000,000 shares of GigCapital5 Common Stock, as such shares may be adjusted for any stock split, reverse stock split, recapitalization, reclassification, reorganization, exchange, subdivision or combination.

“Merger Consideration Earnout Shares” means shares of GigCapital5 Common Stock issuable to the Company Equity Securityholders after the Closing pursuant to the terms of Section 3.07 hereof.

“Merger Sub Organizational Documents” means the certificate of incorporation and Bylaws of Merger Sub, as amended, modified or supplemented from time to time.

“Off-the-Shelf Software” means Software, software-as-a-service, or other technology that is licensed or otherwise made available on a non-exclusive basis under a “shrink-wrap” or “click-through” contract or other contract containing standard terms and Software or software-as-a-service for which the Company and Company Subsidiaries have paid a one-time license fee of less than \$10,000 per license.

“Open Source License” means any license meeting the Open Source Definition (as promulgated by the Open Source Initiative), the Free Software Definition (as promulgated by the Free Software Foundation), any Creative Commons License, or any substantially similar license, including any license approved by the Open Source Initiative. For the avoidance of doubt, Open Source Licenses include Copyleft Licenses.

“Open Source Materials” means any Software or other Intellectual Property subject to an Open Source License.

“order” means, if the context permits, any applicable order, injunction, judgment, decree, ruling, assessment or arbitration award of any Governmental Authority or arbitrator.

“ordinary course of business” means, with respect to any Person, the ordinary course of business of such Person consistent with past custom and practice (including with respect to quantity and frequency).

“Outbound IP Licenses” means contracts pursuant to which the Company or any Company Subsidiary has licensed or sublicensed or otherwise granted rights in, to, or under any material Company IP to any person, or granted to any person any immunity, authorization, release, covenant not to sue or other right with respect to any Company IP, excluding (i) non-disclosure agreements entered into the ordinary course of business, (ii) incidental feedback licenses, and (iii) non-exclusive licenses granted to the Company’s service providers or vendors solely for the purpose of providing services to the Company.

“Owned Real Property” means the land owned by the Company or any of the Company Subsidiaries (collectively, the “Land”), together with all buildings and other structures, facilities, and other improvements located thereon (collectively, the “Improvements”); all right, title and interest of the Company or any Company Subsidiary, as applicable, if any, in and to any and all appurtenances, strips or gores, roads, easements, streets, alleys, drainage facilities and rights-of-way bounding any of the Land; all utility capacity, utilities, water rights, licenses, permits, entitlements, and bonds, if any, and all other rights and benefits attributable to the Land; and all rights of ingress and egress thereto; all transferable consents, authorizations, variances or waivers, licenses, permits and approvals from any Governmental Authority in connection with the Land or the Improvements held by or granted to the Company or any Company Subsidiary, as applicable, any of their respective predecessors in title, and/or the agents thereof with respect to the Land or the Improvements; all right, title and interest of the Company or any Company Subsidiary, as applicable, in and to all site plans, surveys, soil and substratus studies, and engineering and architectural drawings, plans and specifications, in the possession or control of the Company or any Company Subsidiary, as applicable, relating to the Land or Improvements; all equipment and other personal property owned by the Company or any Company Subsidiary, as applicable, located on and/or exclusively used in connection with the operation of the Land or Improvements; and all written service and maintenance contracts and other written contracts, if any, relating to the Land or Improvements.

“Patents” means any domestic or foreign patents, utility models and applications, drafts and disclosures relating thereto (and any patents or utility models that issue as a result of such applications, drafts and disclosures) and any reissues, divisions, divisionals, continuations, continuations-in-part, provisionals, renewals, extensions, substitutions, reexaminations or invention registrations related to such patents, utility models and applications.

“PCAOB” means the Public Company Accounting Oversight Board and any division or subdivision thereof.

“Permitted Liens” means: (a) such imperfections of title, easements, encumbrances, Liens or restrictions that do not materially impair the current use of the Company’s or any Company Subsidiary’s assets that are subject thereto; (b) materialmen’s, mechanics’, carriers’, workmen’s, warehousemen’s, repairmen’s, landlord’s and other similar Liens arising in the ordinary course of business, or deposits to obtain the release of such Liens; (c) Liens for Taxes not yet due and payable, or being contested in good faith; (d) zoning, entitlement,

conservation restriction and other land use and environmental regulations promulgated by Governmental Authorities; (e) non-exclusive licenses, sublicenses or other rights to Intellectual Property owned by or licensed to the Company or the Company Subsidiaries granted to any licensee in the ordinary course of business; (f) non-monetary Liens, encumbrances and restrictions on real property (including easements, covenants, rights of way and similar restrictions of record) that do not materially interfere with the present uses of such real property; (g) Liens identified in the Financial Statements; and (h) Liens on leases, subleases, easements, licenses, rights of use, rights to access and rights of way arising from the provisions of such agreements or benefiting or created by any superior estate, right or interest.

“person” or “Person” means an individual, corporation, partnership, limited partnership, limited liability company, syndicate, person (including, without limitation, a “person” as defined in Section 13(d)(3) of the Exchange Act), trust, association or entity or government, political subdivision, agency or instrumentality of a government.

“Personal Information” means all data relating to one or more individual(s), including patients and employees, that is personally identifying (i.e., data that identifies an individual or, in combination with any other information or data available to the Company, is capable of identifying an individual) or capable of identifying a specific device or non-personally identifying, including, without limitation, aggregate or de-identified data and data collected automatically, including data collected through a mobile or other electronic device. This definition includes any “personally identifiable information,” “PII,” “personal information,” “protected health information” and “personal data” as defined by Privacy Laws.

“Processing” means any operation performed on Personal Information such as collection, recording, organization, sale, structuring, storage, adaptation or alteration, retrieval, consultation, use, access, security, disclosure, transfer, dissemination or otherwise making available, alignment or combination, restriction, erasure or destruction.

“Products” mean any products or services, developed, manufactured, performed, out-licensed, sold, distributed other otherwise made available by or on behalf of the Company or any Company Subsidiary, from which the Company or any Company Subsidiary has derived previously, is currently deriving or is scheduled to derive, revenue from the sale or provision thereof.

“QTI Holdings Organizational Documents” means the Second Amended and Restated Certificate of Incorporation of QTI Holdings in the form set forth on Exhibit E, and the initial Bylaws of QTI Holdings with effect from and after the Effective Time.

“Redemption Rights” means the redemption rights provided for in Section 9.2 of Article IX of the GigCapital5 Certificate of Incorporation.

“Registered Company IP” means Company-Owned IP for which registrations have been obtained or applications for registration have been filed with any Governmental Authority or Domain Name.

“Release” means any actual or threatened release, spilling, leaking, pumping, pouring, emitting, emptying, discharging, injecting, escaping, leaching, dumping, abandonment, disposing, or migrating through, in, on, under, or into the environment (including, without limitation, indoor or outdoor ambient air, surface water, groundwater, land surface or subsurface strata or within any building, structure, facility or fixture).

“Requisite Approval” means the affirmative vote of the holders of at least (i) a majority of the outstanding shares of the Company Common Stock, voting together as a single class.

“R&W Insurance Policy” means the buyer-side representation and warranty insurance policy obtained by GigCapital5 and bound by the R&W Insurance Provider on the Closing Date in relation to the transactions contemplated by this Agreement.

“R&W Insurance Provider” means the provider(s) of the R&W Insurance Policy.

“Software” means (a) computer programs, firmware, software (whether in source code, object code or other form), models, algorithms, methodologies and implementations thereof; (b) development tools, descriptions and flow charts; (c) data, metadata, databases and compilations of data, whether machine readable or otherwise; and (d) documentation, product user manuals, and training materials used to design, plan, organize, maintain, support or develop any of the foregoing, irrespective of the media on which it is recorded.

“Subsidiary” or “Subsidiaries” of the Company, the Surviving Corporation, GigCapital5 or any other person means an affiliate controlled by such person, directly or indirectly, through one or more intermediaries.

“Supplier” means any person that supplies inventory or other materials or personal property, components, or other goods or services that are utilized in or comprise the Products of the Company or any of the Company Subsidiaries.

“Tax” or “Taxes” means all federal, state, local, foreign, or other income, profits, franchise, gross receipts, environmental, capital stock, severances, stamp, payroll, sales, employment, unemployment, escheat or unclaimed property, disability, use, property, withholding, excise, production, value added, social insurance, customs, duties, tariffs, occupancy and other fees, assessments or governmental charges of any nature whatsoever, whether computed on a separate or combined, unitary, or consolidated basis or in any other manner, together with all interest, deficiencies, penalties and additions imposed with respect to such amounts and any interest in respect of such penalties and additions, whether disputed or not.

“Tax Returns” means all returns, statements, claims for refund, and reports (including customs entries and summaries, elections, declarations, disclosures, schedules, estimates and information returns, as well as attachments thereto and amendments thereof) supplied or required to be supplied to a Tax authority relating to Taxes.

“Trade Secrets” means (i) all know-how, confidential, proprietary and non-public information, however documented and whether or not documented and (ii) all trade secrets within the meaning of Applicable Law. The term “Trade Secrets” includes concepts, ideas, knowledge, rights in research and development, financial, marketing and business data, pricing and cost information, plans (including business and marketing plans), algorithms, formulae, inventions, processes, techniques, technical data, designs, drawings (including engineering and auto-cad drawings), specifications, databases, blue prints, and customer and supplier lists and information, in each case that has or derives economic value, actual or potential, as a result of being a secret and not known to the public, whether patentable or not and whether or not reduced to practice.

“Trademarks” means unregistered and registered trademarks and service marks, trademark and service mark applications, common law trademarks and service marks, trade dress and logos, trade names, business names, corporate names, product names and other source or business identifiers and the goodwill associated with any of the foregoing and any renewals and extensions of any of the foregoing.

“Transaction Documents” means this Agreement, including all Schedules and Exhibits hereto, the Company Disclosure Schedule, the Ancillary Agreements, and all other agreements, certificates and instruments executed and delivered by GigCapital5, Merger Sub or the Company in connection with the Transactions and specifically contemplated by this Agreement.

“Transactions” means the transactions contemplated by this Agreement and the Transaction Documents.

“Treasury Regulations” means the United States Treasury regulations issued pursuant to the Code.

“VWAP” means, for any security as of any date(s), the dollar volume-weighted average price for such security on the principal securities exchange or securities market on which such security is then traded during the period beginning at 9:30:01 a.m., New York time, and ending at 4:00:00 p.m., New York time, as reported by Bloomberg through its “HP” function (set to weighted average) or, if the foregoing does not apply, the dollar volume-weighted average price of such security in the over-the-counter market on the electronic bulletin board for such security during the period beginning at 9:30:01 a.m., New York time, and ending at 4:00:00 p.m., New York time, as reported by Bloomberg, or, if no dollar volume-weighted average price is reported for such security by Bloomberg for such hours, the average of the highest closing bid price and the lowest closing ask price of any of the market makers for such security as reported by OTC Markets Group Inc. If the VWAP cannot be calculated for such security on such date(s) on any of the foregoing bases, the VWAP of such security on such date(s) shall be the fair market value per share on such date(s) as reasonably determined in good faith by a majority of the disinterested independent directors of the board of directors (or equivalent governing body) of QTI Holdings at such time.

**SECTION 1.02 Further Definitions.** The following terms have the meaning set forth in the Sections set forth below:

<b>Defined Term</b>	<b>Location of Definition</b>
2023 Earnout Shares	§ 3.07(c)(i)
2024 Earnout Shares	§ 3.07(c)(ii)
2025 Earnout Shares	§ 3.07(c)(iii)
2023 Form 10-K	§ 3.07(c)(i)
2024 Form 10-K	§ 3.07(c)(ii)
2025 Form 10-K	§ 3.07(c)(ii)
Action	§ 4.09
Agreement	Preamble
Alternative Transaction	§ 7.05(a)
Antitrust Laws	§ 7.13(a)
Assumed Warrant	§ 3.01(c)
Awards	§ 7.06
Blue Sky Laws	§ 4.05(b)
Business Combination Proposal	§ 7.05(b)
Certificate of Merger	§ 2.02(a)
Certificates	§ 3.02(b)
Claims	§ 6.03
Closing	§ 2.02(b)
Closing Date	§ 2.02(b)
Company	Preamble
Company Board	Recitals
Company Directors	§ 2.05(c)
Company Disclosure Schedule	Article IV
Company D&O Tail Insurance	§ 7.07(b)
Company Permits	§ 4.06
Company Preferred Stock	§ 4.03(a)
Company Share Awards	§ 4.03(a)
Company Stockholder Approval	§ 4.19
Company Subsidiary	§ 4.01(a)
Company Transaction Expenses	§ 3.04(a)
Confidentiality Agreement	§ 7.04(b)
Contingent Worker	§ 4.12(h)
Contribution	§ 4.14(e)
DGCL	Recitals



<b>Defined Term</b>	<b>Location of Definition</b>
Effect	§ 1.01
Effective Time	§ 2.02(a)
Environmental Permit	§ 4.15
Equity Plan	§ 7.06
ERISA	§ 4.11(a)
ERISA Affiliate	§ 4.11(c)
Estimated Closing Statement	§ 3.06(a)
Exchange Act	§ 4.22
Exchange Agent	§ 3.02(a)
Exchange Fund	§ 3.02(a)
Exchanges	§ 2.05(b)
Financial Statements	§ 4.07(b)
GAAP	§ 4.07(a)
GigCapital5	Preamble
GigCapital5 Board	Recitals
GigCapital5 Closing Statement	§ 3.06(b)
GigCapital5 Preferred Stock	§ 5.03(a)
GigCapital5 Proposals	§ 7.01(a)
GigCapital5 SEC Reports	§ 5.07(a)
GigCapital5 Stockholders' Meeting	§ 7.01(a)
GigCapital5 Transaction Expenses	§ 3.04(b)
Governmental Authority	§ 4.05(b)
Health Plan	§ 4.11(k)
HITECH	§ 4.14(i)
Improvements	§ 1.01
Initial PCAOB Financial Statements	§ 7.14
Initial Post-Closing QTI Holdings Directors	§ 2.05(c)
Intended Tax Treatment	Recitals
Land	§ 1.01
Law(s)	§ 4.05(a)
Lease	§ 4.12(b)
Lease Documents	§ 4.12(b)
Letter of Transmittal	§ 3.02(b)
Lock-Up Agreement	Recitals
Material Contracts	§ 4.16(a)
Merger	Recitals
Merger Sub	Preamble
Merger Sub Board	Recitals
Merger Sub Common Stock	§ 5.03(b)
Nasdaq	§ 2.05(b)
NYSE	§ 2.05(b)
OFAC	§ 4.17(b)
Outside Date	§ 9.01(b)
Paid Company Transaction Expenses	§ 3.04(a)
Paid GigCapital5 Transaction Expenses	§ 3.04(b)
PCAOB Financial Statements	§ 7.14
Per Share Merger Consideration	§ 3.01(a)(i)
Plans	§ 4.10(a)
PPACA	§ 4.10(k)
Pre-Signing In-the-Money Company Warrants	§ 4.03(e)
Prior Financial Statements	§ 4.07(a)

Defined Term	Location of Definition
Privacy Requirements	§ 4.14(i)
Property	§ 4.14(k)
Pro Rata Share	§ 3.07(e)
Proxy Statement	§ 7.01(a)
Referral Recipient	§ 4.24(e)
QTI Holdings	Recitals
QTI Holdings Board	§ 2.05(a)
QTI Independent Directors	§ 2.05(b)
Referral Source	§ 4.24(e)
Registration Rights Agreement	Recitals
Registration Statement	§ 7.01(a)
Release Notice	§ 3.07(b)
Remedies Exceptions	§ 4.04
Representatives	§ 7.04(a)
SEC	§ 5.07(a)
Securities Act	§ 5.07(a)
Security Incident	§ 4.14(m)
Sponsor	Recitals
Sponsor Directors	§ 2.05(b)
Sponsor Support Agreement	Recitals
Standards Organizations	§ 4.14(s)
Stockholder Support Agreement	Recitals
Surviving Corporation	§ 2.01
Tail Policies	§ 7.07(e)
Terminating Company Breach	§ 9.01(f)
Terminating GigCapital5 Breach	§ 9.01(g)
Top Customer	4.14(z)
Top Supplier	4.14(z)
Transfer Agent Cancellation	§ 3.02(b)
Trust Account	§ 5.17
Trust Agreement	§ 5.17
Trust Fund	§ 5.17
Trustee	§ 5.17
Unpaid Company Transaction Expenses	§ 3.04(a)
Unpaid GigCapital5 Transaction Expenses	§ 3.04(b)
WARN Act	§ 4.12(c)
Written Consent	§ 7.03

**SECTION 1.03 Construction.**

(a) Unless the context of this Agreement otherwise requires, (i) words of any gender include each other gender, (ii) words using the singular or plural number also include the plural or singular number, respectively, (iii) the terms “hereof,” “herein,” “hereby,” “hereto” and derivative or similar words refer to this entire Agreement, (iv) the terms “Article,” “Section,” “Schedule” and “Exhibit” refer to the specified Article, Section, Schedule or Exhibit of or to this Agreement, (v) the word “including” means “including without limitation,” (vi) the word “or” shall be disjunctive but not exclusive, (vii) references to agreements and other documents shall be deemed to include all subsequent amendments and other modifications thereto, and (viii) references to statutes shall include all regulations promulgated thereunder and references to statutes or regulations shall be construed as including all statutory and regulatory provisions consolidating, amending or replacing the statute or regulation.

(b) The language used in this Agreement shall be deemed to be the language chosen by the parties to express their mutual intent and no rule of strict construction shall be applied against any party.

(c) Whenever this Agreement refers to a number of days, such number shall refer to calendar days unless Business Days are specified. If any action is to be taken or given on or by a particular calendar day, and such calendar day is not a Business Day, then such action may be deferred until the next Business Day.

(d) All accounting terms used herein and not expressly defined herein shall have the meanings given to them under GAAP.

## ARTICLE II. AGREEMENT AND PLAN OF MERGER

**SECTION 2.01 The Merger.** Upon the terms and subject to the conditions set forth in Article VIII, and in accordance with the DGCL, at the Effective Time, Merger Sub shall be merged with and into the Company. As a result of the Merger, the separate corporate existence of Merger Sub shall cease and the Company shall continue as the surviving corporation of the Merger (the "Surviving Corporation") and as a wholly-owned, privately-held subsidiary of GigCapital5 retaining the name QT Imaging, Inc. For the sake of clarity, all references to the Company for periods after the Effective Time shall include the term "Surviving Corporation."

### **SECTION 2.02 Effective Time; Closing.**

(a) As promptly as practicable, but in no event later than three (3) Business Days, after the satisfaction or, if permissible, waiver of the conditions set forth in Article VIII (other than those conditions that by their nature are to be satisfied at the Closing, it being understood that the occurrence of the Closing shall remain subject to the satisfaction or, if permissible, waiver of such conditions at the Closing), the parties hereto shall cause the Merger to be consummated by filing a certificate of merger (the "Certificate of Merger") with the Secretary of State of the State of Delaware, in such form as is required by, and executed in accordance with, the relevant provisions of the DGCL and mutually agreed by the parties (the date and time of the filing of such Certificate of Merger (or such later time as may be agreed by each of the parties hereto and specified in such Certificate of Merger) being the "Effective Time").

(b) Immediately prior to such filing of a Certificate of Merger in accordance with Section 2.02(a), a closing (the "Closing") shall be held remotely by exchanging the closing deliverables and signatures *via* email, for the purpose of confirming the satisfaction or waiver, as the case may be, of the conditions set forth in Article VIII. The date on which the Closing shall occur is referred to herein as the "Closing Date."

**SECTION 2.03 Effect of the Merger.** At the Effective Time, the effect of the Merger shall be as provided in the applicable provisions of the DGCL. Without limiting the generality of the foregoing, and subject thereto, at the Effective Time, all the property, rights, privileges, immunities, powers, franchises, licenses and authority of the Company and Merger Sub shall vest in the Surviving Corporation, and all debts, liabilities, obligations, restrictions, disabilities and duties of each of the Company and Merger Sub shall become the debts, liabilities, obligations, restrictions, disabilities and duties of the Surviving Corporation.

### **SECTION 2.04 Certificate of Incorporation; Bylaws.**

(a) At the Effective Time, by virtue of filing of the Certificate of Merger pursuant to the provisions of Section 2.02(a), the certificate of incorporation of the Surviving Corporation shall contain the provisions set forth on Exhibit E.

(b) At the Effective Time, the bylaws of Merger Sub, as in effect immediately prior to the Effective Time, shall be the bylaws of the Surviving Corporation, except that references therein to Merger Sub shall be treated as references to the Surviving Corporation, until thereafter amended as provided by law, the certificate of incorporation of the Surviving Corporation and such bylaws, as applicable.

(c) At the Closing, GigCapital5 shall amend and restate, effective as of the Effective Time, the GigCapital5 Certificate of Incorporation to be as set forth on Exhibit E, which shall among other things result in GigCapital5 being renamed as QT Imaging Holdings, Inc.

#### **SECTION 2.05 Directors and Officers.**

(a) Each of the parties hereto shall take all such action within its power as may be necessary or appropriate, including by causing certain directors of GigCapital5 to resign, such that, effective as of the Closing, (i) the “QTI Holdings Board” shall consist of seven (7) directors; (ii) the initial members of the QTI Holdings Board are the individuals determined in accordance with among other areas, the four key areas outlined in the signed letter of intent, Section 2.05(b), Section 2.05(c), and Section 2.05(d), as applicable; and (iii) the initial members of the compensation committee, audit committee and nominating and corporate governance committee of the QTI Holdings Board are the individuals determined in accordance with Section 2.05(d). In addition, the initial directors and officers of the Surviving Corporation shall be mutually agreed by GigCapital5 and the Company to be effective immediately after the Closing.

(b) Three (3) named individuals as set forth under the heading “Initial Post-Closing QTI Holdings Directors” and the subheading “Sponsor Directors” on Schedule 2.05 shall serve as Class I or Class III Directors (as each such term is defined in the QTI Holdings Organizational Documents following the Effective Time), as specified on Schedule 2.05, on the QTI Holdings Board effective as of the Closing (the “Sponsor Directors”). Each of such Sponsor Directors are qualified to serve as “independent directors” under the listing rules and regulations of The Nasdaq Stock Market LLC (“Nasdaq”), the New York Stock Exchange (the “NYSE”) or NYSE American (the “NYSE American,” and together with Nasdaq and NYSE, the “Exchanges”), applicable to service on committees of the QTI Holdings Board (“QTI Holdings Independent Directors”). GigCapital5 may, with the prior written consent of the Company (such consent not to be unreasonably withheld, conditioned or delayed), replace any such individual on the QTI Holdings Board with any other individual prior to the filing of the Registration Statement and Proxy Statement with the SEC by amending such list to include such replacement individual, provided, that such replacement individuals meet all the requirements of this Agreement, including being qualified to serve as QTI Independent Directors under the listing rules and regulations of the Exchanges.

(c) Three (3) named individuals and one (1) individual to be identified prior to the initial filing of the Registration Statement as set forth under the heading “Initial Post-Closing QTI Holdings Directors” and the subheading “Company Directors” on Schedule 2.05 shall serve as Class I, Class II or Class III Directors, as specified on Schedule 2.05, on the QTI Holdings Board effective as of the Closing (the “Company Directors” and, collectively with the Sponsor Directors, the “Initial Post-Closing QTI Holdings Directors”). At least one (1) of the Company Directors shall be qualified to serve as a QTI Holdings Independent Director under the listing rules and regulations of the Exchanges. The Company Director to be identified prior to the initial filing of the Registration Statement shall be subject to the written approval of GigCapital5, not to be unreasonably withheld, conditioned or delayed. The Company may, with the prior written consent of GigCapital5 (such consent not to be unreasonably withheld, conditioned or delayed), replace any such individual with any other individual prior to the filing of the Registration Statement and Proxy Statement with the SEC by amending such list to include such replacement individual, provided, that such replacement individuals meet all the requirements of this Agreement and at least one (1) of the individuals designated to the QTI Holdings Board pursuant to this Section 2.05(c) must be qualified to serve as a QTI Holdings Independent Director under the listing rules and regulations of the Exchanges. If for any individual who has been nominated to serve as a QTI Holdings Independent Director, such individual is not so qualified, then GigCapital5 shall omit from its proxy materials any such nominee, and any such nomination shall be disregarded and no vote on any such nominee will occur, notwithstanding that proxies in respect of such vote may have been received by GigCapital5.

(d) The individual with “Chairman of the QTI Holdings Board” set forth opposite his or her name of Schedule 2.05 shall serve as the Chairman of the QTI Holdings Board effective as of the Closing. Each of

the individuals with “Compensation Committee,” “Audit Committee,” and/or “Nominating and Corporate Governance Committee” set forth opposite his or her name on Schedule 2.05 shall serve as a member of the Compensation Committee, Audit Committee and Nominating and Corporate Governance Committee of the QTI Holdings Board, respectively, effective as of the Closing. Notwithstanding the foregoing, each of such individuals must be QTI Holdings Independent Directors and must meet the rules and regulations of the Exchanges regarding committee membership, and if the requirement set forth in this sentence is not met, GigCapital5 shall omit from its proxy materials any such nominee for service on such committee of the QTI Holdings Board.

### ARTICLE III. EFFECTS OF THE MERGER

#### SECTION 3.01 Conversion of Securities.

(a) At the Effective Time, by virtue of the Merger and without any action on the part of GigCapital5, Merger Sub, the Company or the holders of any of the following securities or rights:

(i) each share of Company Common Stock issued and outstanding immediately prior to the Effective Time (including shares issued upon the exercise or conversion of Company Options, Company Warrants and Company Convertible Notes, in each case prior to the Effective Time, but excluding any shares to be cancelled pursuant to Section 3.01(a)(ii)) shall be canceled and converted into (A) the right to receive a number of shares of GigCapital5 Common Stock equal to the Exchange Ratio (the “Per Share Merger Consideration”) and (B) the contingent right to receive a portion of the Merger Consideration Earnout Shares, if, as and when payable in accordance with the provisions of Section 3.07;

(ii) each share of Company Common Stock held in the treasury of the Company shall be canceled without any conversion thereof and no payment or distribution shall be made with respect thereto;

(iii) each share of Merger Sub Common Stock issued and outstanding immediately prior to the Effective Time shall be converted into and exchanged for one validly issued, fully paid and nonassessable share of common stock, par value \$0.0001 per share, of the Surviving Corporation; and

(b) Prior to the Effective Time, the Company shall in a manner acceptable to GigCapital5 take such actions as are necessary to terminate each Company Option that is outstanding immediately prior to the Effective Time, whether vested or unvested, including by payment or in accordance with Section 16(c)(ii) of the Company Option Plan by providing fifteen (15) day notice to holders of the Company Options that if the business combination is consummated, based on the anticipated value of the Company Options, the Company Options shall be terminated without any conversion thereof and no payment or distribution shall be made, and the holder thereof shall cease to have any rights, with respect thereto. At or prior to the Effective Time, the parties and their boards, as applicable, shall adopt any resolutions and take any actions that are necessary to effectuate the treatment of the Company Options pursuant to the provisions of this Section 3.01(b).

(c) Effective as of the Effective Time, each outstanding In-the-Money Company Warrant that is not exercised and exchanged prior to the Effective Time shall automatically, without any action on the part of the holder thereof, in accordance with the provisions thereof (for the avoidance of doubt, as may be amended following the date of this Agreement with the written approval of GigCapital5), be converted into a warrant to acquire a number of shares of GigCapital5 Common Stock at an adjusted exercise price per share, in each case, as determined under this Section 3.01(c) (each such resulting warrant, an “Assumed Warrant”). Each Assumed Warrant shall be subject to the same terms and conditions as were applicable to such corresponding In-the-Money Company Warrant immediately prior to the Effective Time (including applicable vesting conditions), except to the extent such terms or conditions are rendered inoperative by the

Transactions. Accordingly, effective as of the Effective Time: (A) each such Assumed Warrant shall be exercisable solely for shares of GigCapital5 Common Stock; (B) the number of shares of GigCapital5 Common Stock subject to each Assumed Warrant shall be determined by multiplying the number of shares of Company Common Stock subject to such In-the-Money Company Warrant, as in effect immediately prior to the Effective Time, by the Per Share Merger Consideration, and rounding the resulting number down to the nearest whole number of shares of GigCapital5 Common Stock; (C) the per share exercise price for the GigCapital5 Common Stock issuable upon exercise of each Assumed Warrant shall be determined by dividing the per share exercise price for the shares of Company Common Stock subject to the In-the-Money Company Warrant, as in effect immediately prior to the Effective Time, by the Per Share Merger Consideration, and rounding the resulting exercise price up to the nearest whole cent; and (D) the holder of each In-the-Money Company Warrant outstanding as of immediately prior to the Effective Time shall be entitled to the contingent right to receive a portion of the Merger Consideration Earnout Shares, if, as and when payable in accordance with the provisions of Section 3.07. Effective as of the Effective Time, each Company Warrant (other than any In-the-Money Company Warrant) that is outstanding immediately prior to the Effective Time, whether vested or unvested, shall, in accordance with the provisions thereof (for the avoidance of doubt, as may be amended following the date of this Agreement with the written approval of GigCapital5), be canceled without any conversion thereof and no payment or distribution shall be made, and the holder thereof shall cease to have any rights, with respect thereto. At or prior to the Effective Time, the parties and their boards, as applicable, shall adopt any resolutions and take any actions that are necessary to effectuate the treatment of the Company Warrants (including by causing or entering into any amendments thereto) pursuant to the provisions of this Section 3.01(c).

(d) Notwithstanding anything to the contrary set forth in this Agreement, (i) the portion of the Aggregate Closing Merger Consideration issuable to any Person pursuant to Section 3.01(a)(i) and Section 3.01(c) shall be calculated on an aggregate basis with respect to all shares of Company Common Stock, and all In-the-Money Company Warrant Shares subject to In-the-Money Company Warrants, held of record by such person immediately prior to the Effective Time, and (ii) after such aggregation, any fractional share of GigCapital5 Common Stock that would otherwise be issuable to such person following such aggregation shall be rounded up to a whole share of GigCapital5 Common Stock.

### **SECTION 3.02 Delivery of Shares.**

(a) On the Closing Date, GigCapital5 shall deposit, or shall cause to be deposited, with a bank or trust company that shall be designated by GigCapital5 and is reasonably satisfactory to the Company (the "Exchange Agent"), for the benefit of the Company Equity Securityholders, for exchange in accordance with this Article III, the number of shares of GigCapital5 Common Stock sufficient to deliver the aggregate Per Share Merger Consideration payable pursuant to this Agreement (such shares of GigCapital5 Common Stock, the Merger Consideration Earnout Shares and any dividends or distributions with respect thereto (pursuant to Section 3.02(c)), being hereinafter referred to as the "Exchange Fund"). GigCapital5 shall cause the Exchange Agent pursuant to irrevocable instructions, to pay the Per Share Merger Consideration out of the Exchange Fund in accordance with this Agreement. Except as contemplated by Section 3.02(c) and Section 3.07, the Exchange Fund shall not be used for any other purpose.

(b) As promptly as practicable after the effectiveness of the Registration Statement, GigCapital5 shall use its reasonable best efforts to cause the Exchange Agent to mail to each holder of Company Common Stock entitled to receive the Per Share Merger Consideration pursuant to Section 3.01: a letter of transmittal, which shall be in a form reasonably acceptable to GigCapital5 and the Company prior to the Closing (the "Letter of Transmittal") and shall specify (i) that delivery shall be effected, and risk of loss and title to the certificates evidencing such shares of Company Common Stock (the "Certificates") shall pass, only upon proper delivery of the Certificates to the Exchange Agent or confirmation of cancellation of such Certificates from the Company, (each, a "Transfer Agent Cancellation"); and (ii) instructions for use in effecting the surrender of the Certificates pursuant to the Letter of Transmittal. Within two (2) Business Days (but in no event prior to the Effective Time) after the surrender to the Exchange Agent of all

Certificates held by such holder for cancellation (or a Transfer Agent Cancellation), together with a Letter of Transmittal, duly completed and validly executed in accordance with the instructions thereto and such other documents as may be required pursuant to such instructions, the holder of such Certificates shall be entitled to receive in exchange therefore, and QTI Holdings shall cause the Exchange Agent to deliver, the Per Share Merger Consideration with respect thereto in accordance with the provisions of Section 3.01, and the Certificate so surrendered shall forthwith be cancelled. Until surrendered as contemplated by this Section 3.02, each Certificate entitled to receive the Per Share Merger Consideration in accordance with Section 3.01(a)(i) shall be deemed at all times after the Effective Time to represent only (A) the right to receive upon such surrender the Per Share Merger Consideration that such holder is entitled to receive in accordance with the provisions of Section 3.01(a)(i) and (B) the contingent right to receive a portion of the Merger Consideration Earnout Shares, if, as and when payable in accordance with the provisions of Section 3.07.

(c) No dividends or other distributions declared or made after the Effective Time with respect to the GigCapital5 Common Stock with a record date after the Effective Time shall be paid from the Exchange Fund to the holder of any unsurrendered Certificate with respect to the shares of GigCapital5 Common Stock represented thereby until the holder of such Certificate shall surrender such Certificate in accordance with Section 3.02(b). Subject to the effect of escheat, Tax or other applicable Laws, following surrender of any such Certificate, QTI Holdings shall pay or cause to be paid to the holder of the certificates representing shares of GigCapital5 Common Stock issued in exchange therefore, without interest, (i) promptly, but in any event within five (5) Business Days of such surrender, the amount of dividends or other distributions with a record date after the Effective Time and theretofore paid with respect to such shares of GigCapital5 Common Stock, and (ii) at the appropriate payment date, the amount of dividends or other distributions, with a record date after the Effective Time but prior to surrender and a payment date occurring after surrender, payable with respect to such shares of GigCapital5 Common Stock.

(d) The Per Share Merger Consideration and the Merger Consideration Earnout Shares payable upon conversion of the Company Equity Securities in accordance with the terms hereof shall be deemed to have been paid and issued in full satisfaction of all rights pertaining to such Company Equity Securities.

(e) The Per Share Merger Consideration shall be adjusted to reflect appropriately the effect of any stock split, reverse stock split, stock dividend, reorganization, recapitalization, reclassification, combination, exchange of shares or other like change with respect to GigCapital5 Common Stock occurring on or after the date hereof and prior to the Effective Time.

(f) Except as set forth in Section 3.07 hereto, any portion of the Exchange Fund that remains undistributed to the Company Equity Securityholders for one year after the Effective Time shall be delivered to QTI Holdings, upon demand, and any Company Equity Securityholders who have not theretofore complied with this Section 3.02 shall thereafter look only to QTI Holdings for the Per Share Merger Consideration. Any portion of the Exchange Fund remaining unclaimed by the applicable Company Equity Securityholders as of a date which is immediately prior to such time as such amounts would otherwise escheat to or become property of any government entity shall, to the extent permitted by applicable law, become the property of QTI Holdings free and clear of any claims or interest of any person previously entitled thereto.

(g) None of the Exchange Agent, QTI Holdings or the Surviving Corporation shall be liable to any Company Equity Securityholder for any such Company Equity Securities (or dividends or distributions with respect thereto) or cash delivered to a public official pursuant to any abandoned property, escheat or similar Law in accordance with Section 3.02.

(h) Each of the Surviving Corporation and QTI Holdings shall be entitled to deduct and withhold from the consideration otherwise payable pursuant to this Agreement to a person such amounts as it is required to deduct and withhold with respect to the making of such payment under the Code or any provision of state, local or foreign Tax law. To the extent that amounts are so withheld and timely remitted to the appropriate Governmental Authority by the Surviving Corporation or QTI Holdings, as the case may be, such withheld

amounts shall be treated for all purposes of this Agreement as having been paid to the person in respect of which such deduction and withholding was made by the Surviving Corporation or QTI Holdings, as the case may be. If the Surviving Corporation or QTI Holdings intends to withhold any Taxes from any amounts payable to holders of equity interests in the Company (other than with respect to any withholding) on amounts treated as compensation for applicable Tax purposes, QTI Holdings shall use reasonable best efforts to provide prior notice of such withholding to the Company as soon as reasonably practicable after it determines withholding is required. The Surviving Corporation, QTI Holdings and any Company Equity Securityholder, as applicable, shall reasonably cooperate to reduce or seek an exemption from any withholding, including providing the Person in respect of which such deduction and withholding was made with a reasonable opportunity to provide forms or other evidence that would exempt such amounts from withholding.

(i) If any Certificate shall have been lost, stolen or destroyed, upon the making of an affidavit of that fact by the person claiming such Certificate to be lost, stolen or destroyed, the Exchange Agent will issue in exchange for such lost, stolen or destroyed Certificate, the Per Share Merger Consideration that such holder is otherwise entitled to receive pursuant to, and in accordance with, the provisions of Section 3.01(a)(i).

**SECTION 3.03 Stock Transfer Books.** At the Effective Time, the stock transfer books of the Company shall be closed and there shall be no further registration of transfers of Company Common Stock thereafter on the records of the Company. From and after the Effective Time, the holders of Certificates representing Company Common Stock outstanding immediately prior to the Effective Time shall cease to have any rights with respect to such Company Common Stock, except as otherwise provided in this Agreement or by Law. On or after the Effective Time, any Certificates presented to the Exchange Agent or QTI Holdings for any reason shall be converted into (a) the Per Share Merger Consideration in accordance with the provisions of Section 3.01(a)(i), and (b) the contingent right to receive a portion of the Merger Consideration Earnout Shares if, as and when payable in accordance with the provisions of Section 3.07.

**SECTION 3.04 Payment of Expenses.**

(a) No sooner than five (5) or later than two (2) Business Days prior to the Closing Date, the Company shall provide to GigCapital5 a written report setting forth a list of all of the following fees, expenses and disbursements incurred by or on behalf of the Company in connection with the preparation, negotiation and execution of this Agreement and the consummation of the transactions contemplated hereby (together with paid invoices or wire transfer confirmation receipts), including such fees and expenses that have been (x) paid or will be paid prior to the close of business on the Business Day immediately preceding the Closing (collectively, the "Paid Company Transaction Expenses") or (y) incurred and expected to remain unpaid as of the close of business on the Business Day immediately preceding the Closing Date (collectively, the "Unpaid Company Transaction Expenses") and, together with the Paid Company Transaction Expenses, the "Company Transaction Expenses": (i) the amount of expenses paid by the Company pursuant to the provisions of Section 9.03; (ii) the fees and disbursements of outside legal counsel to the Company incurred in connection with the Transactions; (iii) the fees, costs and expenses associated with the Tail Policies; and (iv) the fees, costs, commissions and expenses of any other agents, advisors, consultants, experts, financial advisors, lenders, brokers and other service providers engaged by or on behalf of, or otherwise entitled to payments or other compensation from, the Company in connection with the Transactions. On the Closing Date following the Closing, QTI Holdings shall pay or cause to be paid by wire transfer of immediately available funds all such Unpaid Company Transaction Expenses (other than any such Unpaid Company Transaction Expenses to be satisfied by the issuance of shares of GigCapital5 Common Stock pursuant to the provisions of Section 3.04(d) and Section 3.04(g)). For the avoidance of doubt, the Company Transaction Expenses shall not include any fees and expenses incurred by the Company's stockholders (except to the extent incurred on behalf, and for the account, of the Company).

(b) No sooner than five (5) or later than two (2) Business Days prior to the Closing Date, GigCapital5 shall provide to the Company a written report setting forth: (i) the amount of expenses paid by GigCapital5



pursuant to the provisions of Section 9.03 (the “Paid GigCapital5 Transaction Expenses”); (ii) a list of all the fees and disbursements of outside legal counsel, agents, advisors, consultants, experts, financial advisors, lenders, brokers and other service providers engaged by or on behalf of, or otherwise entitled to payments or other compensation from, GigCapital5 or Merger Sub in connection with the Transactions or otherwise in connection with GigCapital5’s operations (together with written invoices and wire transfer instructions for the payment thereof); and (iii) a list of all costs and expenses payable to the R&W Insurance Provider in connection with the transactions contemplated herein (the fees, costs, expenses and disbursements described in the foregoing clauses (ii) and (iii), collectively, the “Unpaid GigCapital5 Transaction Expenses” and, together with the Paid GigCapital5 Transaction Expenses, the “GigCapital5 Transaction Expenses”). On the Closing Date following the Closing, QTI Holdings shall pay or cause to be paid by wire transfer of immediately available funds all such Unpaid GigCapital5 Transaction Expenses (other than any such Unpaid GigCapital5 Transaction Expenses to be satisfied by the issuance of shares of GigCapital5 Common Stock pursuant to the provisions of Section 3.04(e)).

(c) QTI Holdings shall not pay or cause to be paid any Unpaid GigCapital5 Transaction Expenses or Unpaid Company Transaction Expenses other than in accordance with this Section 3.04.

(d) Notwithstanding anything to the contrary set forth in this Agreement, if the Unpaid Company Transaction Expenses would exceed the Company Transaction Expenses Cap, the Company shall use its reasonable best efforts to cause its agents, advisors, consultants, experts, financial advisors and other service providers (other than outside legal counsel, certified public accountants, insurance companies and brokers, trust and transfer agents and other similarly situated service providers) who are or will be owed Unpaid Company Transaction Expenses to agree in writing to accept payment of such excess (or any applicable portion thereof) in the form of shares of GigCapital5 Common Stock, in lieu of cash, up to an aggregate number of shares of GigCapital5 Common Stock equal to the Aggregate Excess Company Transaction Expenses Shares, to be issued by GigCapital5 to such service providers of the Company at the Closing on terms and conditions approved in writing by GigCapital5 (such approval not to be unreasonably withheld, conditioned or delayed). Subject to the foregoing, GigCapital5 shall, at the Closing, issue such shares of GigCapital5 Common Stock to such service providers of the Company in accordance with such approved terms and conditions.

(e) Notwithstanding anything to the contrary set forth in this Agreement, if the Unpaid GigCapital5 Transaction Expenses would exceed the GigCapital5 Transaction Expenses Cap, GigCapital5 shall use its reasonable best efforts to cause its agents, advisors, consultants, experts, financial advisors and other service providers (other than outside legal counsel, certified public accountants, insurance companies and brokers, trust and transfer agents and other similarly situated service providers) who are or will be owed Unpaid GigCapital5 Transaction Expenses to agree in writing to accept payment of such excess (or any applicable portion thereof) in the form of shares of GigCapital5 Common Stock, in lieu of cash, up to an aggregate number of shares of GigCapital5 Common Stock equal to the Aggregate Excess GigCapital5 Transaction Expenses Shares, to be issued by GigCapital5 to such service providers of GigCapital5 at the Closing on terms and conditions approved in writing by the Company (such approval not to be unreasonably withheld, conditioned or delayed). Subject to the foregoing, GigCapital5 shall, at the Closing, issue such shares of GigCapital5 Common Stock to such service providers of GigCapital5 in accordance with such approved terms and conditions.

(f) If the Unpaid GigCapital5 Transaction Expenses exceed the Unpaid GigCapital5 Transaction Expenses Cap, GigCapital5 shall cause the Sponsor, at the Closing, to irrevocably forfeit and transfer to GigCapital5 a number of shares of GigCapital5 Common Stock equal to the Aggregate Excess GigCapital5 Transaction Expenses Shares, and thereafter the Sponsor shall have no further right or interest in such shares of GigCapital5 Common Stock, which shall remain in treasury at GigCapital5 until otherwise disposed of by GigCapital5 in its sole discretion.

(g) Notwithstanding anything to the contrary set forth in this Agreement, the Unpaid Company Transaction Expenses set forth on Schedule 3.04(g) shall be settled in shares of GigCapital5 Common Stock

issued to the applicable individual service providers of the Company at the Closing on the terms and conditions set forth in the written agreements between the Company and such service providers, together with any amendments thereto as may be reasonably required by GigCapital5. Subject to the foregoing, GigCapital5 shall, at the Closing, issue such shares of GigCapital5 Common Stock to such service providers of the Company in accordance with such terms and conditions, as may be amended. For the avoidance of doubt, each such share of GigCapital5 Common Stock issued pursuant to this Section 3.04(g) shall be treated as \$10.00 of Unpaid Company Transaction Expenses.

**SECTION 3.05 Appraisal Rights.**

(a) Notwithstanding any provision of this Agreement to the contrary and to the extent available under the DGCL, shares of Company Common Stock that are outstanding immediately prior to the Effective Time and that are held by stockholders of the Company who shall have neither voted in favor of the Merger nor consented thereto in writing and who shall have demanded properly in writing appraisal for such Company Common Stock in accordance with Section 262 of the DGCL and otherwise complied with all of the provisions of the DGCL relevant to the exercise and perfection of dissenters' rights shall not be converted into, and such stockholders shall have no right to receive, the Per Share Merger Consideration or the contingent right to receive any portion of the Merger Consideration Earnout Shares, unless and until such stockholder fails to perfect or withdraws or otherwise loses his, her or its right to appraisal and payment under the DGCL. Any stockholder of the Company who fails to perfect or who effectively withdraws or otherwise loses his, her or its rights to appraisal of such shares of Company Common Stock under Section 262 of the DGCL shall thereupon be deemed to have been converted into, and to have become exchangeable for, as of the Effective Time, the right to receive (i) the Per Share Merger Consideration, without any interest thereon, upon surrender, in the manner provided in Section 3.01(a)(i), of the Certificate or Certificates that formerly evidenced such shares of Company Common Stock, and a portion of the Merger Consideration Earnout Shares if, as and when payable in accordance with the provisions of Section 3.07.

(b) Prior to the Closing, the Company shall give GigCapital5 (i) prompt notice of any demands for appraisal received by the Company and any withdrawals of such demands, and (ii) the opportunity to participate in all negotiations and proceedings with respect to demands for appraisal under the DGCL. The Company shall not, except with the prior written consent of GigCapital5 (which consent shall not be unreasonably withheld), make any payment with respect to any demands for appraisal or offer to settle or settle any such demands.

**SECTION 3.06 Closing Calculations.**

(a) No later than three (3) Business Days prior to the Closing Date, the Company shall deliver to GigCapital5 a statement certified by an executive officer of Company (the "Estimated Closing Statement") setting forth Company's good faith estimate of (i) Company Closing Cash, (ii) Company Closing Debt, (iii) the Aggregate Exercise Price, and (iv) the Company Fully Diluted Capital Stock; provided, that the Company may update the Estimated Closing Statement and deliver such updated Estimated Closing Statement to GigCapital5 at any time prior to 12:01 a.m. New York time on the Closing Date.

(b) No later than two (2) Business Days prior to the Closing Date, GigCapital5 shall deliver to the Company a statement certified by an executive officer of GigCapital5 (the "GigCapital5 Closing Statement") setting forth (i) the Aggregate Closing Merger Consideration, (ii) the Aggregate Closing Merger Consideration Value, (iii) the Per Share Merger Consideration, and (iv) the number of Merger Consideration Earnout Shares that will comprise the Merger Consideration Earnout Share Pool. If the Company updates the Estimated Closing Statement following the delivery of the GigCapital5 Closing Statement, GigCapital5 shall update the GigCapital5 Closing Statement accordingly and deliver an updated GigCapital5 Closing Statement to the Company. Following the delivery of the GigCapital5 Closing Statement, if the Company has any objection to any amounts included in the GigCapital5 Closing Statement, GigCapital5 and the Company shall reasonably cooperate in good faith to resolve such objection.

(c) No later than one (1) Business Day prior to the Closing Date, the Company shall deliver to GigCapital5 a statement certified by an executive officer of the Company setting forth the Aggregate Closing Merger Consideration that will be payable to each holder of shares of Company Common Stock issued and outstanding as of immediately prior to the Effective Time, the stock certificate numbers with respect thereto, and such other information as GigCapital5 may reasonably request of the Company.

### **SECTION 3.07 Earnout**

(a) After the Closing, subject to the terms and conditions set forth herein, the Company Equity Securityholders shall have the contingent right to receive additional shares of GigCapital5 Common Stock based on the performance of QTI Holdings if the requirements as set forth in this Section 3.07 are achieved. At the Closing and immediately prior to the Effective Time, GigCapital5 shall deliver to the Exchange Fund the Merger Consideration Earnout Share Pool. The Merger Consideration Earnout Shares shall be allocated among the Company Equity Securityholders in accordance with this Section 3.07.

(b) Promptly upon the occurrence of any triggering event described in Section 3.07(c) below, or as soon as practicable after QTI Holdings becomes aware of the occurrence of such triggering event or receives written notice of such triggering event, QTI Holdings shall prepare and deliver, or cause to be prepared and delivered, a written notice to the Exchange Agent (a "Release Notice"), which Release Notice shall set forth in reasonable detail the triggering event giving rise to the requested release and the specific release instructions with respect thereto (including the number of Merger Consideration Earnout Shares to be released from the Exchange Fund and the identity of the person to whom they should be released). The Merger Consideration Earnout Shares that are to be released from the Exchange Fund and distributed to the Company Equity Securityholders shall be distributed to such Company Equity Securityholders in accordance with their respective Pro Rata Shares. For the avoidance of doubt, any Merger Consideration Earnout Shares to be released and distributed pursuant to this Section 3.07 shall be distributed and released as shares of GigCapital5 Common Stock.

(c) The Merger Consideration Earnout Shares shall be released and delivered as follows:

(i) promptly following the date on which QTI Holdings files its annual report on Form 10-K with respect to its fiscal year ended December 31, 2023 (the "2023 Form 10-K") with the SEC, an aggregate of 2,500,000 Merger Consideration Earnout Shares (the "2023 Earnout Shares") will be released from the Exchange Fund and distributed to the Company Equity Securityholders in accordance with their respective Pro Rata Shares if, and only if, on or prior to such filing date, the Company has obtained a formal FDA clearance for breast cancer screening with respect to its breast scanning systems, which remains in full force and effect as of such filing date; provided, that the 2023 Earnout Shares shall increase by 500,000 (to an aggregate of 3,000,000) Merger Consideration Earnout Shares if, in addition, during calendar year 2023, the Company either (A) makes at least eight bona fide placements of its breast scanning systems globally or (B) achieves annual revenue of at least \$4,400,000 as set forth in the financial statements included in the 2023 Form 10-K;

(ii) promptly following the date on which QTI Holdings files its annual report on Form 10-K with respect to its fiscal year ended December 31, 2024 (the "2024 Form 10-K") with the SEC, an aggregate of 2,500,000 Merger Consideration Earnout Shares (the "2024 Earnout Shares") will be released from the Exchange Fund and distributed to the Company Equity Securityholders in accordance with their respective Pro Rata Shares if, and only if, during calendar year 2024, (A) the Company achieves annual revenue of at least \$17,100,000 as set forth in the financial statements included in the 2024 Form 10-K, and (B) the Company makes at least four placements of its breast scanning systems in the United States; provided, that the 2024 Earnout Shares shall increase by 500,000 (to an aggregate of 3,000,000) Merger Consideration Earnout Shares if at least one of the following milestones is achieved: (x) on or prior to such filing date, the Company has obtained a formal FDA clearance for a new indication for use of its breast scanning systems (other than any indication obtained prior to calendar year 2024), which remains in full force and effect as of such filing date; or (y) the Company achieves clinical-quality patient images with the Company's open angle scanner during the 2024 calendar year, as reported in the 2024 Form 10 K;

(iii) promptly following the date on which QTI Holdings files its annual report on Form 10-K with respect to its fiscal year ended December 31, 2025 (the “2025 Form 10-K”), an aggregate of 2,500,000 Merger Consideration Earnout Shares (the “2025 Earnout Shares”) will be released from the Exchange Fund and distributed to the Company Equity Securityholders in accordance with their respective Pro Rata Shares if, and only if, during calendar year 2025, (A) the Company achieves annual revenue of at least \$67,000,000 as set forth in the financial statements included in the 2025 Form 10-K, or (B) the VWAP of shares of GigCapital5 Common Stock equals or exceeds \$15 per share for twenty (20) of any thirty (30) consecutive trading days on the Exchanges; provided, that the 2025 Earnout Shares shall increase by 500,000 (to an aggregate of 3,000,000) Merger Consideration Earnout Shares if at least one of the following milestones is achieved on or prior to such filing date: (x) the Company has obtained a formal FDA clearance of its open angle scanner, which remains in full force and effect as of such filing date; or (y) the Company receives net positive results in bona fide clinical trials, conducted in accordance with generally accepted industry standards, for its open angle scanner, as reported in the 2025 Form 10-K; and

(iv) if the conditions set forth in Section 3.07(c)(i), Section 3.07(c)(ii) or Section 3.07(c)(iii) for any Merger Consideration Earnout Shares to be released from the Exchange Fund and distributed to the Company Equity Securityholders have not been, and become incapable of being, satisfied, then promptly thereafter such Merger Consideration Earnout Shares shall be automatically released to QTI Holdings for cancellation and the Company Equity Securityholders shall not have any right to receive such Merger Consideration Earnout Shares or any benefit therefrom.

(d) The GigCapital5 Common Stock price targets set forth in Section 3.07(c) and the number of shares of GigCapital5 Common Stock to be issued and released pursuant to Section 3.07(c) shall be equitably adjusted for any stock dividend, subdivision, reclassification, recapitalization, split, combination or exchange of shares, or any similar event affecting the GigCapital5 Common Stock after the date of this Agreement.

(e) As used in this Section 3.07, the term “Pro Rata Share” means, with respect to each Company Equity Securityholder, a ratio calculated by *dividing* (i) the sum of, without duplication, (A) the total number of shares of Company Common Stock held by such Company Equity Securityholder as of immediately prior to the Effective Time, *plus* (B) the total number of In-the-Money Company Warrant Shares subject to In-the-Money Company Warrants held by such Company Equity Securityholder as of immediately prior to the Effective Time (to the extent such In-the-Money Company Warrants are not exercised or deemed exercised as of immediately prior to the Effective Time), *by* (ii) the sum of, without duplication, (A) the total number of shares of Company Common Stock held by all Company Equity Securityholders as of immediately prior to the Effective Time, *plus* (B) the total number of In-the-Money Warrant Shares (to the extent the applicable In-the-Money Company Warrants are not exercised or deemed exercised as of immediately prior to the Effective Time).

(f) Notwithstanding anything to the contrary set forth in this Agreement, any fractional Merger Consideration Earnout Share that would otherwise be issuable to any person pursuant to this Section 3.07 shall be rounded up to a whole share of GigCapital5 Common Stock.

**ARTICLE IV.  
REPRESENTATIONS AND WARRANTIES OF THE COMPANY**

Except as set forth in the Company's disclosure schedule delivered by the Company in connection with this Agreement (the "Company Disclosure Schedule"), the Company hereby represents and warrants to GigCapital5 and Merger Sub as follows:

**SECTION 4.01 Organization and Qualification: Subsidiaries.**

(a) The Company and each subsidiary of the Company (each a "Company Subsidiary"), is a corporation or other organization duly organized, validly existing and in good standing under the laws of the jurisdiction of its incorporation or organization and has the requisite corporate or other organizational power and authority and all necessary governmental approvals to own, lease and operate its properties and to carry on its business as it is now being conducted. The Company and each Company Subsidiary is duly qualified or licensed as a foreign corporation or other organization to do business, and is in good standing, in each jurisdiction where the character of the properties owned, leased or operated by it or the nature of its business makes such qualification or licensing necessary, except for such failures to be so qualified or licensed and in good standing that do not constitute a Company Material Adverse Effect.

(b) A true and complete list of all the Company Subsidiaries, together with the jurisdiction of incorporation of each Company Subsidiary and the percentage of the outstanding capital stock of each Company Subsidiary owned by the Company and each other Company Subsidiary, is set forth in Schedule 4.01(b) of the Company Disclosure Schedule. The Company does not directly or indirectly own any equity or similar interest in, or any interest convertible into or exchangeable or exercisable for any equity or similar interest in, any other corporation, partnership, joint venture or business association or other entity.

**SECTION 4.02 Certificate of Incorporation and Bylaws.** The Company has prior to the date of this Agreement made available a complete and correct copy of the certificate of incorporation and the bylaws or equivalent organizational documents, each as amended to date, of the Company and each Company Subsidiary. Such certificates of incorporation, bylaws or equivalent organizational documents are in full force and effect. Neither the Company nor any Company Subsidiary is in violation of any of the provisions of its certificate of incorporation, bylaws or equivalent organizational documents.

**SECTION 4.03 Capitalization.**

(a) The authorized capital stock of the Company consists of one hundred million (100,000,000) shares of Company Common Stock and ten million (10,000,000) shares of Preferred Stock of the Company (the "Company Preferred Stock"). As of the date hereof, (i) twenty-seven million four hundred forty-two thousand five hundred forty (27,442,540) shares of Company Common Stock are issued and outstanding, (ii) no shares of Company Preferred Stock are outstanding, (iii) no shares of Company Common Stock are held in the treasury of the Company, (iv) three million nine hundred forty thousand five hundred thirty-six (3,940,536) shares of Company Common Stock are reserved for future issuance pursuant to outstanding Company Options and other purchase rights granted pursuant to the Company Option Plan (the "Company Share Awards"), (v) Company Warrants to purchase seven hundred sixty-seven thousand nine hundred seventy (767,970) shares of Company Common Stock are issued and outstanding, (vi) seven hundred four thousand five hundred sixty-five (704,565) shares of Company Common Stock are reserved for future conversion pursuant to the Converting Notes and (vii) eight hundred five thousand nine hundred fifteen (805,915) shares of Company Common Stock are reserved for future conversion pursuant to the Surviving Notes.

(b) Other than the Company Options, the Company Warrants, and the Company Convertible Notes, there are no options, restricted shares, restricted share units, phantom equity awards, warrants, preemptive

rights, calls, convertible securities, conversion rights or other rights, agreements, arrangements or commitments of any character relating to the issued or unissued capital stock of the Company or any Company Subsidiary or obligating the Company or any Company Subsidiary to issue or sell any shares of capital stock of, or other equity interests in, the Company or any Company Subsidiary. Neither the Company nor any Company Subsidiary is a party to, or otherwise bound by, and neither the Company nor any Company Subsidiary has granted, any equity appreciation rights, participations, phantom equity or similar rights. There are no voting trusts, voting agreements, proxies, shareholder agreements or other agreements with respect to the voting or transfer of the Company Common Stock, Company Preferred Stock or any of the equity interests or other securities of the Company or any of the Company Subsidiaries. The Company does not own any equity interests in any person, other than the Company Subsidiaries.

(c) Schedule 4.03(c) of the Company Disclosure Schedule sets forth, as of the date of this Agreement, the following information with respect to each Company Share Award outstanding: (i) the Company identification with respect to each Company Share Award; (ii) the number of shares of the Company subject to such Company Share Award; (iii) the exercise or purchase price of such Company Share Award, (iv) the date on which such Company Share Award was granted; (v) the vesting schedule of such Company Share Award; and (vi) the date on which such Company Share Award expires. The Company has made available to GigCapital5 an accurate and complete copy of the Company Option Plan pursuant to which Company has granted the Company Share Awards that are currently outstanding and the form of all award agreements evidencing such Company Share Awards.

(d) No Company Option was granted with an exercise price per share less than the fair market value (pursuant to Section 409A or Section 422, as applicable, of the Code) of the underlying Company Common Stock as of the date such Company Option was granted. All shares of the Company subject to issuance as aforesaid, upon issuance on the terms and conditions specified in the instruments pursuant to which they are issuable, will be duly authorized, validly issued, fully paid and nonassessable. No shares of Company Common Stock are subject to vesting as of the date hereof and no Company Options are “early exercisable” as of the date hereof. The treatment of Company Options under Section 3.01(b) hereof is permitted under the Company Option Plan, applicable Laws, and the underlying individual agreements for such Company Share Awards without obtaining the consent of any holder thereof. The Company has no outstanding commitments to grant Company Options.

(e) Schedule 4.03(e) of the Company Disclosure Schedule sets forth, as of the date of this Agreement, the following information with respect to each Company Warrant outstanding: (i) the name of the holder of such Company Warrant; (ii) the number of shares of the Company subject to such Company Warrant; (iii) the exercise or purchase price of such Company Warrant; (iv) the date on which such Company Warrant was granted; and (v) the date on which such Company Warrant expires. The Company has made available to GigCapital5 an accurate and complete copy of each Company Warrant. All shares of the Company subject to issuance pursuant to any Company Warrant, upon issuance on the terms and conditions specified therein, will be duly authorized, validly issued, fully paid and nonassessable. The Company has reserved seven hundred sixty-seven thousand nine hundred seventy (767,970) shares of Company Common Stock for future issuance pursuant to the Company Warrants. Each of the Company Warrants shall be exercised in full for shares of Company Common Stock prior to the Closing, cancelled, or is or will be capable of being assumed by GigCapital5 as contemplated by Section 3.01(b), without any further consent or action by the holder thereof. Schedule 4.03(e) of the Company Disclosure Schedule sets forth, under the heading “Pre-Signing In-the-Money Company Warrants,” each Company Warrant that, to the extent such Company Warrant remains outstanding immediately prior to the Closing, would constitute an “in-the-money” Company Warrant with respect to the transactions contemplated by this Agreement (collectively, the “Pre-Signing In-the-Money Company Warrants”).

(f) Schedule 4.03(f) of the Company Disclosure Schedule sets forth, as of the date of this Agreement, the following information with respect to the Company Convertible Notes: (i) the name of each holder of any of the Company Convertible Notes; (ii) the aggregate amount of principal and interest outstanding under each of the Company Convertible Notes as of the date of this Agreement; (iii) the interest rate applicable to

each of the Company Convertible Notes; and (iv) the maturity date of each of the Company Convertible Notes. The Company has made available to GigCapital5 accurate and complete copies of the Company Convertible Notes. All shares of the Company subject to issuance pursuant to the Company Convertible Notes, upon issuance on the terms and conditions specified therein, will be duly authorized, validly issued, fully paid and nonassessable. The Company has reserved one million five hundred thousand ten four hundred eighty (1,510,480) shares of Company Common Stock for future issuance pursuant to the Company Convertible Notes.

(g) There are no outstanding contractual obligations of the Company or any Company Subsidiary to repurchase, redeem or otherwise acquire any shares of the Company or any capital stock of any Company Subsidiary or to provide funds to or make any investment (in the form of a loan, capital contribution or otherwise) in any person other than a Company Subsidiary.

(h) (i) There are no commitments or agreements of any character to which the Company is bound obligating the Company to accelerate the vesting of any Company Share Award or Company Option as a result of the proposed transactions herein, and (ii) all outstanding shares of the Company, all outstanding Company Share Awards and Company Options, all outstanding Company Warrants, all outstanding Company Convertible Notes and all outstanding shares of capital stock of each Company Subsidiary have been issued and granted in compliance with (A) all applicable securities laws and other applicable laws and (B) all pre-emptive rights and other requirements set forth in applicable contracts to which the Company or any Company Subsidiary is a party.

(i) Each outstanding share of capital stock of each Company Subsidiary is duly authorized, validly issued, fully paid and nonassessable, and each such share is owned by the Company or another Company Subsidiary free and clear of all Liens, options, rights of first refusal and limitations on the Company's or any Company Subsidiary's voting rights, other than transfer restrictions under applicable securities laws and their respective organizational documents.

(j) The stockholders of the Company collectively own directly and beneficially and of record, all of the equity of the Company (which are represented by the issued and outstanding shares of the Company). Except for the shares of the Company held by the stockholders of the Company, no other shares or other equity or voting interest of the Company are authorized or issued and outstanding, and no options, warrants or other rights to acquire any shares or other equity or voting interest, of the Company though authorized and reserved are issued and outstanding.

(k) All outstanding shares of Company Common Stock and all outstanding shares of capital stock or other equity securities (as applicable) of each Company Subsidiary have been issued and granted in compliance with (A) applicable securities laws and other applicable laws and (B) any pre-emptive rights and other similar requirements set forth in applicable contracts to which the Company or any Company Subsidiary is a party.

**SECTION 4.04 Authority Relative to this Agreement.** The Company has all necessary power and authority to execute and deliver this Agreement, to perform its obligations hereunder and, subject to receiving the Company Stockholder Approval, to consummate the Transactions. The execution and delivery of this Agreement by the Company and the consummation by the Company of the Transactions have been duly and validly authorized by all necessary corporate action, and no other corporate proceedings on the part of the Company are necessary to authorize this Agreement or to consummate the Transactions (other than, with respect to the Merger, the Company Stockholder Approval, which the Written Consent shall satisfy, and the filing and recordation of appropriate merger documents as required by the DGCL). This Agreement has been duly and validly executed and delivered by the Company and, assuming the due authorization, execution and delivery by GigCapital5 and Merger Sub, constitutes a legal, valid and binding obligation of the Company, enforceable against the Company in accordance with its terms, except as limited by applicable bankruptcy, insolvency, reorganization, moratorium and other laws of general application affecting enforcement of creditors' rights generally, by general equitable principles (the "Remedies Exceptions"). The Company Board has approved this Agreement and the Transactions,

and such approvals are sufficient so that the restrictions on business combinations set forth in Section 203 of the DGCL shall not apply to the Merger, this Agreement, the Stockholder Support Agreement, any Ancillary Agreement or any of the other Transactions. To the knowledge of the Company, no other state takeover statute is applicable to the Merger or the other Transactions.

**SECTION 4.05 No Conflict; Required Filings and Consents.**

(a) The execution and delivery of this Agreement by the Company does not, and subject to receipt of the filing and recordation of appropriate merger documents as required by the DGCL and of the consents, approvals, authorizations or permits, filings and notifications contemplated by Schedule 4.05(a) of the Company Disclosure Schedule, the performance of this Agreement by the Company will not (i) conflict with or violate the certificate of incorporation or bylaws or any equivalent organizational documents of the Company or any Company Subsidiary, (ii) conflict with or violate any statute, law, ordinance, regulation, rule, code, executive order, injunction, binding guidance, judgment, decree or other order, in each case, of any Governmental Authority or self-regulatory body ("Law(s)") applicable to the Company or any Company Subsidiary, by which any property or asset of the Company or any Company Subsidiary is bound or affected or which the Company or any Company Subsidiary has agreed to comply with, or (iii) result in any breach of or constitute a default (or an event which, with notice or lapse of time or both, would become a default) under, or give to others any right of termination, amendment, acceleration or cancellation of, or result in the creation of a Lien (other than any Permitted Lien) on any material property or asset of the Company or any Company Subsidiary pursuant to, any Material Contract, except, with respect to clauses (ii) and (iii), for any such conflicts, violations, breaches, defaults or other occurrences which do not constitute a Company Material Adverse Effect.

(b) The execution and delivery of this Agreement by the Company does not, and the performance of this Agreement by the Company will not, require any consent, approval, authorization or permit of, or filing with or notification to, any United States federal, state, provincial, county, municipal or local or non-United States government, governmental or quasi-governmental, regulatory or administrative authority or office, any political or other subdivision thereof, agency, instrumentality, bureau, ministry, authority, body or commission or any court, tribunal, or judicial or arbitral body (a "Governmental Authority"), except (i) for applicable requirements, if any, of the Exchange Act, state securities or "blue sky" laws ("Blue Sky Laws") and state takeover laws, the pre-merger notification requirements of the HSR Act, and filing and recordation of appropriate merger documents as required by the DGCL, and (ii) where the failure to obtain such consents, approvals, authorizations or permits, or to make such filings or notifications, does not constitute a Company Material Adverse Effect.

**SECTION 4.06 Permits; Compliance.** Each of the Company and the Company Subsidiaries is in possession, and have at all time in the past six (6) years possessed, of all material franchises, grants, authorizations, licenses, permits, easements, variances, exceptions, consents, certificates, certifications, approvals, clearances, exemptions, registrations, listings, and orders of any Governmental Authority necessary for each of the Company or the Company Subsidiaries to own, lease and operate its properties or to carry on its business as it is now being conducted (the "Company Permits"), except where the failure to have such Company Permits would not reasonably be expected to have a Company Material Adverse Effect. No suspension or cancellation of any of the Company Permits is pending or, to the knowledge of the Company, threatened in writing. Neither the Company nor any Company Subsidiary is in conflict with, or in default, breach or violation of, (a) any Law applicable to the Company or any Company Subsidiary or by which any property or asset of the Company or any Company Subsidiary is bound or affected, or (b) any Material Contract or Company Permit, except, in each case, for any such conflicts, defaults, breaches or violations that do not constitute a Company Material Adverse Effect.

**SECTION 4.07 Regulatory Matters.**

(a) All of the Company Products are being and have been manufactured, processed, developed, packaged, labeled, promoted, marketed, sold, stored, tested, distributed, imported and exported in material



compliance with all applicable requirements under any applicable Law, including all Laws regarding non-clinical testing, clinical research, establishment registration, drug and device listing, good manufacturing practices, record-keeping, adverse event reporting, and reporting of corrections and removals.

(b) The Company has timely filed with the applicable regulatory authorities (including, without limitation, the FDA or any other Governmental Authority performing functions similar to those performed by the FDA) all material filings, documents, declarations, listings, registrations, reports, statements, amendments, supplements or submissions, including but not limited to adverse event reports, required to be filed by it under applicable Law, including all Laws and/or those regarding non-clinical testing, clinical research, establishment registration, drug and device listing, good manufacturing practices, record-keeping, adverse event reporting, and reporting of corrections and removals. All such filings, documents, declarations, listings, registrations, reports, statements, amendments, supplements or submissions were in material compliance with applicable Laws when filed, and no material deficiencies have been asserted by any applicable Governmental Authority with respect to any such filings, documents, declarations, listing, registrations, reports, statements, amendments, supplements or submissions. To the knowledge of the Company, (i) each such filing was true and correct in all material respects as of the date of submission, or was corrected in or supplemented by a subsequent filing, and (ii) any material and legally necessary or required updates, changes, corrections, amendments, supplements or modifications to such filings have been submitted to the applicable Governmental Authority.

(c) Except as set forth on Schedule 4.07(c) of the Company Disclosure Schedule, the Company has not received any notification of any pending or, to the knowledge of the Company, threatened (i) action, suit, claim, investigation, proceeding or order alleging potential or actual non-compliance with any Company Permits or Laws; or (ii) non-ordinary course audit, inspection or investigation by any Governmental Authority.

(d) No Company Product has been seized, withdrawn, recalled, detained or subject to a suspension of manufacturing and there are no facts or circumstances reasonably likely to cause the seizure, denial, withdrawal, recall, detention, field notification, field correction, safety alert or suspension of manufacturing relating to any such product. No proceedings in the United States or any other jurisdiction seeking the withdrawal, recall, correction, suspension, import detention or seizure of any such Company Product are pending or, to the knowledge of the Company, threatened against the Company.

(e) The Company has not received or been subject to any action, notice, warning, administrative proceeding, review, or investigation by a Governmental Authority, including any FDA Form 483, FDA warning letter or untitled letter or any similar notice, that (i) alleged or asserted that the Company violated any applicable Laws, (ii) commenced, or threatened to initiate, any action, suit, claim, investigation, proceeding or order to withdraw a premarket clearance or investigational device exemption of any Company Product or product candidate, (iii) commenced, or threatened to initiate, any action, suit, claim, investigation, proceeding or order to enjoin manufacture or distribution of any Company Product or product candidate; or (iv) commenced, or threatened to initiate any action, suit, claim, investigation, proceeding or order to change the labeling or classification of any Company Product or product candidate.

(f) Neither the Company nor, to the knowledge of the Company, any of its officers, employees or agents (i) is or has been debarred under 21 USC § 335a or excluded pursuant to 42 U.S.C. § 1320a-7, or equivalent actions under the Laws in any jurisdiction, (ii) has been convicted of any crime or engaged in any conduct that would reasonably be expected to result in debarment under 21 USC § 335a or exclusion pursuant to 42 U.S.C. § 1320a-7 or equivalent actions under the Laws in any jurisdiction, or (iii) has been convicted of, charged with or investigated for any violation of Law related to fraud, theft, embezzlement, breach of fiduciary duty, financial misconduct, controlled substances or obstruction of an investigation.

(g) To the knowledge of the Company, Neither the Company nor, to the knowledge of the Company, any of its officers, employees or agents has (i) made an untrue statement of material fact or fraudulent statement to the FDA or any other Governmental Authority, (ii) failed to disclose a material fact required to

be disclosed to the FDA or any other Governmental Authority or (iii) committed any other act, made any statement or failed to make any statement, that (in any such case) establishes a reasonable basis for a Governmental Authority to allege a violation of any applicable Law, including without limitation, for the FDA to invoke its Fraud, Untrue Statements of Material Facts, Bribery, and Illegal Gratuities Final Policy. Neither the Company nor, to the knowledge of the Company, any of its officers, employees, or agents is the subject of any pending or threatened investigation by the FDA pursuant to its Fraud, Untrue Statements of Material Facts, Bribery, and Illegal Gratuities Final Policy or by any other Government Entity pursuant to any similar Law.

#### **SECTION 4.08 Financial Statements.**

(a) The Company has made available to GigCapital5 true and complete copies of the audited consolidated balance sheets and the related audited consolidated statements of operations, changes in stockholders' equity and cash flows of the Company and the Company Subsidiaries for the year ended December 31, 2020, and unaudited consolidated balance sheets and the related unaudited consolidated statements of operations of the Company and the Company Subsidiaries for the year ended December 31, 2021 (collectively, the "Prior Financial Statements"), which are attached as Schedule 4.08(a) of the Company Disclosure Schedule. Each of the Prior Financial Statements (including the notes thereto) (i) was prepared in accordance with United States generally accepted accounting principles ("GAAP") applied on a consistent basis throughout the periods indicated (except as may be indicated in the notes thereto) and (ii) fairly presents, in all material respects, the financial position, results of operations, changes in stockholders' equity and cash flows of the Company and the Company Subsidiaries as at the date thereof and for the period indicated therein, except as otherwise noted therein and subject to the absence of notes.

(b) The Company has made available to GigCapital5 a true and complete copy of the consolidated unaudited balance sheet of the Company and the Company Subsidiaries for the nine month period ended September 30, 2022 (the "2022 Balance Sheet"), and the related Company CFO or equivalent person's reviewed consolidated statements of operations, of the Company and the Company Subsidiaries for the nine month period then ended, which are attached as Schedule 4.08(b) of the Company Disclosure Schedule (such financial statements, including the 2022 Balance Sheet, collectively with the Prior Financial Statements, the "Financial Statements"). Such unaudited financial statements were prepared in accordance with GAAP applied on a consistent basis throughout the periods indicated (except for the omission of footnotes and subject to year-end adjustments, none of which are individual or in the aggregate material) and fairly present, in all material respects, the financial position, results of operations, changes in stockholders' equity and cash flows of the Company and the Company Subsidiaries as at the date thereof and for the period indicated therein, except as otherwise noted therein and subject to normal and recurring year-end adjustments (none of which are individually or in the aggregate material) and the absence of notes.

(c) Except as and to the extent set forth on the Financial Statements, neither the Company nor any Company Subsidiary has any liability or obligation of a nature (whether accrued, absolute, contingent or otherwise) required to be reflected on a balance sheet prepared in accordance with GAAP, except for: (i) liabilities that were incurred in the ordinary course of business since the date of the 2022 Balance Sheet, (ii) obligations for future performance under any contract to which the Company or any Company Subsidiary is a party, or (iii) liabilities and obligations which are not, individually or in the aggregate, expected to result in a Company Material Adverse Effect.

(d) Since January 1, 2020, (i) neither the Company nor any Company Subsidiary nor, to the Company's knowledge, any director, officer, employee, auditor, accountant or Representative of the Company or any Company Subsidiary, has received or otherwise had or obtained knowledge of any complaint, allegation, assertion or claim, whether written or, to the knowledge of the Company, oral, regarding the accounting or auditing practices, procedures, methodologies or methods of the Company or any Company Subsidiary or their respective internal accounting controls, including any such complaint, allegation, assertion or claim that the Company or any Company Subsidiary has engaged in questionable accounting or auditing practices and (ii) there have been no internal investigations regarding accounting or revenue recognition discussed

with, reviewed by or initiated at the direction of the chief executive officer, chief financial officer, general counsel, the Company Board or any committee thereof.

(e) To the knowledge of the Company, no employee of the Company or any Company Subsidiary has provided or is providing information to any law enforcement agency regarding the commission or possible commission of any crime or the violation or possible violation of any applicable Law. None of the Company, any Company Subsidiary or, to the knowledge of the Company any officer, employee, contractor, subcontractor or agent of the Company or any such Company Subsidiary has discharged, demoted, suspended, threatened, harassed or in any other manner discriminated against an employee of the Company or any Company Subsidiary in the terms and conditions of employment because of any act of such employee described in 18 U.S.C. Sec. 1514A(a).

(f) All accounts receivable of the Company and the Company Subsidiaries reflected on the Financial Statements or arising after the date of the 2022 Balance Sheet have arisen from bona fide transactions in the ordinary course of business consistent with past practices and in accordance with GAAP and are collectible, subject to bad debts reserved in the Financial Statements. To the knowledge of the Company, such accounts receivable are not subject to valid defenses, setoffs or counterclaims, other than routine credits granted for errors in ordering, shipping, pricing, discounts, rebates, returns in the ordinary course of business and other similar matters. The Company's reserve for contractual allowances and doubtful accounts is adequate in all material respects and has been calculated in a manner consistent with past practices. Since December 31, 2021, neither the Company nor any of the Company Subsidiaries has modified or changed in any material respect its sales practices or methods including, without limitation, such practices or methods in accordance with which the Company or any of the Company Subsidiaries sell goods, fill orders or record sales.

(g) Except as set forth in Schedule 4.08(g) of the Company Disclosure Schedule, all accounts payable of the Company and the Company Subsidiaries reflected on the Financial Statements or arising after the date of the 2022 Balance Sheet are the result of bona fide transactions in the ordinary course of business and have been paid or are not yet due or payable. Since the 2022 Balance Sheet, the Company and the Company Subsidiaries have not altered in any material respects their practices for the payment of such accounts payable, including the timing of such payment.

**SECTION 4.09 Absence of Certain Changes or Events.** Since the 2022 Balance Sheet, and prior to the date of this Agreement, except as otherwise reflected in the Prior Financial Statements, or as expressly contemplated by this Agreement, (a) the Company and the Company Subsidiaries have conducted their respective businesses in all material respects in the ordinary course and in a manner consistent with past practice, (b) the Company and the Company Subsidiaries have not sold, assigned or otherwise transferred any right, title, or interest in or to any of their material assets (including Intellectual Property and Business Systems) other than non-exclusive licenses or assignments or transfers in the ordinary course of business, (c) there has not been any Company Material Adverse Effect, and (d) none of the Company or any Company Subsidiary has taken any action that, if taken after the date of this Agreement, would constitute a material breach of any of the covenants set forth in Section 6.01.

**SECTION 4.10 Absence of Litigation.** There is no, and for the past four (4) years has been no, material litigation, suit, claim, action, proceeding, audit or investigation by or before any Governmental Authority (an "Action") pending or, to the knowledge of the Company, threatened against the Company or any Company Subsidiary, or any directors, officers or employees thereof in their respective capacities as such, or any property or asset of the Company or any Company Subsidiary before any Governmental Authority. Neither the Company nor any Company Subsidiary nor any property or asset of the Company or any Company Subsidiary is, subject to any continuing order of, consent decree, settlement agreement or other similar written agreement with, or, to the knowledge of the Company, continuing investigation by, any Governmental Authority, or any order, writ, judgment, injunction, decree, determination or award of any Governmental Authority, in each case, that would, individually or in the aggregate, reasonably be expected to have a Company Material Adverse Effect.

#### SECTION 4.11 Employee Benefit Plans.

(a) All employment and consulting contracts or agreements to which the Company or any Company Subsidiary is a party, and with respect to which the Company, any Company Subsidiary or any ERISA Affiliate has or may have any obligation have been made available to GigCapital5. Schedule 4.11(a) of the Company Disclosure Schedule lists, as of the date of this Agreement, all employee benefit plans (as defined in Section 3(3) of the Employee Retirement Income Security Act of 1974, as amended (“ERISA”)) and all bonus, commission, stock option, stock purchase, restricted stock, incentive, deferred compensation, retiree medical or life insurance, supplemental retirement, severance, change in control, employment, consulting, fringe benefit, sick pay and vacation or paid time off plans or arrangements or other compensation and employee benefit plans, programs or arrangements, in each case which are maintained, contributed to or sponsored by the Company, any Company Subsidiary or any ERISA Affiliate for the benefit of any current or former employee, officer, director, consultant, or other eligible service provider, or under which the Company or any Company Subsidiary has or could incur any liability (contingent or otherwise) (collectively, the “Plans”).

(b) With respect to each Plan, the Company has made available to GigCapital5, if applicable (i) a true and complete copy of the current plan document (or written summaries of any unwritten Plans) and all amendments thereto and each trust or other funding arrangement, (ii) copies of the most recent summary plan description and any summaries of material modifications thereto, (iii) a copy of the filed IRS Form 5500 annual report and accompanying schedules for the last three years for each Plan, (iv) copies of the most recently received IRS determination, opinion or advisory letter for each such Plan, (v) any material non-routine correspondence from any Governmental Authority with respect to any Plan within the past three (3) years, (vi) nondiscrimination and other compliance testing reports for each Plan for the last three years, and (vii) any written reports constituting a valuation of the shares of Company Common Stock for purposes of Section 409A or 422 of the Code, whether prepared internally by the Company or by an outside, third-party valuation firm. Neither the Company, any Company Subsidiary nor any ERISA Affiliate has any express commitment to modify, change or terminate any Plan, other than with respect to a modification, change or termination required by ERISA or the Code, or other applicable Law.

(c) None of the Plans is or was within the past six (6) years, nor does the Company, a Company Subsidiary nor any ERISA Affiliate have or reasonably expect to have any liability or obligation under (i) a multiemployer plan (within the meaning of Section 3(37) or 4001(a)(3) of ERISA), (ii) a single employer pension plan (within the meaning of Section 4001(a)(15) of ERISA) subject to Section 412 of the Code and/or Title IV of ERISA, and (iii) a multiple employer plan subject to Section 413(c) of the Code. The Company does not have or reasonably expect to have any liability under a multiple employer welfare arrangement under ERISA. None of the Plans that is intended to be qualified under Section 401(a) of the Code has ever held employer securities or employer real property as a plan asset. For purposes of this Agreement, “ERISA Affiliate” shall mean any entity that together with another person would be deemed a “single employer” with such person for purposes of Section 4001(b)(1) of ERISA and/or Sections 414(b), (c) and/or (m) of the Code.

(d) Neither the Company nor any Company Subsidiary is or, pursuant to its current terms, will be obligated, whether under any Plan or otherwise, to pay separation, severance, termination or similar benefits to any person directly as a result of any Transaction contemplated by this Agreement (or any related event, such as termination of employment, preceding or following this Agreement), nor will any such Transaction accelerate the time of payment or vesting, or increase the amount, of any benefit or other compensation due to any individual (or any related event, such as termination of employment, preceding or following this Agreement).

(e) None of the Plans provides, nor does the Company or any Company Subsidiary have or reasonably expect to have any obligation to provide retiree medical, life, disability or other health benefits to any current or former employee, officer, director or consultant of the Company or any Company Subsidiary after termination of employment or service except as may be required under Section 4980B of the Code and Parts 6 and 7 of Title I of ERISA and the regulations thereunder or any similar State coverage continuation Law.

(f) Each Plan is and has been within the past six (6) years administered in compliance with its terms and, in all material respects, in compliance with the requirements of all applicable Laws including, without limitation, ERISA and the Code. The Company, any Company Subsidiary and its ERISA Affiliates have performed, in all material respects, all obligations required to be performed by them under, are not in any respect in default under or in violation of, and have no knowledge of any default or violation in any respect by any party to, any Plan that has resulted or is reasonably likely to result in liability to the Company or any Company Subsidiary. No Action is pending or, to the knowledge of the Company, any Company Subsidiary or ERISA Affiliate, threatened with respect to any Plan (other than claims for benefits in the ordinary course) and, to the knowledge of the Company, any Company Subsidiary or ERISA Affiliate, no fact or event exists that would reasonably be expected to give rise to any such Action.

(g) Each Plan that is intended to be qualified under Section 401(a) of the Code or Section 401(k) of the Code has (i) timely received a favorable determination letter from the IRS covering all of the provisions applicable to the Plan for which determination letters are currently available that the Plan is so qualified and each trust established in connection with such Plan is exempt from federal income taxation under Section 501(a) of the Code or (ii) with respect to a preapproved plan, is entitled to rely on a favorable opinion or advisory letter from the IRS with respect to the underlying preapproved plan, and to the knowledge of Company, any Company Subsidiary or ERISA Affiliate, no fact or event has occurred since the date of such determination, opinion or advisory letter or letters from the IRS that would reasonably be expected to result in the revocation of the qualified status of any such Plan or the exempt status of any such trust by the IRS.

(h) There has not been any non-exempt prohibited transaction (within the meaning of Section 406 of ERISA or Section 4975 of the Code) nor any reportable events (within the meaning of Section 4043 of ERISA) with respect to any Plan. There have been no acts or omissions by the Company or any ERISA Affiliate that have given or could reasonably be expected to give rise to any material fines, penalties, taxes or related charges under Sections 502 or 4071 of ERISA or Section 511 or Chapter 43 of the Code for which the Company or any ERISA Affiliate may be liable.

(i) All contributions, premiums or payments required to be made with respect to any Plan have been timely made to the extent due or properly accrued on the consolidated financial statements of the Company and the Company Subsidiaries. Neither the Company, any Company Subsidiary nor ERISA Affiliate maintains, administers or has any liability (contingent or otherwise) with respect to a defined benefit plan that is subject to Section 412 of the Code or Title IV of ERISA or other applicable Law. Each Plan required to be funded by applicable Law or the terms of such Plan has been, is and will be materially funded as of the Closing, subject to and to the extent required by applicable Law or the relevant Plan.

(j) The Company, any Company Subsidiary and each of its ERISA Affiliates has each complied in all material respects with the applicable notice and continuation coverage requirements, and all other requirements, of Section 4980B of the Code and Parts 6 and 7 of Title I of ERISA, and the regulations thereunder, with respect to each Plan that is, or was during any taxable year for which the statute of limitations on the assessment of federal income taxes remains open, by consent or otherwise, a group health plan within the meaning of Section 5000(b)(1) of the Code.

(k) The Company, any Company Subsidiary and each of its ERISA Affiliates, and each Plan that is a “group health plan” as defined in Section 733(a)(1) of ERISA (each, a “Health Plan”) is in material compliance with the applicable provisions of the Patient Protection and Affordable Care Act of 2010, as amended (“PPACA”), and no event has occurred, and no condition or circumstance exists, that would reasonably be expected to subject the Company, any Company Subsidiary or any ERISA Affiliate or any Health Plan to any liability for penalties or excise taxes under Code Section 4980D or 4980H or any other provision of the PPACA.

(l) Each Plan that constitutes a nonqualified deferred compensation plan subject to Section 409A of the Code has been documented, administered and operated in compliance with the provisions of Section 409A

of the Code and the Treasury Regulations thereunder, and no additional Tax under Section 409A(a)(1)(B) of the Code has been or would reasonably be expected to be incurred by a participant in any such Plan.

(m) The Company does not have any agreements that provide for, nor has it made any promises to “gross up” any person for any taxes, including any taxes pursuant to Section 409A or Section 4999 of the Code.

(n) Neither the Company, any Company Subsidiary nor any ERISA Affiliate has ever maintained, established, sponsored, participated in, or contributed to, any plan that has been adopted or maintained, whether formally or informally, for the benefit of service providers who primarily perform services outside of the United States of America.

#### **SECTION 4.12 Labor and Employment Matters.**

(a) Schedule 4.12(a) of the Company Disclosure Schedule sets forth a true, correct and complete list of all employees of the Company and any Company Subsidiary as of the date hereof, including any employee who is on a leave of absence of any nature, authorized or unauthorized, and sets forth for each such individual the following: (i) title or position (including whether full or part time); (ii) location and employing entity; (iii) hire date; (iv) exemption treatment by the Company under applicable wage and hour Laws; (v) current annual base compensation rate (or, for hourly employees, the applicable hourly compensation rate); (vi) commission, transaction bonus, retention bonus, other bonus or other incentive based compensation; (vii) average weekly work hours, and (viii) accrued paid time off. All employees of the Company have acknowledged their status as employees at will. Except as set forth on Schedule 4.12(a) of the Company Disclosure Schedule, as of the date hereof, all compensation, including wages, commissions and bonuses and any termination indemnities, due and payable to all current and former employees of the Company and any Company Subsidiary for services performed on or prior to the date hereof have been paid in full (or accrued in full in the Company’s financial statements).

(b) (i) There are no Actions pending or, to the knowledge of the Company, threatened against the Company or any Company Subsidiary by any of their respective current or former employees or other service providers, which Actions would be material to the Company and the Company Subsidiaries, taken as a whole; (ii) neither the Company nor any Company Subsidiary is, nor have the Company or any Company Subsidiary been, for the past five (5) years, a party to, bound by, or negotiating any collective bargaining agreement or other contract with a union, works council or labor organization applicable to persons employed by the Company or any Company Subsidiary, nor, to the knowledge of the Company, are there any activities or proceedings of any labor union to organize any such employees; (iii) there are no unfair labor practice complaints threatened or pending against the Company or any Company Subsidiary before the National Labor Relations Board or similar state or foreign labor relations agency; and (iv) there is not now, nor, to the knowledge of the Company, has there been, in the past five (5) years, any threat of any strike, slowdown, work stoppage, lockout, concerted refusal to work overtime or other similar labor disruption or dispute with respect to the Company or any Company Subsidiary.

(c) The Company and the Company Subsidiaries are and, for the past four (4) years, have been in material compliance with all applicable Laws and contracts relating to employment, employment practices, employment discrimination, harassment and retaliation, terms and conditions of employment, termination and discharge, mass layoffs and plant closings (including the Worker Adjustment and Retraining Notification Act of 1988, as amended, and any similar state, local or foreign Law (collectively, the “WARN Act”), reasonable accommodation, disability rights or benefits, immigration, hiring, meal and rest breaks, overtime, payroll documents and wage statements, pay equity, affirmative action obligations, proper classification of employees and other service providers, workers’ compensation, family and medical leave, sick leave, occupational safety and health requirements (including any federal, state or local Laws and orders by Governmental Authorities related to COVID-19), wages, hours, collective bargaining and the payment and withholding of taxes and other sums and social contributions as required by the appropriate Governmental Authority. Neither the Company or any Company Subsidiary are liable in any material

amount for any arrears of wages, taxes, social contributions, penalties or other sums for failure to comply with any of the foregoing Laws. The Company and each of the Company Subsidiaries are in material compliance with the requirements of the Immigration Reform Control Act of 1986. All current and former employees of the Company and the Company Subsidiaries, as applicable, have at all times been properly classified as exempt or non-exempt under the Fair Labor Standards Act and applicable state wage and hour Laws, and all current and former independent contractors and temporary workers of the Company or the Company Subsidiaries, as applicable, have been properly classified and treated as such. Except as would not be material to the Company and the Company Subsidiaries taken as a whole, there have been no misclassification claims filed or, to the knowledge of the Company, threatened against the Company or any Company Subsidiary by any current or former employees, independent contractors or temporary workers or by any Governmental Authority.

(d) (i) The Company and each Company Subsidiary have complied, and are in compliance in all material respects with, have not materially violated, and are not in material violation of, and have not received any notices of material non-compliance or violation or alleged material non-compliance or violation with respect to, any Law relating or pertaining to COVID-19; and (ii) the Company and each Company Subsidiary have taken reasonable steps to minimize potential workplace exposure in light of COVID-19, and the Company has delivered to GigCapital5 accurate and complete copies of all Company policies implemented in relation to COVID-19.

(e) Except as set forth on Schedule 4.12(e) of the Company Disclosure Schedule, there has been (i) no layoff, plant closing, termination, redundancy or any other forms of employment losses in the six-month period prior to Closing that would trigger the obligations of the Company or any Company Subsidiary under the WARN Act and (ii) no termination of employment (including by resignation or otherwise) of any key employees in the six-month period prior to Closing.

(f) No officer of the Company or the Company Subsidiaries has given written notice to the Company or the Company Subsidiaries as of the date of this Agreement that such employee intends to terminate his or her employment.

(g) In the past five (5) years, there have been no allegations of sexual harassment or misconduct involving any current or former director, officer, employee or independent contractor of the Company or any Company Subsidiary, and neither the Company nor any Company Subsidiary has entered into any settlement agreements related to allegations of sexual harassment or sexual misconduct by any current or former director, officer, employee or independent contractor of the Company or any Company Subsidiary.

(h) Schedule 4.12(h) of the Company Disclosure Schedule sets forth, as of the date hereof, a true, correct and complete anonymized list using Company identification instead of names of all of the independent contractors, consultants, temporary employees, leased employees and other agents employed or used by the Company or any Company Subsidiary and classified by the Company or any Company Subsidiary as other than employees, or compensated other than through wages paid by the Company or any subsidiary through such entity's payroll department (each, a "Contingent Worker") of the Company and each Company Subsidiary and for each, (a) such individual's compensation arrangement (including whether paid on an hourly or project basis), (b) such individual's initial date of engagement, (c) a description of services provided, (d) identification of the staffing company or agency through which they are engaged (if applicable), (e) location where services are provided, (f) average hours worked per week, or alternatively, the total hours worked by such Contingent Worker, and (g) whether engaged as an individual or through an entity. As of the date hereof, all compensation payable to all Contingent Workers of the Company and its Company Subsidiaries for services performed on or before the date of this Agreement has been paid in full and there are no outstanding agreements, understandings, or commitments of the Company regarding any compensation.

#### **SECTION 4.13 Real Property; Title to Assets.**

(a) There is no Owned Real Property.

(b) Schedule 4.13(b) of the Company Disclosure Schedule lists the street address of each parcel of Leased Real Property, and sets forth a list of each lease, sublease, and license pursuant to which the Company or any Company Subsidiary leases, subleases or licenses any real property (each, a “Lease”), with the name of the lessor and the date of the Lease in connection therewith and each material amendment to any of the foregoing (collectively, the “Lease Documents”). True, correct, and complete copies of all Lease Documents have been made available to GigCapital5. Except as otherwise set forth in Schedule 4.13(b) of the Company Disclosure Schedule, (i) there are no leases, subleases, concessions, or other contracts granting to, and neither the Company nor any Company Subsidiary is a party to any lease, sublease, concession or other contract granting to the Company or Company Subsidiaries, the right to use or occupy any real property, and (ii) all such Leases are in full force and effect, are valid and enforceable in accordance with their respective terms, subject to the Remedies Exceptions, and there is not, under any of such Leases, any existing default or event of default (or event which, with notice or lapse of time, or both, would constitute a default) by the Company or any Company Subsidiary or, to the Company’s knowledge, by the other party(ies) to such Leases, except as would not, individually or in the aggregate, allow the landlord under such Lease to terminate such Lease or otherwise be material to the Company and the Company Subsidiaries, taken as a whole. Neither the Company nor any Company Subsidiary, has leased, subleased, sublicensed or otherwise granted to any person any right to use, occupy or possess any portion of the Leased Real Property.

(c) There are no contractual or legal restrictions that preclude or restrict the ability of the Company or Company Subsidiary to use any Leased Real Property by such party for the purposes for which it is currently being used. There are no latent defects or adverse physical conditions affecting the Leased Real Property, and improvements thereon, other than those that would not have a Company Material Adverse Effect.

(d) Each of the Company and the Company Subsidiaries has legal and valid title to, or, in the case of Leased Real Property and assets, valid leasehold or subleasehold interests in, all of its properties and assets, tangible and intangible, real, personal and mixed, used or held for use in its business, free and clear of all Liens other than Permitted Liens, except as would not, individually or in the aggregate, be material to the Company and the Company Subsidiaries, taken as a whole.

#### **SECTION 4.14 Intellectual Property.**

(a) Schedule 4.14(a) of the Company Disclosure Schedule contains a true, correct and complete list of all of the following: (i) Registered Company IP (showing in each, as applicable, the filing date, date of issuance, expiration date and registration or application number, and registrar); and (ii) all material unregistered trademarks used as names for Company Products, owned by the Company or used by the Company in connection with the Company’s business. The Company has delivered to GigCapital5 correct and complete copies of all registrations and applications for Registered Company IP, as amended to date, with all correspondence and file wrapper materials related thereto.

(b) The Company or one of the Company Subsidiaries solely and exclusively owns and possesses, free and clear of all Liens (other than Permitted Liens), all right, title and interest in and to the Company-Owned IP and all Company Software. The consummation of the transactions contemplated hereby will not result in (a) any loss or impairment of the Company’s or any Company Subsidiary’s right to own or use any Company IP, including any loss of exclusivity or decrease in license scope, (b) any increase in royalty or other payment obligations of the Company or of any Company Subsidiary, (c) the grant of any new license, or an increase in the scope of any license granted by the Company or any Company Subsidiary, or (d) any other change in the terms or conditions applicable to the Company IP immediately prior to the Closing. All Company-Owned IP is subsisting and, excluding any Registered Company IP that consists solely of an application for registration, is valid and enforceable. All Registered Company IP is currently in compliance with all applicable legal requirements.

(c) The Company and each of its applicable Company Subsidiaries have taken reasonable actions to maintain, protect and enforce Intellectual Property rights in and to all Company-Owned IP, all Company



Software, all Company Products, and all Company Services, including the secrecy, confidentiality and value of its Trade Secrets and other Confidential Information. Neither the Company nor any Company Subsidiaries have disclosed any trade secrets or other Confidential Information that is material to the business of the Company and/or any applicable Company Subsidiaries to any other person other than pursuant to a written confidentiality agreement under which such other person agrees to maintain the confidentiality and protect such trade secrets and Confidential Information.

(d) (i) There have been no claims filed and served, or threatened in writing (including email), against the Company or any Company Subsidiary in any forum, by any person (A) contesting the validity, use, ownership, enforceability, patentability or registrability of any of the Company IP, or (B) alleging any infringement, violation or misappropriation of, or other conflict with, any Intellectual Property rights of other persons (including any material demands or unsolicited offers to license any Intellectual Property rights from any other person); (ii) the operation of the Company Business (including the use, development, manufacture, marketing, license, sale, distribution or furnishing of any Company Software, Company Products, and/or Company Services) has not and does not infringe, misappropriate or violate, any Intellectual Property rights of other persons or constitute, unfair competition or trade practices under the Laws of any applicable jurisdiction; (iii) no person, including any employee or former employee of Company or any Company Subsidiary, has infringed, misappropriated or violated any of the Company-Owned IP; (iv) none of the Company-Owned IP is subject to any proceeding, or outstanding order, agreement, settlement or stipulation restricting in any manner the use, enforcement, development, manufacture, marketing, licensing, sale, distribution, furnishing or disposition by the Company or any of the Company Subsidiaries of any Company-Owned IP; and (v) neither the Company nor any of the Company Subsidiaries has received any formal written opinions of counsel regarding any of the foregoing.

(e) All persons who have contributed, developed or conceived any Company-Owned IP (i) for or on behalf of Company or any of the Company Subsidiaries, or (ii) in the course of and related to his, her, or its relationship with the Company or the applicable Company Subsidiary (in each case a "Contribution") have executed valid, written agreements with the Company or one of the Company Subsidiaries pursuant to which such persons have presently and irrevocably assigned to the Company or the applicable Company Subsidiary all of their entire right, title, and interest in and to any Contribution and, to the extent applicable, waived moral rights without further future consideration or any restrictions or obligations whatsoever, including on the use or other disposition or ownership of such Intellectual Property. All such assignments are enforceable and fully effective to vest sole and exclusive ownership of any and all Contributions in the Company or the applicable Company Subsidiary and were made in compliance with all requirements of applicable Law, including if required, a timely agreement formalizing such transfer, payment of remuneration, and registration with the applicable Governmental Authority. To the knowledge of the Company, no current or former officer, employee, or Contingent Worker of the Company or any of the Company Subsidiaries: (A) is, nor has been, in violation of any term or covenant of any agreement (including, without limitation, any employment or settlement agreement or stipulation) with any other person, or any order or judgment of any court, arbitrator or other Governmental Authority, by virtue of such employee or Contingent Worker being employed by, performing services for, or developing Intellectual Property used by, the Company or any Company Subsidiary, or is, nor has been while such employee or Contingent Worker has been employed by, performed services for, or developed Intellectual Property used by, the Company or any Company Subsidiary, using trade secrets or proprietary information of others without permission; (B) has any right, license, claim or interest whatsoever in or with respect to any Company-Owned IP; or (C) has developed any Intellectual Property for the Company or any of the Company Subsidiaries that is subject to any agreement under which such employee or Contingent Worker has assigned or otherwise granted to any third party any rights in or to such Intellectual Property.

(f) Neither the Company nor any of the Company Subsidiaries or, any other person is in material breach or in material default of any agreement required to be disclosed in Schedules 4.14(f) or 4.14(k) of the Company Disclosure Schedule.

(g) Open Source.

(i) All use, licensing, providing, delivery and distribution of Company Software, Company Products, Company Services and Open Source Materials by or through the Company and each of the Company Subsidiaries is in compliance in all material respects with all Open Source Licenses applicable thereto, including all copyright notice and attribution requirements.

(ii) The Company has not incorporated, embedded, bundled, used, distributed, linked, or otherwise provided any Open Source Materials into, with, or in connection with any Company Software, Company Products and/or Company Services in a manner that requires any Company Software or other Company-Owned IP, or any portion thereof, to be subject to Copyleft Licenses, or requires the Company, any Company Subsidiary, to grant any Patent license or other Patent rights with respect to Company-Owned IP.

(h) The Company and/or one of the Company Subsidiaries owns, leases, licenses, or otherwise has the legal right to use all Business Systems, and such Business Systems are sufficient for the immediate and anticipated future needs of the Company Business. In the past three (3) years, there has not been a material failure with respect to any of the Business Systems that has not been remedied. The Company and each of the Company Subsidiaries maintain commercially reasonable business continuity and disaster recovery plans.

(i) The Company and each of the Company Subsidiaries currently have complied with (i) all applicable federal, state, local and foreign laws, rules and regulations pertaining to data protection, cyber security, recording, surveillance, biometrics, location, artificial intelligence, machine learning, automated decision making, and e-commerce, including without limitation, the Regulation (EU) 2016/279 of the European Parliament and of the Council (General Data Protection Regulation) and any European Union member state law implementing said regulation, and HIPAA, and the Health Information Technology for Economic and Clinical Health Act (“HITECH”), the Fair Credit Reporting Act (including the Fair and Accurate Credit Transactions Act of 2003) and other similar laws, in each case, as amended and the rules or regulations implemented thereunder, and the Processing of Personal Data (“Privacy Laws”), (ii) any applicable privacy, data protection, security and other policies and procedures of the Company and/or the Company Subsidiaries, respectively, required under HIPAA or other Privacy Laws, concerning the Processing of Personal Information and a comprehensive information security program that includes appropriate written information security policies, (iii) applicable industry standards, guidelines, and self-regulatory programs regarding Personal Information to which the Company or any Company Subsidiary is bound including the Payment Card Industry Data Security Standard, and (iv) all contractual commitments that the Company or any Company Subsidiaries have entered into or to which the Company or the Company Subsidiaries are bound with respect to the privacy, data protection, Processing and/or security of Personal Information (collectively, (i)-(iv) the “Privacy Requirements”). The Company has delivered to Merger Sub accurate and complete copies of all Privacy Requirements. Neither the execution, delivery, or performance of this Agreement, nor the consummation of any of the transactions contemplated under this Agreement, nor the Company’s Processing of Personal Information will violate any of the Privacy Requirements.

(j) The Company and the Company Subsidiaries have licensed, obtained and/or purchased all Personal Information in accordance with Privacy Requirements and required any Persons providing Personal Information to the Company and the Company Subsidiaries to comply with applicable Privacy Requirements. The Company and the Company Subsidiaries have provided notifications to, obtained consent from, and honored any opt-out or other privacy request from persons regarding the Processing of Personal Information where such action is required by Privacy Requirements including in connection with (i) the use of cookies, devices or browsers, (ii) the use of session replay technology, cross-device tracking, cross context behavioral advertising, location, automated decision making, profiling, artificial intelligence or biometrics, or (iii) any user, device, account, or other tracking technology or similar technology. There has been no interception, disclosure of, recording of, improper transfer of, provision of access to, or other Processing of electronic communications or other information in violation of any Privacy Requirements by or for the Company.

(k) The Company and the Company Subsidiaries have not (i) received direct written communication from any site, application, device, or platform (“Property”) owner or operator that Company’s or Company Subsidiaries’ access to the Property is unauthorized; (ii) entered into an agreement with any owner or operator prohibiting scraping or other activity; (iii) accessed any information through circumventing a password requirement or similar technological barrier; or (iv) scraped any data from a Property that prohibits such activity through terms or Laws.

(l) Except as provided in Schedule 4.14(l), the Company and the Company Subsidiaries do not sell, share, rent, or otherwise make available any Personal Information to a person for the persons’ own use, and do not collect biometric data, biometric information or location data

(m) The Company and the Company Subsidiaries have each implemented and maintained, and to the Company’s knowledge, have required third parties that process material Personal Information on their behalf to implement and maintain, a written information security program and commercially reasonable physical, technical and administrative security safeguards (including, without limitation, implementing, maintaining, and monitoring compliance with government-issued or industry standard measures) designed to protect in all material respects the security and integrity of its Personal Information, including conducting regular vulnerability scans, risk assessments and remediation activities and implementing industry standard procedures preventing unauthorized access, modification, disclosure, misuse, loss, or unavailability of the foregoing and/or the introduction of Disabling Devices. The Company and the Company Subsidiaries have remediated all critical and high findings. Neither the Company nor any of the Company Subsidiaries has (x) experienced any data or security breaches or unauthorized Processing or unavailability of Personal Information including those that were required to be reported under applicable Privacy Requirements; (y) received a demand for or paid any ransomware or experienced a successful phishing, social engineering, or business email compromise incident ((x) or (y), a “Security Incident”). The Company has not provided any notices to, nor has it been legally required to provide any such notices, to any Person as a result of any such Security Incident. Neither the Company nor any Company Subsidiaries has been subject to nor received written notice of any audits, proceedings or investigations by any Governmental Authority or any person, or received any written claims or complaints alleging the violation of any applicable Privacy Requirements. The Company has not been obligated to make any notification of a breach of Protected Health Information as defined under HIPAA or other Personal Information to individuals, the media, the Secretary of the U.S. Department of Health and Human Services, any state attorney general or any other governmental body pursuant to HIPAA, HITECH or any applicable Law.

(n) The Company is, and at all times has been in compliance with all U.S. federal and state laws and regulations pertaining to sales, marketing, and electronic communications, including, without limitation, the CAN-SPAM Act, the Telephone Consumer Protection Act, and the Telemarketing Sales Rule.

(o) The Company is, and at all times has been in compliance with relevant requirements of HIPAA and HITECH.

(i) The Company has implemented reasonable administrative, physical and technical safeguards to ensure the confidentiality, integrity, and security of electronic Protected Health Information in compliance with the HIPAA Security Rule as set forth in 45 C.F.R. Part 160 and subparts A and C of 45 C.F.R. Part 164.

(ii) The Company has conducted risk assessments in accordance with 45 C.F.R. § 164.308(a)(1)(ii)(A) and has implemented safeguards to reduce all moderate to high-risk findings to a reasonable level.

(iii) The Company has current and valid Business Associate Agreements with each (i) Covered Entity for which the Company provides functions or activities that render the Company a Business Associate of such Covered Entity, and (ii) Business Associate and each Subcontractor of the Company that is a Business Associate of the Company. The Company has not breached any material terms of any Business Associate Agreement to which it is a party. To the Company’s knowledge, no Covered Entity,

Business Associate or Subcontractor has breached any material term of any Business Associate Agreement to which the Company is a party. For purposes of this subsection, the terms "Covered Entity," "Business Associate," and "Subcontractor" shall have the meanings given such terms under HIPAA and HITECH.

(p) The Company and/or one of the Company Subsidiaries (i) exclusively owns and possesses all right, title and interest in and to the Business Data free and clear of any restrictions of any nature or (ii) have all rights to use, exploit, publish, reproduce, process, distribute, license, sell, and create derivative works of the Business Data, in whole or in part, in the manner in which the Company and the Company Subsidiaries receive and use such Business Data prior to the Closing Date.

(q) All current officers, management employees, technical and professional employees, and Contingent Workers of the Company and the Company Subsidiaries are under obligation to the Company and the Company Subsidiaries to maintain in confidence all confidential or proprietary information acquired by them in the course of their employment and to assign to the Company and the Company Subsidiaries all Intellectual Property made by them within the scope of their employment during such employment. To the Company's knowledge, no past or current officers, management employees, technical or professional employees, and Contingent Workers of the Company or any Company Subsidiaries are in breach of any such obligations to the Company or any of the Company Subsidiaries.

(r) Neither this Agreement nor any transactions contemplated by this Agreement will result in the following under or pursuant to any contracts to which the Company or any of the Company Subsidiaries is a party, or by which any assets or properties of the Company or of any of the Company Subsidiaries are bound: any person being granted rights or access to, or the placement in or release from escrow of, any Company Software source code or other technology.

(s) Schedule 4.14(s) of the Company Disclosure Schedule sets forth a true, correct and complete list of all contracts pursuant to which any person (i) has been provided any Company Software in source code format, or (ii) has obtained or may obtain rights to receive any Company Software in source code form through or from the Company or any Company Subsidiary, any escrow agent or any other person. The Company has not disclosed or delivered to any escrow agent or any other person any source code for any Company Software, and no person has any right to obtain access to or use any such source code.

(t) No Governmental Authority, and no other national, multi-national, bi-national or international governmental organization, governmental research center, university, college, other educational institution, foundation, research center or non-profit institution provided or provides funding, facilities, personnel, Intellectual Property, technology, research, equipment, or other resources for the invention, creation, development or registration of any Company-Owned IP or has any rights to any Company-Owned IP.

(u) The Company has not received any opinion of counsel that a third party has infringed, misappropriated, misused or violated, or is infringing, misappropriating, misusing or violating, any Company-Owned IP, Company Software, Company Products, and/or Company Services. The Company has not made any claim against any person alleging any infringement, misappropriation, misuse or violation of any Company-Owned IP, Company Software, Company Products, and/or Company Services.

(v) Neither the Company nor any Company Subsidiary has received any written notice or request to indemnify, defend or hold harmless any person with respect to any claim of infringement, misappropriation, misuse or violation of any Intellectual Property.

(w) Schedule 4.14(w) of the Company Disclosure Schedule sets forth a true, correct and complete list of all Outbound IP Licenses.

(x) Schedule 4.14(x) of the Company Disclosure Schedule sets forth a true, correct and complete list of all Inbound IP Licenses. The Company has paid, in full, all mandatory compensation the Company is required to pay to employees, contractors and consultants of the Company in relation to all Company-Owned IP, and neither this Agreement nor any transactions contemplated by this Agreement will result in

any further amounts being payable to any current or former employees, contractors or consultants of the Company in relation to any Company-Owned IP.

(y) The Company has not made, directly or indirectly, any commitments, promises, submissions, suggestions, statements or declarations to any standards-setting bodies, industry groups or other similar organizations (“Standards Organizations”) (including any commitments, promises, submissions, suggestions, statements or declarations) that would obligate the Company or any Company Subsidiary to grant licenses to any person or otherwise impair or limit the Company’s or any of the Company’s Subsidiaries’ control of any Company-Owned IP.

(z) Schedule 4.14(z) of the Company Disclosure Schedule sets forth a true and complete list of (i) all customers of the Company and of the Company Subsidiaries, on a consolidated basis, determined by Dollar volume of sales, for each of the years ended December 31, 2020 and 2021 and for the period from January 1, 2022 to September 30, 2022 (each, a “Top Customer”) and (ii) the twenty (20) largest suppliers of or vendors to the Company, including, without limitation, any professional employer organization, on a consolidated basis determined by Dollar volume of expenditures, for each of the years ended December 31, 2020 and 2021 and for the period from January 1, 2022 to September 30, 2022 (each, a “Top Supplier”).

#### **SECTION 4.15 Taxes.**

(a) The Company and each Company Subsidiary: (i) have duly and timely filed (taking into account any extension of time within which to file) all income and other material Tax Returns required to be filed by any of them and all such filed Tax Returns are complete and accurate in all material respects; (ii) have timely paid all material Taxes (whether or not shown on any Tax Return) that they were obligated to pay, except with respect to current Taxes not yet due and payable, Taxes that are being contested in good faith or that are described in clause (a)(v) below; (iii) with respect to all income and other material Tax Returns filed by or with respect to any of them, have not waived any statute of limitations with respect to Taxes or agreed to any extension of time with respect to a Tax assessment or deficiency; (iv) do not have any deficiency, assessment, claim, audit, examination, investigation, litigation or other proceeding in respect of a material amount of Taxes or material Tax matters pending or threatened in writing, for a Tax period which the statute of limitations for assessments remains open; and (v) have provided adequate reserves in accordance with GAAP in the most recent consolidated financial statements of the Company, for any material Taxes of the Company that have not been paid, whether or not shown as being due on any Tax Return, and will not, as of the Closing Date, exceed such reserves as adjusted for the passage of time through the Closing Date in accordance with past custom and practice.

(b) Neither the Company nor any Company Subsidiary is a party to, is bound by or has an obligation under any material Tax sharing agreement, Tax indemnification agreement, Tax allocation agreement or similar contract or arrangement (excluding any agreement, contract, or arrangement the primary purpose of which does not relate to Taxes) or has a potential liability or obligation to any person as a result of or pursuant to any such agreement, contract, arrangement, or commitment other than an agreement, contract, arrangement, or commitment entered into in the ordinary course of business the primary purpose of which does not relate to Taxes.

(c) Neither the Company nor any Company Subsidiary will be required to include any item of income in, or exclude any item of deduction from, taxable income for any taxable period (or portion thereof) ending after the Closing Date as a result of any: (i) change in method of accounting for a taxable period ending on or prior to the Closing Date under Section 481(c) of the Code (or any corresponding or similar provision of state, local or foreign income Tax law); (ii) “closing agreement” as described in Section 7121 of the Code (or any corresponding or similar provision of state, local or foreign income Tax law) executed on or prior to the Closing Date; (iii) installment sale or open transaction made on or prior to the Closing Date; (iv) intercompany transaction or any excess loss account described in Treasury Regulations under Section 1502 of the Code (or any corresponding or similar provision of state, local or foreign income Tax Law) entered into or created on or prior to the Closing Date; or (v) prepaid amount received on or prior to the Closing Date outside the ordinary course of business.

(d) The Company and each Company Subsidiary have withheld and paid to the appropriate Tax authority all material Taxes required to have been withheld and paid in connection with amounts, or benefits under any Plan, paid or owing to any current or former employee, Contingent Worker, creditor, shareholder or other third party and have complied in all material respects with all applicable laws, rules and regulations relating to the payment and withholding of Taxes.

(e) No person holds shares of capital stock of the Company that are non-transferable and subject to a substantial risk of forfeiture within the meaning of Section 83 of the Code with respect to which a valid election under Section 83(b) of the Code has not been timely made.

(f) None of the Company, any Company Subsidiary or any affiliate of the Company has made any payments, or is obligated to make any payments or is a party to any Plan or contract or other benefit that would reasonably be expected to obligate it to make any payments that would not be deductible under Section 280G of the Code or result in the payment of an excise tax by any person under Section 4999 of the Code.

(g) Neither the Company nor any Company Subsidiary has been a member of an affiliated group filing a consolidated, combined, or unitary U.S. federal, state, local or foreign income Tax Return (other than a group of which the Company was the common parent).

(h) Neither the Company nor any Company Subsidiary has any liability for the Taxes of any person (other than the Company and the Company Subsidiaries) under Treasury Regulation Section 1.1502-6 (or any similar provision of state, local or foreign law), as a transferee or successor, by contract (but excluding any contract the primary purpose of which does not relate to taxes), or otherwise.

(i) Neither the Company nor any Company Subsidiary (i) has any request for a ruling in respect of Taxes pending between the Company or any Company Subsidiary, on the one hand, and any Tax authority, on the other hand; or (ii) has entered into any closing agreement, private letter ruling, technical advice memoranda or similar agreements with any Tax authority.

(j) Neither the Company nor any Company Subsidiary has in any year for which the applicable statute of limitations remains open distributed stock of another person, or has had its stock distributed by another person, in a transaction that was purported or intended to be governed in whole or in part by Section 355 or Section 361 of the Code.

(k) The Company is, and has been at all times since its formation, properly classified as a domestic corporation for U.S. federal and applicable state and local income Tax purposes, and each Company Subsidiary is, and has been at all times since its formation, properly classified either as a domestic corporation or a domestic disregarded entity for U.S. federal and applicable state and local income Tax purposes.

(l) Neither the Company nor any Company Subsidiary has filed any amended Tax Return or other claim for a refund as a result of, or in connection with, the carry back of any net operating loss or other attribute to a year prior to the taxable year including the Closing Date under Section 172 of the Code, as amended by Section 2303 of the CARES Act, or any corresponding or similar provision of state, local or non-U.S. Law.

(m) Each of the Company and each Company Subsidiary has (i) properly complied with all legal requirements in order to defer the amount of the employer's share of any "applicable employment taxes" under Section 2302 of the CARES Act (or any similar provision of state, local or non-U.S. Law), (ii) to the extent applicable, properly complied with all legal requirements and duly accounted for any available Tax credits under Sections 7001 through 7005 of the Families First Act and Section 2301 of the CARES Act, (iii) not sought (nor has any Affiliate that would be aggregated with the Company or any Company Subsidiary and treated as one employer for purposes of Section 2301 of the CARES Act sought) a covered loan under paragraph (36) of Section 7(a) of the Small Business Act (15 U.S.C. 636(a)), as added by Section 1102 of the CARES Act, and (iv) not deferred any payroll Tax obligations (including those imposed

by Sections 3101(a) and 3201 of the Code) pursuant to or in connection with the Memorandum on Deferring Payroll Tax Obligations in Light of the Ongoing COVID-19 Disaster, dated August 8, 2020, or any other provision of the CARES Act except as contemplated by clause (i) above.

(n) Neither the Company nor any Company Subsidiary has engaged in or entered into a “reportable transaction” within the meaning of Treasury Regulation Section 1.6011-4(b).

(o) Neither the IRS nor any other Tax authority has asserted in writing or, to the knowledge of the Company or any Company Subsidiary, has threatened to assert against the Company or any Company Subsidiary any deficiency or claim for any Taxes.

(p) Neither the Company nor any Company Subsidiary has received written notice from a non-United States Tax authority that it has a permanent establishment (within the meaning of an applicable Tax treaty) or otherwise has an office or fixed place of business in a country other than the country in which it is organized.

(q) Neither the Company nor any Company Subsidiary has taken, has agreed to take, or intends to take, in each case, any action that could reasonably be expected to prevent or impede the transactions contemplated by this Agreement from qualifying for the Intended Tax Treatment. To the knowledge of the Company, no facts or circumstances exist that could reasonably be expected to prevent or impede the transactions contemplated by this Agreement from qualifying for the Intended Tax Treatment.

(r) There are no Tax liens upon any assets of the Company or any of the Company Subsidiaries except for Permitted Liens.

(s) None of the Company and the Company Subsidiaries has been a United States real property holding corporation within the meaning of Section 897(c)(2) of the Code during the applicable period specified in Section 897(c)(1)(A)(ii) of the Code. None of the Company and its Company Subsidiaries has received written notice from a non-United States taxing authority that it has a permanent establishment (within the meaning of an applicable Tax treaty) or otherwise has an office or fixed place of business in a country other than the country in which it is organized.

**SECTION 4.16 Environmental Matters.** (a) None of the Company nor any of the Company Subsidiaries has materially violated since January 1, 2018 or is in material violation of any Environmental Law or any permit, license or other authorization issued to each of the Company and each Company Subsidiary under applicable Environmental Law (“Environmental Permit”) and all past non-compliance has been resolved without ongoing obligations or costs; (b) there has been no Release of Hazardous Substances at any of the properties or facilities currently, or to the knowledge of the Company, formerly owned, leased or operated by the Company or any Company Subsidiary or at any location or facility where wastes from the business or assets of the Company or the Company Subsidiaries are disposed of or recycled; (c) none of the Company or any of the Company Subsidiaries is, in any material respect, actually, or to the knowledge of the Company, potentially or allegedly liable pursuant to applicable Environmental Laws for any off-site contamination by Hazardous Substances; (d) each of the Company and each Company Subsidiary has all material Environmental Permits required under applicable Environmental Law; (e) all material Environmental Permits are in full force and effect and there are no facts or circumstances that would be reasonably expected to result in the revocation or modification of any material Environmental Permit; (f) none of the Company nor any of the Company Subsidiaries is the subject of any claims, actions or suits relating to Hazardous Substances or arising under Environmental Laws, and to the knowledge of the Company, there are no facts or circumstances that would be reasonably expected to result in any material future claims, liabilities or actions; (g) none of the Company or any of the Company Subsidiaries is subject to any material outstanding order, writ, judgment, injunction, temporary restraining order, stipulation, determination, decree or award of any Governmental Authority under Environmental Laws; (h) no consent, approval or authorization of or registration or filing with any Governmental Authority is required by Environmental Laws or Environmental Permits in connection with the execution, delivery and performance of this Agreement or the consummation of the transactions contemplated by this Agreement; (i) none of the Company or any of the Company Subsidiaries has assumed, undertaken or provided an unexpired indemnity with

respect to any material liability, in each case relating to Hazardous Substances or relating to Environmental Laws; and (j) there neither are nor have been any landfills, disposal areas, aboveground storage tanks or underground storage tanks at any of the Company's currently or formerly owned, leased or operated properties; (k) the Company has made available to GigCapital5 correct and complete copies of all Phase I environmental reports and other environmental sampling and monitoring data, Phase II environmental reports, environmental health and safety audits or inspections, and material documents related to any proceeding or unresolved material liability arising under Environmental Laws relating to the Company or any of the Company Subsidiaries or any other current or former property, facility or operating location.

**SECTION 4.17 Material Contracts.**

(a) Schedule 4.17(a) of the Company Disclosure Schedule lists, as of the date of this Agreement, the following types of currently active contracts and agreements to which the Company or any Company Subsidiary is a party (such contracts and agreements as are required to be set forth Schedule 4.17(a) of the Company Disclosure Schedule along with any Plan listed on Schedule 4.11(a) of the Company Disclosure Schedule being the "Material Contracts"):

- (i) each contract with each Top Customer, and all other contracts with consideration paid or payable to the Company or any of the Company Subsidiaries of more than \$50,000, in the aggregate, over the past 12 months;
- (ii) each contract with each Top Supplier, and all other contracts involving expenditures paid or payable by the Company or any Company Subsidiary of more than \$50,000, in the aggregate, over the past 12 months;
- (iii) all broker, distributor, dealer, manufacturer's representative, franchise, agency, sales promotion, market research, marketing consulting and advertising contracts and agreements to which the Company or any Company Subsidiary is a party that require annual payments of \$25,000 or more by the Company or any Company Subsidiary;
- (iv) all (x) management and employment contracts (excluding at-will contracts for employment or at-will offer letters that do not contain any severance or change of control provisions) and (y) contracts with Contingent Workers, including any contracts involving the payment of royalties or other amounts calculated based upon the revenues or income of the Company or any Company Subsidiary or income or revenues related to any Product of the Company or any Company Subsidiary to which the Company or any Company Subsidiary is a party;
- (v) all collective bargaining agreements or other contracts with any labor union;
- (vi) all contracts and agreements evidencing indebtedness for borrowed money with a principal amount greater than \$25,000, and any pledge agreements, security agreements or other collateral agreements in which the Company or any Company Subsidiary granted to any person a security interest in or lien on any of the property or assets of the Company or any Company Subsidiary;
- (vii) all partnership agreements or other joint venture agreements, or any contract involving a distributor, reseller, sales representative, marketing, or advertising arrangement in an amount greater than \$25,000;
- (viii) all contracts relating to the settlement of any material internal complaint, grievance, claim, investigation, or other dispute with the Company or any of its Company Subsidiaries in an amount greater than \$25,000;
- (ix) all contracts and agreements with any Governmental Authority to which the Company or any Company Subsidiary is a party, other than any Company Permits;
- (x) all contracts and agreements that limit, or purport to limit, the ability of the Company or any Company Subsidiary to compete in any line of business or with any person or entity or in any



geographic area or during any period of time, excluding customary non-solicitation and non-hire provisions, and customary confidentiality agreements and agreements that contain customary confidentiality clauses;

(xi) all contracts or arrangements that result in any person or entity holding a power of attorney from the Company or any Company Subsidiary that relates to the Company, any Company Subsidiary or their respective businesses;

(xii) all leases or master leases of personal property reasonably likely to result in annual payments of \$25,000 or more in a 12-month period;

(xiii) each Outbound IP License;

(xiv) each Inbound IP License;

(xv) each Outbound IP License that includes any grant by the Company or any Company Subsidiary to any person of any express license, right or covenant not to sue with respect to any Patents, other than a nonexclusive license granted incidental to a sale of Company Products, license of Company Software, or provision of Company Services.

(xvi) any contract with any Governmental Authority required to be disclosed in Schedule 4.14(t) of the Company Disclosure Schedule;

(xvii) any contract that grants any (A) exclusive license, supply, distribution or other rights, (B) “most favored nation” rights, (C) rights of first refusal, rights of first negotiation or similar rights or (D) exclusive rights to purchase, license or receive any Company Product, Company Software and/or Company Service;

(xviii) any contract providing for any minimum or guaranteed payments by the Company to any Person;

(xix) any contract that contains indemnification obligations of the Company in excess of \$250,000 or pursuant to which the Company may reasonably incur liability in excess of \$250,000;

(xx) any contract that requires a consent (including any assignment consent) to or otherwise contains a provision relating to a “change of control”, or that would prohibit or delay the consummation of the transactions contemplated by this Agreement; and

(xxi) all agreements or instruments guarantying the debts or other obligations of any person.

(b) (i) Each Material Contract is a legal, valid and binding obligation of the Company or the Company Subsidiaries and, to the knowledge of the Company, the other parties thereto, subject to the Remedies Exceptions, and neither the Company nor any Company Subsidiary is in material breach or violation of, or material default under, any Material Contract nor has any Material Contract been canceled by the other party; (ii) to the Company’s knowledge, no other party is in material breach or violation of, or material default under, any Material Contract; and (iii) the Company and the Company Subsidiaries have not received any written, or to the knowledge of the Company, oral claim of default under any such Material Contract. The Company has furnished or made available to GigCapital5 true and complete copies of all Material Contracts in effect as of the date of this Agreement, including amendments thereto that are material in nature.

#### **SECTION 4.18 International Trade Laws.**

(a) The Company and the Company Subsidiaries are, and have been for the past five years, in compliance in all material respects with all International Trade Laws applicable to them, except where the failure to be in compliance would not reasonably be expected to have, individually or in the aggregate, a Company Material Adverse Effect. Without limiting the foregoing: (i) the Company and the Company Subsidiaries have obtained all material export and import licenses and other approvals required for their

respective imports and exports of products, software and technologies required by any applicable International Trade Laws, and all such approvals and licenses are in full force and effect; (ii) the Company and the Company Subsidiaries are in material compliance with the terms of such applicable export and import licenses or other approvals; (iii) there are no claims pending or to the knowledge of the Company, threatened in writing against any Company or Company Subsidiaries with respect to such export and import licenses or other approvals, except with respect to clauses (i), (ii) and (iii) does not constitute a Company Material Adverse Effect; and (iv) the Company and the Company Subsidiaries have processes in place to ensure that any imported merchandise into the United States is properly declared, marked and labeled in accordance with all U.S. Laws at the time of importation.

(b) The Company and the Company Subsidiaries have not, to its knowledge,

(i) exported, re-exported, transferred, licensed, or brokered the sale or license of any goods, software, services, technology, or technical data to any destination to which, or individual for whom, a license or other authorization is required under the International Trade Laws;

(ii) exported, re-exported, licensed, or transferred any goods, software, services, technology, or technical data to, on behalf of, or for the benefit of any sanctioned person or entity, or person or entity identified on any restricted party lists maintained by the U.S. Government, including the Specially Designated Nationals and Blocked Persons List, and Foreign Sanctions Evaders List, maintained by Office of Foreign Assets Control of the U.S. Treasury Department (“OFAC”); and the Denied Persons List, Entity List, Military End User List, or Unverified List, maintained by the U.S. Department of Commerce’s Bureau of Industry and Security;

(iii) exported, re-exported, licensed, or transferred any goods, software, services, technology, or technical data that have been or will be (A) used for any purposes associated with nuclear activities, missiles, chemical or biological weapons, military, military-intelligence or terrorist activities, or (B) used, transshipped, or diverted contrary to applicable International Trade Laws;

(iv) exported, re-exported, transferred, licensed, or imported any goods, software, services, technology, or technical data to or from Burma/Myanmar, Cuba, Crimea, Iran, North Korea, Sudan, Syria or Venezuela during a time at which such country or region and/or its government was subject to U.S. comprehensive trade embargoes under OFAC regulations, the Export Administration Regulations, or any other applicable statute, regulation or executive order;

(v) manufactured, exported or brokered any defense article or defense service as defined in the International Traffic in Arms Regulations, including within the United States and without regard to whether such defense article or defense service was subsequently exported, without the Company or Company Subsidiaries being registered and in good standing with the Directorate of Defense Trade Controls, U.S. Department of State; or

(vi) received from any governmental authority or any other person any notice, inquiry, or internal or external allegation, or made any voluntary or involuntary disclosure to a governmental authority concerning any actual or potential violation or wrongdoing related to International Trade Laws.

(c) Except as would constitute a Company Material Adverse Effect, neither the Company nor any Company Subsidiary nor any director of or officer of any of the Company or any Company Subsidiary or, to the Company’s knowledge (as defined in the relevant International Trade Laws), any other representative or agent acting on behalf of the Company or any Company Subsidiary is currently identified on the Specially Designated Nationals List or otherwise currently subject to any U.S. sanctions administered by OFAC. The Company and the Company Subsidiaries have not, directly or indirectly in the last five years, used any funds, or loaned, contributed or otherwise made available such funds to any Company Subsidiary, joint venture partner or other person, in connection with any transactions, sales or operations in violation of U.S. sanctions administered by OFAC or for the purpose of unlawfully financing the activities of any person currently subject to, or otherwise in violation of, any U.S. sanctions administered by OFAC.

**SECTION 4.19 Insurance.**

(a) Schedule 4.19(a) of the Company Disclosure Schedule sets forth, with respect to each insurance policy and bonds under which the Company or any Company Subsidiary is an insured, a named insured or otherwise the principal beneficiary of coverage as of the date of this Agreement (the "Insurance Policies"). True, correct and complete copies of such Insurance Policies have previously been made available to GigCapital5 or its Representatives.

(b) With respect to each such insurance of the Insurance Policies: (i) the policy is legal, valid, binding and enforceable in accordance with its terms (subject to the Remedies Exceptions) and, except for policies that have expired under their terms in the ordinary course, is in full force and effect; (ii) neither the Company nor any Company Subsidiary is in breach or default (including any such breach or default with respect to the payment of premiums or the giving of notice), and no event has occurred which, with notice or the lapse of time, would constitute such a breach or default, or permit termination or modification, under the policy; (iii) to the knowledge of the Company, no insurer on the policy has been declared insolvent or placed in receivership, conservatorship or liquidation; (iv) no insurer has indicated in writing or, to the knowledge of the Company otherwise, that it will be cancelling or reducing coverage; (v) all premiums and other charges due have been paid; and (vi) no coverage is on an audited, retrospective, or similar premium basis.

(c) All occurrences, circumstances, and claims have been noticed under applicable insurance policies or bonds that would cover such matters or losses arising from them. With regard to any noticed occurrence, circumstance, or claim that relates to an ongoing or potentially ongoing matter, no insurer has denied or questioned coverage.

**SECTION 4.20 Board Approval: Vote Required.** The Company Board, by resolutions duly adopted by unanimous vote of those voting at a meeting duly called and held and not subsequently rescinded or modified in any way, or by unanimous written consent, has duly (a) determined that this Agreement and the Merger are fair to and in the best interests of the Company and its stockholders, (b) approved this Agreement and the Merger and declared their advisability, and (c) recommended that the stockholders of the Company approve and adopt this Agreement and approve the Merger and directed that this Agreement and the Transactions (including the Merger) be submitted for consideration by the Company's stockholders. The Requisite Approval (the "Company Stockholder Approval") is the only vote of the holders of any class or series of capital stock of the Company necessary to adopt this Agreement and approve the Transactions. The Written Consent, if executed and delivered, would qualify as the Company Stockholder Approval and no additional approval, or vote from any holders of any class or series of capital stock of the Company would then be necessary to adopt this Agreement and approve the Transactions.

**SECTION 4.21 Compliance with Anti-Corruption Laws.**

(a) The Company and the Company Subsidiaries are, and for the last six (6) years have been, in compliance with all applicable Anti-Corruption Laws.

(b) Neither the Company nor any Company Subsidiary, nor to the knowledge of the Company or any Company Subsidiary, any officers, directors, executives, employees, shareholders, agents, or representatives or other party acting for or on behalf of any of the Company or any Company Subsidiary, has at any time (i) offered, authorized, promised, provided, or received any payments or anything else of value, whether directly or indirectly through a third party, in violation of the Anti-Corruption Laws, (ii) established or maintained, or is maintaining, any unlawful fund of corporate monies or other properties or made any false, incomplete, or misleading entries on any books or records for any purpose, (iii) used or is using, directly or indirectly through a third party, any corporate funds for any illegal contributions, gifts, entertainment, payments, travel, or other unlawful expenses, (iv) directly or indirectly through a third party, offered, authorized, promised, or provided anything else of value for the purpose of obtaining, retaining, and/or securing an improper advantage for the Company or any Company Subsidiary, or (v) has been or currently

is under administrative, civil, or criminal investigation, indictment, suspension, debarment, or audit by any party, in connection with alleged or possible violations of any Anti-Corruption Laws or applicable Laws that prohibit fraud, money laundering, or other improper payments.

(c) For the last six (6) years, the Company and all Company Subsidiaries have adopted and maintained adequate policies, procedures, and controls to ensure that the Company and all Company Subsidiaries have been and remain in compliance with all Anti-Corruption Laws.

(d) For the last six (6) years, the Company and all Company Subsidiaries have maintained accounting and financial controls adequate to ensure that: (i) all payments and activities have been accurately recorded in the books, records and accounts for the Company and each of the Company Subsidiaries; (ii) there have been no false, inaccurate, misleading, or incomplete entries made in the books, records, and accounts of the Company and all Company Subsidiaries; and (iii) the Company and all Company Subsidiaries have not established or maintained any secret or unrecorded funds or accounts. The books, records, and accounts of the Company and each of the Company Subsidiaries accurately reflect in reasonable detail the character and amount of all transactions, and the Company and all Company Subsidiaries have not had or maintained any bank or other financial account that is not or was not accurately disclosed in their books, records, and accounts.

(e) Neither the U.S. government nor any other Governmental Authority, nor any other entity or person, has notified the Company or any Company Subsidiary of any actual or alleged violation or breach of Anti-Corruption Laws or applicable laws that prohibit fraud, money laundering, or other improper payments. Neither the Company nor any Company Subsidiary has undergone and is not undergoing any review, investigation, inspection, or examination of records relating to the Company's or any Company Subsidiary's compliance with Anti-Corruption Laws. Neither the Company nor any Company Subsidiary has been, is now under, or has received any communication regarding any actual or potential administrative, civil, or criminal investigation, prosecution, or indictment, and are not party to any actions involving alleged false statements, false claims or other improprieties relating to compliance with Anti-Corruption Laws.

**SECTION 4.22 Interested Party Transactions.** Except for employment relationships and the payment of compensation, benefits and expense reimbursements and advances in the ordinary course of business, no director, officer or other affiliate of the Company or any Company Subsidiary, to the Company's knowledge, has or has had, directly or indirectly: (a) an economic interest in any person that has furnished or sold, or furnishes or sells, services or Products that the Company or any Company Subsidiary furnishes or sells, or proposes to furnish or sell; (b) an economic interest in any person that purchases from or sells or furnishes to, the Company or any Company Subsidiary, any goods or services; (c) a beneficial interest in any contract or agreement disclosed in Schedule 4.17(a) of the Company Disclosure Schedule; or (d) any contractual or other arrangement with the Company or any Company Subsidiary, other than customary indemnity arrangements; provided, however, that ownership of no more than five percent (5%) of the outstanding voting stock of a publicly traded corporation shall not be deemed an "economic interest in any person" for purposes of this Section 4.22. The Company and the Company Subsidiaries have not, since January 1, 2019, (i) extended or maintained credit, arranged for the extension of credit or renewed an extension of credit in the form of a personal loan to or for any director or executive officer (or equivalent thereof) of the Company, or (ii) materially modified any term of any such extension or maintenance of credit.

**SECTION 4.23 Exchange Act.** Neither the Company nor any Company Subsidiary is currently (or has previously been) subject to the requirements of Section 12 of the Securities Exchange Act of 1934, as amended (the "Exchange Act").

**SECTION 4.24 Health Care Compliance.**

(a) Each of the Company and applicable Company Subsidiaries is operating, and at all times during the past six (6) years has operated, in compliance in all material respects with all Health Care Laws. None of the

Company, applicable Company Subsidiaries and their respective affiliates or their respective directors, officers, managers, and, to the knowledge of the Company, its employees and consultants is in violation of or being investigated for violation of any Health Care Laws by which such Person is bound or to which any business activity or professional services performed by such Person for the Company (including services provided to other Persons but arranged by the Company) is subject. There are no material restrictions imposed by any Governmental Authority upon the business, activities or services of the Company, other than those generally applicable to companies that provide services similar to those provided by the Company. Each health care professional employed or otherwise retained by the Company (each, a "Provider") has in good standing all permits required for such Person to perform such Person's duties for the Company (including services provided to other Persons but arranged by the Company) and for the Company to obtain payment or reimbursement from patients.

(b) None of the Company and Company Subsidiaries is and has not during the past six (6) years participated in any Federal Health Care Programs.

(c) Exclusion of the Company from Federal Health Care Programs. None of the Company or Company Subsidiary is or ever has been (i) debarred, excluded or suspended from participating in any Federal Health Care Program, (ii) subject to a civil monetary penalty assessed under Section 1128A of the Social Security Act or (iii) listed on the General Services Administration published list of parties excluded from federal procurement programs and non-procurement programs.

(d) None of the current directors, officers, managers, employees or independent contractors of the Company or applicable Company Subsidiary is or ever has been during such Person's affiliation with the Company (i) debarred, excluded or suspended from participating in any Federal Health Care Program, (ii) subject to a civil monetary penalty assessed under Section 1128A of the Social Security Act, sanctioned, indicted or convicted of a crime, or pled nolo contendere or to sufficient facts, in connection with any allegation of violation of any Federal Health Care Program requirement or Health Care Law, (iii) listed on the General Services Administrative published list of parties excluded from federal procurement programs and non-procurement programs or (iv) designated a Specially Designated National or Blocked Person by the Office of Foreign Asset Control of the U.S. Department of Treasury.

(e) The Company, Company Subsidiaries, and its directors, managers, officers, personnel (whether employed or engaged as independent contractors), and authorized representatives are operating and for the past six (6) years operated in compliance in all material respects with the federal health care program anti-kickback statute (42 U.S.C. § 1320a-7b, *et seq.*), the federal physician self-referral law (commonly known as the Stark Law) (42 U.S.C. § 1395nn, *et seq.*, and its implementing regulations, 42 C.F.R. Subpart J), and California equivalent statutes, and all other applicable Health Care Laws with respect to direct and indirect compensation arrangements, ownership interests or other relationships between such Person and any past, present or potential patient, physician, supplier, contractor, third-party payor or other Person in a position to refer, recommend or arrange for the referral of patients or other health care business to such Person (a "Referral Source") or to whom such Person refers, recommends or arranges for the referral of patients or other health care business (a "Referral Recipient"). Schedule 4.24(e) of the Company Disclosure Schedule lists all direct and indirect compensation arrangements, ownership interests and other financial relationships between a Referral Source or Referral Recipient on the one hand, and the Company or any of its directors, managers, officers, personnel (whether employed or engaged as independent contractors), and authorized representatives, on the other hand. None of the Company's independent contractors currently provide or ever has provided, directly or indirectly, sales representative or marketing services to the Company's Referral Recipients.

(f) None of the Company, Company Subsidiaries, and their facilities are accredited by The Joint Commission or any other third-party accreditation organization.

**SECTION 4.25 Brokers.** Except as set forth in Schedule 4.25 of the Company Disclosure Schedule, no broker, finder or investment banker is entitled to any brokerage, finder's or other fee or commission in connection with the Transactions based upon arrangements made by or on behalf of the Company or any Company Subsidiary.

**SECTION 4.26 Exclusivity of Representations and Warranties.** Except as otherwise expressly provided in this Article IV (as modified by the Company Disclosure Schedule), the Company hereby expressly disclaims and negates, any other express or implied representation or warranty whatsoever (whether at Law or in equity) with respect to the Company, its affiliates, and any matter relating to any of them, including their affairs, the condition, value or quality of the assets, liabilities, financial condition or results of operations, or with respect to the accuracy or completeness of any other information made available to GigCapital5, its affiliates or any of their respective Representatives by, or on behalf of, Company, and any such representations or warranties are expressly disclaimed. Without limiting the generality of the foregoing, except as expressly set forth in this Agreement, neither Company nor any other person on behalf of Company has made or makes, any representation or warranty, whether express or implied, with respect to any projections, forecasts, estimates or budgets made available to GigCapital5, its affiliates or any of their respective Representatives of future revenues, future results of operations (or any component thereof), future cash flows or future financial condition (or any component thereof) of the Company (including the reasonableness of the assumptions underlying any of the foregoing), whether or not included in any management presentation or in any other information made available to GigCapital5, its affiliates or any of their respective Representatives or any other person, and that any such representations or warranties are expressly disclaimed.

## **ARTICLE V. REPRESENTATIONS AND WARRANTIES OF GIGCAPITAL5 AND MERGER SUB**

Except as set forth in the GigCapital5 SEC Reports (to the extent the qualifying nature of such disclosure is readily apparent from the content of such GigCapital5 SEC Reports, but excluding disclosures referred to in "Forward-Looking Statements", "Risk Factors", and any other disclosures therein to the extent they are of a predictive or cautionary nature or related to forward-looking statements) (it being acknowledged that nothing disclosed in such a GigCapital5 SEC Report will be deemed to modify or qualify the representations and warranties set forth in Section 5.01 (Corporate Organization), Section 5.03 (Capitalization), and Section 5.04 (Authority Relative to This Agreement)), GigCapital5 hereby represents and warrants to the Company as follows:

### **SECTION 5.01 Corporate Organization.**

(a) Each of GigCapital5 and Merger Sub is a corporation duly organized, validly existing and in good standing under the laws of the jurisdiction of its incorporation and has the requisite corporate power and authority and all necessary governmental approvals to own, lease, and operate its properties and to carry on its business as it is now being conducted, except where the failure to have such power, authority and governmental approvals would not be a GigCapital5 Material Adverse Effect.

(b) Merger Sub is the only subsidiary of GigCapital5. Except for Merger Sub, GigCapital5 does not directly or indirectly own any equity or similar interest in, or any interest convertible into or exchangeable or exercisable for any equity or similar interest in, any corporation, partnership, joint venture or business association or other person.

**SECTION 5.02 Certificate of Incorporation and Bylaws.** Each of GigCapital5 and Merger Sub has heretofore furnished to the Company complete and correct copies of the GigCapital5 Organizational Documents and the Merger Sub Organizational Documents. The GigCapital5 Organizational Documents and the Merger Sub Organizational Documents are in full force and effect. Neither GigCapital5 nor Merger Sub is in violation of any of the provisions of the GigCapital5 Organizational Documents and the Merger Sub Organizational Documents, respectively.

### SECTION 5.03 Capitalization

(a) The authorized capital stock of GigCapital5 consists of (i) one-hundred million (100,000,000) shares of GigCapital5 Common Stock, and (ii) one million (1,000,000) shares of preferred stock, par value \$0.0001 per share (“GigCapital5 Preferred Stock”). As of the date of this Agreement (i) ten million five-hundred and fifty-nine thousand and fifty (10,559,050) shares of GigCapital5 Common Stock are issued and outstanding (which includes four million fourteen thousand and fifty (4,014,050) shares subject to Redemption Rights), all of which are validly issued, fully paid and non-assessable and not subject to any preemptive rights, (ii) no shares of GigCapital5 Common Stock are held in the treasury of GigCapital5, (iii) twenty-three million seven-hundred and ninety-five thousand (23,795,000) GigCapital5 Warrants are issued and outstanding, and (iv) twenty-three million seven-hundred and ninety-five thousand (23,795,000) shares of GigCapital5 Common Stock are reserved for future issuance pursuant to the GigCapital5 Warrants. As of the date of this Agreement, there are no shares of GigCapital5 Preferred Stock issued and outstanding. Each GigCapital5 Warrant is exercisable for one share of GigCapital5 Common Stock at an exercise price of \$11.50.

(b) As of the date of this Agreement, the authorized capital stock of Merger Sub consists of ten thousand (10,000) shares of common stock, par value \$0.0001 per share (the “Merger Sub Common Stock”). As of the date hereof, of ten thousand (10,000) shares of Merger Sub Common Stock are issued and outstanding. All outstanding shares of Merger Sub Common Stock have been duly authorized, validly issued, fully paid and are non-assessable and are not subject to preemptive rights and are held by GigCapital5 free and clear of all Liens, other than transfer restrictions under applicable securities laws and the Merger Sub Organizational Documents.

(c) All outstanding GigCapital5 Units, shares of GigCapital5 Common Stock and GigCapital5 Warrants have been issued and granted in compliance with all applicable securities laws and other applicable Laws and were issued free and clear of all Liens other than transfer restrictions under applicable securities laws and the GigCapital5 Organizational Documents.

(d) The Per Share Merger Consideration being delivered by GigCapital5 hereunder shall be duly and validly issued, fully paid and non-assessable, and each such share or other security shall be issued free and clear of preemptive rights and all Liens, other than transfer restrictions under applicable securities laws and the GigCapital5 Organizational Documents. The Per Share Merger Consideration will be issued in compliance with all applicable securities Laws and other applicable Laws and without contravention of any other person’s rights therein or with respect thereto.

(e) Except for securities issued by GigCapital5 as permitted by this Agreement and the GigCapital5 Warrants, GigCapital5 has not issued any options, warrants, preemptive rights, calls, convertible securities or other rights, agreements, arrangements or commitments of any character relating to the issued or unissued capital stock of GigCapital5 or obligating GigCapital5 to issue or sell any shares of capital stock of, or other equity interests in, GigCapital5. All shares of GigCapital5 Common Stock subject to issuance as aforesaid, upon issuance on the terms and conditions specified in the instruments pursuant to which they are issuable, will be duly authorized, validly issued, fully paid and non-assessable. Neither GigCapital5 nor any subsidiary of GigCapital5 is a party to, or otherwise bound by, and neither GigCapital5 nor any subsidiary of GigCapital5 has granted, any equity appreciation rights, participations, phantom equity or similar rights. GigCapital5 is not a party to any voting trusts, voting agreements, proxies, shareholder agreements or other agreements with respect to the voting or transfer of GigCapital5 Common Stock or any of the equity interests or other securities of GigCapital5 or any of its subsidiaries. Except as provided for in the GigCapital5 Certificate of Incorporation, there are no outstanding contractual obligations of GigCapital5 to repurchase, redeem or otherwise acquire any shares of GigCapital5 Common Stock. There are no outstanding contractual obligations of GigCapital5 to make any investment (in the form of a loan, capital contribution or otherwise) in, any person.

**SECTION 5.04 Authority Relative to This Agreement.** Each of GigCapital5 and Merger Sub have all necessary power and authority to execute and deliver this Agreement, to perform its obligations hereunder and to consummate the Transactions. The execution and delivery of this Agreement by each of GigCapital5 and Merger Sub and the consummation by each of GigCapital5 and Merger Sub of the Transactions, have been duly and validly authorized by all necessary corporate action, and no other corporate proceedings on the part of GigCapital5 or Merger Sub are necessary to authorize this Agreement or to consummate the Transactions (other than (a) with respect to the Merger, the approval and adoption of this Agreement by the holders of a majority of the then-outstanding shares of GigCapital5 Common Stock and by the holders of a majority of the then-outstanding shares of Merger Sub Common Stock, and the filing and recordation of appropriate merger documents as required by the DGCL, and (b) with respect to the issuance of GigCapital5 Common Stock and the amendment and restatement of the GigCapital5 Certificate of Incorporation pursuant to this Agreement, the approval of a majority of the then-outstanding shares of GigCapital5 Common Stock). This Agreement has been duly and validly executed and delivered by GigCapital5 and Merger Sub and, assuming due authorization, execution and delivery by the Company, constitutes a legal, valid and binding obligation of GigCapital5 and Merger Sub, enforceable against GigCapital5 and Merger Sub in accordance with its terms, subject to the Remedies Exceptions.

**SECTION 5.05 No Conflict; Required Filings and Consents.**

(a) The execution and delivery of this Agreement by each of GigCapital5 and Merger Sub do not, and the performance of this Agreement by each of GigCapital5 and Merger Sub will not, (i) conflict with or violate the GigCapital5 Organizational Documents or the Merger Sub Organizational Documents, (ii) assuming that all consents, approvals, authorizations and other actions described in Section 5.05(b) have been obtained and all filings and obligations described in Section 5.05(b) have been made, conflict with or violate any Law, rule, regulation, order, judgment or decree applicable to each of GigCapital5 or Merger Sub or by which any of their property or assets is bound or affected, or (iii) result in any breach of, or constitute a default (or an event which, with notice or lapse of time or both, would become a default) under, or give to others any rights of termination, amendment, acceleration or cancellation of, or result in the creation of a Lien on any property or asset of each of GigCapital5 or Merger Sub pursuant to, any note, bond, mortgage, indenture, contract, agreement, lease, license, permit, franchise or other instrument or obligation to which each of GigCapital5 or Merger Sub is a party or by which each of GigCapital5 or Merger Sub or any of their property or assets is bound or affected, except, with respect to clauses (ii) and (iii), for any such conflicts, violations, breaches, defaults or other occurrences which would not have or reasonably be expected to have a GigCapital5 Material Adverse Effect.

(b) The execution and delivery of this Agreement by each of GigCapital5 and Merger Sub do not, and the performance of this Agreement by each of GigCapital5 and Merger Sub will not, require any consent, approval, authorization or permit of, or filing with or notification to, any Governmental Authority, except (i) for applicable requirements, if any, of the Exchange Act, Blue Sky Laws and state takeover laws, the pre-merger notification requirements of the HSR Act, and filing and recordation of appropriate merger documents as required by the DGCL and (ii) where the failure to obtain such consents, approvals, authorizations or permits, or to make such filings or notifications, would not, individually or in the aggregate, prevent or materially delay consummation of any of the Transactions or otherwise prevent GigCapital5 or Merger Sub from performing its material obligations under this Agreement.

**SECTION 5.06 Compliance.** Neither GigCapital5 nor Merger Sub is or has been in conflict with, or in default, breach or violation of, (a) any Law applicable to GigCapital5 or Merger Sub or by which any property or asset of GigCapital5 or Merger Sub is bound or affected, or (b) any note, bond, mortgage, indenture, contract, agreement, lease, license, permit, franchise or other instrument or obligation to which GigCapital5 or Merger Sub is a party or by which GigCapital5 or Merger Sub or any property or asset of GigCapital5 or Merger Sub is bound, except, in each case, for any such conflicts, defaults, breaches or violations that would not have or reasonably be expected to have a GigCapital5 Material Adverse Effect. Each of GigCapital5 and Merger Sub is



in possession of all material franchises, grants, authorizations, licenses, permits, easements, variances, exceptions, consents, certificates, approvals, and orders of any Governmental Authority necessary for GigCapital5 or Merger Sub to own, lease and operate its properties or to carry on its business as it is now being conducted.

**SECTION 5.07 SEC Filings: Financial Statements: Sarbanes-Oxley.**

(a) GigCapital5 has filed all forms, reports, schedules, statements and other documents, including any exhibits thereto, required to be filed by it with the Securities and Exchange Commission (the “SEC”) since September 23, 2021, together with any amendments, restatements or supplements thereto (collectively, the “GigCapital5 SEC Reports”). GigCapital5 has heretofore furnished to the Company true and correct copies of all amendments and modifications that have not been filed by GigCapital5 with the SEC to all agreements, documents and other instruments that previously had been filed by GigCapital5 with the SEC and are currently in effect. As of their respective dates, the GigCapital5 SEC Reports (i) complied in all material respects with the applicable requirements of the Securities Act of 1933, as amended (the “Securities Act”), the Exchange Act and the Sarbanes-Oxley Act, and the rules and regulations promulgated thereunder, and (ii) did not, at the time they were filed, or, if amended, as of the date of such amendment, contain any untrue statement of a material fact or omit to state a material fact required to be stated therein or necessary in order to make the statements made therein, in the light of the circumstances under which they were made, not misleading. Each director and executive officer of GigCapital5 has filed with the SEC on a timely basis all documents required with respect to GigCapital5 by Section 16(a) of the Exchange Act and the rules and regulations thereunder.

(b) Each of the financial statements (including, in each case, any notes thereto) contained in the GigCapital5 SEC Reports was prepared in accordance with GAAP (applied on a consistent basis) and Regulation S-X and Regulation S-K, as applicable, throughout the periods indicated (except as may be indicated in the notes thereto or, in the case of unaudited financial statements, as permitted by Form 10-Q of the SEC) and each fairly presents, in all material respects, the financial position, results of operations, changes in stockholders equity and cash flows of GigCapital5 as at the respective dates thereof and for the respective periods indicated therein, (subject, in the case of unaudited statements, to normal and recurring year-end adjustments which have not had, and would not reasonably be expected to individually or in the aggregate be material). GigCapital5 has no off-balance sheet arrangements that are not disclosed in the GigCapital5 SEC Reports. No financial statements other than those of GigCapital5 are required by GAAP to be included in the consolidated financial statements of GigCapital5.

(c) Except as and to the extent set forth in the GigCapital5 SEC Reports, neither GigCapital5 nor Merger Sub has any liability or obligation of a nature (whether accrued, absolute, contingent or otherwise) required to be reflected on a balance sheet prepared in accordance with GAAP, except for liabilities and obligations arising in the ordinary course of GigCapital5’s and Merger Sub’s business.

(d) GigCapital5 is in compliance in all material respects with the applicable listing and corporate governance rules and regulations of Nasdaq.

(e) GigCapital5 has established and maintains disclosure controls and procedures (as defined in Rule 13a-15 under the Exchange Act). Such disclosure controls and procedures are designed to ensure that material information relating to GigCapital5 and other material information required to be disclosed by GigCapital5 in the reports and other documents that it files or furnishes under the Exchange Act is recorded, processed, summarized and reported within the time periods specified in the rules and forms of the SEC, and that all such material information is accumulated and communicated to GigCapital5’s principal executive officer and its principal financial officer as appropriate to allow timely decisions regarding required disclosure and to make the certifications required pursuant to Sections 302 and 906 of the Sarbanes-Oxley Act. Such disclosure controls and procedures are effective in timely alerting GigCapital5’s principal executive officer and principal financial officer to material information required to be included in GigCapital5’s periodic reports required under the Exchange Act.

(f) GigCapital5 maintains systems of internal control over financial reporting that are sufficient to provide reasonable assurance regarding the reliability of financial reporting and the preparation of financial statements for external purposes in accordance with GAAP, including policies and procedures sufficient to provide reasonable assurance: (i) that GigCapital5 maintains records that in reasonable detail accurately and fairly reflect, in all material respects, its transactions and dispositions of assets; (ii) that transactions are recorded as necessary to permit the preparation of financial statements in conformity with GAAP; (iii) that receipts and expenditures are being made only in accordance with authorizations of management and its board of directors; and (iv) regarding prevention or timely detection of unauthorized acquisition, use or disposition of its assets that could have a material effect on its financial statements. GigCapital5 has delivered to the Company a true and complete copy of any disclosure (or, if unwritten, a summary thereof) by any representative of GigCapital5 to GigCapital5's independent auditors relating to any material weaknesses in internal controls and any significant deficiencies in the design or operation of internal controls that would adversely affect the ability of GigCapital5 to record, process, summarize and report financial data. GigCapital5 has no knowledge of any fraud or whistle-blower allegations, whether material, that involve management or other employees or consultants who have or had a significant role in the internal control over financial reporting of GigCapital5. Since September 23, 2021, there have been no material changes in GigCapital5 internal control over financial reporting.

(g) There are no outstanding loans or other extensions of credit made by GigCapital5 to any executive officer (as defined in Rule 3b-7 under the Exchange Act) or director of GigCapital5. GigCapital5 has not taken any action prohibited by Section 402 of the Sarbanes-Oxley Act.

(h) Neither GigCapital5 (including any employee thereof) nor GigCapital5's independent auditors has identified or been made aware of (i) any significant deficiency or material weakness in the system of internal accounting controls utilized by GigCapital5, (ii) any fraud, whether or not material, that involves GigCapital5's management or other employees who have a role in the preparation of financial statements or the internal accounting controls utilized by GigCapital5, or (iii) any claim or allegation regarding any of the foregoing.

(i) As of the date hereof, there are no outstanding SEC comments from the SEC with respect to the GigCapital5 SEC Reports. To the knowledge of GigCapital5, none of the GigCapital5 SEC Reports filed on or prior to the date hereof is subject to ongoing SEC review or investigation as of the date hereof.

**SECTION 5.08 Absence of Certain Changes or Events.** Since September 23, 2021, except as expressly contemplated by this Agreement,

(a) GigCapital5 has conducted its business in the ordinary course and in a manner consistent with past practice, and (b) there has not been any GigCapital5 Material Adverse Effect.

**SECTION 5.09 Business Activities.**

(a) Since inception, GigCapital5 has not conducted any business activities other than activities directed toward the accomplishment of a business combination. Except as set forth in the GigCapital5 Organizational Documents or as otherwise contemplated by this Agreement or the Transaction Documents, there is no agreement, commitment or order binding upon GigCapital5 or to which GigCapital5 is a party which has had or would reasonably be expected to have the effect of prohibiting or impairing any business practice of GigCapital5 or any acquisition of property by GigCapital5 or the conduct of business by GigCapital5 as currently conducted or as contemplated to be conducted as of the Closing other than such effects, individually or in the aggregate, which have not had and would not constitute a GigCapital5 Material Adverse Effect.

(b) None of GigCapital5 or Merger Sub owns or has a right to acquire, directly or indirectly, any interest or investment (whether equity or debt) in any corporation, partnership, joint venture, business, trust or other entity. Except for the Transaction Documents, GigCapital5 has no interests, rights, obligations or liabilities with respect to, and is not party to, bound by or has its assets or property subject to, in each case whether directly or indirectly, any contract or transaction which is, or could reasonably be interpreted as constituting, a business combination.

(c) Except for this Agreement and the agreements expressly contemplated hereby, GigCapital5 is not, and at no time has been, party to any contract with any other person that would require payments by GigCapital5 in excess of \$50,000 monthly, \$400,000 in the aggregate annually with respect to any individual contract or more than \$1,000,000 in the aggregate annually when taken together with all other contracts (other than, this Agreement and the Transaction Documents expressly).

(d) Except as set forth in the Merger Sub Organizational Documents, there are no agreements, commitments, or order binding upon Merger Sub or to which Merger Sub is a party which has had or would reasonably be expected to have the effect of prohibiting or impairing any business practice of Merger Sub or any acquisition of property by Merger Sub or the conduct of business by Merger Sub as currently conducted or as contemplated to be conducted as of the Closing other than such effects, individually or in the aggregate, which have not had and would not reasonably be expected to have a material adverse effect on the ability of Merger Sub to enter into and perform its obligations under this Agreement or the Transaction Documents.

**SECTION 5.10 Investment Company Act.** Neither GigCapital5 nor Merger Sub is an “investment company” within the meaning of the Investment Company Act of 1940, as amended.

**SECTION 5.11 Affiliate Agreements.** Neither GigCapital5 nor Merger Sub is a party to any transaction, agreement, arrangement or understanding with any (a) present or former executive officer or director of GigCapital5 or Merger Sub, (b) beneficial owner (within the meaning of Section 13(d) of the Exchange Act) of 5% or more of the capital stock or equity interests of GigCapital5 or Merger Sub or (c) Affiliate, “associate” or member of the “immediate family” (as such terms are respectively defined in Rules 12b-2 and 16a-1 under the Exchange Act).

**SECTION 5.12 Sponsor Support Agreement.** GigCapital5 has delivered to the Company a true, correct and complete copy of the Sponsor Support Agreement. The Sponsor Support Agreement is in full force and effect and has not been withdrawn or terminated, or otherwise amended or modified, in any respect, and no withdrawal, termination, amendment or modification is contemplated by GigCapital5. The Sponsor Support Agreement is a legal, valid and binding obligation of GigCapital5 and, to the knowledge of GigCapital5, each other party thereto, subject to the Remedies Exception, and neither the execution or delivery by any party thereto of, nor the performance of any party’s obligations under, the Sponsor Support Agreement violates any provision of, or results in the breach of or default under, or requires any filing, registration or qualification under, any applicable Law. No event has occurred that, with or without notice, lapse of time or both, would constitute a default or breach on the part of GigCapital5 under any term or condition of the Sponsor Support Agreement.

**SECTION 5.13 Absence of Litigation.** There is no Action pending or, to the knowledge of GigCapital5, threatened against GigCapital5, or any property or asset of GigCapital5 before any Governmental Authority. Neither GigCapital5 nor any material property or asset of GigCapital5 is subject to any continuing order of, consent decree, settlement agreement or other similar written agreement with, or, to the knowledge of GigCapital5, continuing investigation by, any Governmental Authority.

**SECTION 5.14 Board Approval: Vote Required.**

(a) The GigCapital5 Board, by resolutions duly adopted by majority vote of those voting at a meeting duly called and held and not subsequently rescinded or modified in any way, has duly (i) determined that this Agreement and the transactions contemplated by this Agreement are fair to and in the best interests of GigCapital5 and its stockholders, (ii) approved this Agreement and the transactions contemplated by this Agreement and declared their advisability, and (iii) recommended that the stockholders of GigCapital5 approve and adopt this Agreement and Merger, and directed that this Agreement and the Merger, be submitted for consideration by the stockholders of GigCapital5 at the GigCapital5 Stockholders’ Meeting.

(b) The only vote of the holders of any class or series of capital stock of GigCapital5 necessary to approve the transactions contemplated by this Agreement is the affirmative vote of the holders of a majority of the outstanding shares of GigCapital5 Common Stock.

(c) The Merger Sub Board, by resolutions duly adopted by written consent and not subsequently rescinded or modified in any way, has duly (i) determined that this Agreement and the Merger are fair to and in the best interests of Merger Sub and its sole stockholder, (ii) approved this Agreement and the Merger and declared their advisability, and (iii) recommended that the sole stockholder of Merger Sub approve and adopt this Agreement and approve the Merger and directed that this Agreement and the transactions contemplated hereby be submitted for consideration by the sole stockholder of Merger Sub.

(d) The only vote of the holders of any class or series of capital stock of Merger Sub is necessary to approve this Agreement, the Merger and the other transactions contemplated by this Agreement is the affirmative vote of the holders of a majority of the outstanding shares of Merger Sub Common Stock.

**SECTION 5.15 No Prior Operations of Merger Sub.** Merger Sub was formed solely for the purpose of engaging in the transactions contemplated by this Agreement and has not engaged in any business activities or conducted any operations or incurred any obligation or liability, other than as contemplated by this Agreement.

**SECTION 5.16 Brokers.** Except for Northlands Securities, no broker, finder, or investment banker is entitled to any brokerage, finder's or other fee or commission in connection with the Transactions based upon arrangements made by or on behalf of GigCapital5 or Merger Sub, except that with the prior written consent of the Company, not to be unreasonably conditioned, withheld or delayed, GigCapital5 may engage with other brokers, finders or investment bankers.

**SECTION 5.17 GigCapital5 Trust Fund.** As of the date of this Agreement, GigCapital5 has no less than \$41,401,656.25 in the trust fund established by GigCapital5 for the benefit of its public stockholders (the "Trust Fund") maintained in a trust account at Oppenheimer & Co. Inc. (the "Trust Account"). The monies of such Trust Account are invested in United States Government securities or money market funds meeting certain conditions under Rule 2a-7 promulgated under the Investment Company Act of 1940, as amended, and held in trust by Continental Stock Transfer & Trust Company (the "Trustee") pursuant to the Investment Management Trust Agreement, dated as of September 23, 2021, between GigCapital5 and the Trustee (the "Trust Agreement"). The Trust Agreement has not been amended or modified and is valid and in full force and effect and is enforceable in accordance with its terms, subject to the Remedies Exceptions. GigCapital5 has complied in all material respects with the terms of the Trust Agreement and is not in breach thereof or default thereunder and there does not exist under the Trust Agreement any event which, with the giving of notice or the lapse of time, would constitute such a breach or default by GigCapital5 or the Trustee. There are no separate contracts, agreements, side letters or other understandings (whether written or unwritten, express or implied): (i) between GigCapital5 and the Trustee that would cause the description of the Trust Agreement in the GigCapital5 SEC Reports to be inaccurate in any material respect; or (ii) to the knowledge of GigCapital5, that would entitle any person (other than stockholders of GigCapital5 who shall have elected to redeem their shares of GigCapital5 Common Stock pursuant to the GigCapital5 Organizational Documents) to any portion of the proceeds in the Trust Account. Prior to the Closing, none of the funds held in the Trust Account may be released except: (A) to pay income and franchise Taxes from any interest income earned in the Trust Account; and (B) upon the exercise of Redemption Rights in accordance with the provisions of the GigCapital5 Organizational Documents. As of the date hereof, there are no Actions pending or, to the knowledge of GigCapital5, threatened in writing with respect to the Trust Account. Upon consummation of the Merger and notice thereof to the Trustee pursuant to the Trust Agreement, GigCapital5 shall cause the Trustee to, and the Trustee shall thereupon be obligated to, release to GigCapital5 as promptly as practicable, the Trust Funds in accordance with the Trust Agreement at which point the Trust Account shall terminate; provided, however that the liabilities and obligations of GigCapital5 due and owing or incurred at or prior to the Effective Time shall be paid as and when due, including all amounts payable (a) to stockholders of GigCapital5 who shall have exercised their Redemption Rights; (b) with respect to filings, applications and/or other actions taken pursuant to this Agreement required under Law; (c) to the Trustee for fees

and costs incurred in accordance with the Trust Agreement; and (d) to third parties (e.g., professionals, printers, etc.) who have rendered services to GigCapital5 in connection with its efforts to effect the Merger (including deferred fees owed by GigCapital5 to William Blair & Company L.L.C. and Wells Fargo Securities, LLC, pursuant to that certain Underwriting Agreement, dated September 23, 2021, among Wells Fargo Securities, LLC, William Blair & Company L.L.C. and GigCapital5). As of the date hereof, assuming the accuracy of the representations and warranties of the Company herein and the compliance by the Company with its respective obligations hereunder, GigCapital5 has no reason to believe that any of the conditions to the use of funds in the Trust Account will not be satisfied or funds available in the Trust Account will not be available to GigCapital5 at the Effective Time.

**SECTION 5.18 Employees.** Other than any officers as described in the GigCapital5 SEC Reports, GigCapital5 and Merger Sub have never employed any employees or retained any contractors or consultants. Other than reimbursement of any out-of-pocket expenses incurred by GigCapital5's officers and directors in connection with activities on GigCapital5's behalf in an aggregate amount not in excess of the amount of cash held by GigCapital5 outside of the Trust Account, GigCapital5 and Merger Sub have no unsatisfied material liability with respect to any employee, officer, or director. GigCapital5 and Merger Sub have never and do not currently maintain, sponsor, contribute to or have any liability, actual or contingent, including through association with an ERISA Affiliate, under any employment agreement, or any employee benefit plan (as defined in Section 3(3) of ERISA), nonqualified deferred compensation plan subject to Section 409A of the Code, bonus, stock option, stock purchase, restricted stock, incentive, deferred compensation, retiree medical or life insurance, supplemental retirement, change in control, fringe benefit, sick pay, and vacation plans or arrangements or other employee benefit plans, programs or arrangements. Neither the execution and delivery of this Agreement by GigCapital5 nor the consummation of the Transactions contemplated by this Agreement (either alone or in combination with another event) will (i) result in the payment of severance or any other amount to any employee, director, officer or independent contractor of GigCapital5 or Merger Sub, (ii) accelerate the time of payment or vesting, or increase the amount, of any benefit or other compensation due to any individual by GigCapital5 or Merger Sub, (iii) result in an "excess parachute payment" as defined in Section 280G(b)(1) of the Code, or (iv) require a "gross-up," indemnification for, or payment to any employee, director, officer or independent contractor of GigCapital5 or Merger Sub for any Taxes imposed under Section 409A or Section 4999 of the Code or otherwise.

**SECTION 5.19 Taxes.**

(a) GigCapital5 and Merger Sub (i) have duly and timely filed (taking into account any extension of time within which to file) all income and other material Tax Returns required to be filed by any of them and all such filed Tax Returns are complete and accurate in all material respects; (ii) have timely paid all material Taxes (whether or not shown on any Tax Return) that they were obligated to pay, except with respect to current Taxes not yet due and payable, Taxes that are being contested in good faith or that are described in clause (a)(v) below; (iii) with respect to all income and other material Tax Returns filed by or with respect to any of them, have not waived any statute of limitations with respect to Taxes or agreed to any extension of time with respect to a Tax assessment or deficiency; (iv) do not have any deficiency, assessment, claim, audit, examination, investigation, litigation or other proceeding in respect of a material amount of Taxes or material Tax matters pending or threatened in writing, for a Tax period which the statute of limitations for assessments remains open; and (v) have provided adequate reserves in accordance with GAAP in the most recent consolidated financial statements of GigCapital5, for any material Taxes of GigCapital5 that have not been paid, whether or not shown as being due on any Tax Return.

(b) Neither GigCapital5 nor Merger Sub is a party to, is bound by or has an obligation under any material Tax sharing agreement, Tax indemnification agreement, Tax allocation agreement or similar contract or arrangement (excluding any agreement, contract, or arrangement the primary purpose of which does not relate to Taxes) or has a potential liability or obligation to any person as a result of or pursuant to any such agreement, contract, arrangement, or commitment other than an agreement, contract, arrangement,

or commitment entered into in the ordinary course of business the primary purpose of which does not relate to Taxes.

(c) Neither GigCapital5 nor Merger Sub will be required to include any material item of income in, or exclude any material item of deduction from, taxable income for any taxable period (or portion thereof) ending after the Closing Date as a result of any: (i) change in method of accounting for a taxable period ending on or prior to the Closing Date under Section 481(c) of the Code (or any corresponding or similar provision of state, local or foreign income Tax law); (ii) "closing agreement" as described in Section 7121 of the Code (or any corresponding or similar provision of state, local or foreign income Tax law) executed on or prior to the Closing Date; (iii) installment sale or open transaction made on or prior to the Closing Date; (iv) intercompany transaction or any excess loss account described in Treasury Regulations under Section 1502 of the Code (or any corresponding or similar provision of state, local or foreign income Tax law) entered into or created on or prior to the Closing Date; or (v) prepaid amount received on or prior to the Closing Date outside the ordinary course of business.

(d) Neither GigCapital5 nor Merger Sub has been a member of an affiliated group filing a consolidated, combined, or unitary U.S. federal, state, local or foreign income Tax Return (other than a group of which GigCapital5 was the common parent).

(e) Neither GigCapital5 nor Merger Sub has any material liability for the Taxes of any person (other than GigCapital5 or Merger Sub) under Treasury Regulation Section 1.1502-6 (or any similar provision of state, local or foreign law), as a transferee or successor, by contract (but excluding any contract the primary purpose of which does not relate to taxes), or otherwise.

(f) Neither GigCapital5 nor Merger Sub (i) has any request for a material ruling in respect of Taxes pending between GigCapital5 and/or Merger Sub, on the one hand, and any Tax authority, on the other hand; or (ii) has entered into any closing agreement, private letter ruling, technical advice memoranda or similar agreements with any Tax authority.

(g) Neither GigCapital5 nor Merger Sub has in any year for which the applicable statute of limitations remains open distributed stock of another person, or has had its stock distributed by another person, in a transaction that was purported or intended to be governed in whole or in part by Section 355 or Section 361 of the Code.

(h) Neither GigCapital5 nor Merger Sub has engaged in or entered into a "listed transaction" within the meaning of Treasury Regulation Section 1.6011-4(b)(2).

(i) Neither the IRS nor any other Tax authority has asserted in writing or, to the knowledge of GigCapital5, has threatened to assert against GigCapital5 or Merger Sub any deficiency or claim for any material Taxes.

(j) Neither GigCapital5 nor Merger Sub (i) has been a United States real property holding corporation within the meaning of Section 897(c)(2) of the Code during the applicable period specified in Section 897(c)(1)(A)(ii) of the Code; or (ii) has received written notice from a non-United States Tax authority that it has a permanent establishment (within the meaning of an applicable Tax treaty) or otherwise has an office or fixed place of business in a country other than the country in which it is organized.

(k) Neither GigCapital5 nor Merger Sub has taken, has agreed to take, or intends to take, in each case, any action that could reasonably be expected to prevent or impede the transactions contemplated by this Agreement from qualifying for the Intended Tax Treatment. To the knowledge of GigCapital5, no facts or circumstances exist that could reasonably be expected to prevent or impede the transactions contemplated by this Agreement from qualifying for the Intended Tax Treatment.

**SECTION 5.20 Listing.** The issued and outstanding GigCapital5 Units are registered pursuant to Section 12(b) of the Exchange Act and are listed for trading on the NYSE under the symbol "GIA.U." The issued and outstanding shares of GigCapital5 Common Stock are registered pursuant to Section 12(b) of the Exchange

Act and are listed for trading on the NYSE under the symbol "GIA." The issued and outstanding GigCapital5 Warrants are registered pursuant to Section 12(b) of the Exchange Act and are listed for trading on the NYSE under the symbol "GIA.WS." As of the date of this Agreement, there is no Action pending or, to the knowledge of GigCapital5, threatened in writing against GigCapital5 by the NYSE or the SEC with respect to any intention by such entity to deregister the GigCapital5 Units, the shares of GigCapital5 Common Stock or GigCapital5 Warrants or terminate the listing of GigCapital5 on the NYSE. None of GigCapital5 or any of its affiliates has taken any action in an attempt to terminate the registration of the GigCapital5 Units, the shares of GigCapital5 Common Stock or the GigCapital5 Warrants under the Exchange Act.

**SECTION 5.21 GigCapital5's and Merger Sub's Investigation and Reliance.** Each of GigCapital5 and Merger Sub is a sophisticated purchaser and has made its own independent investigation, review and analysis regarding the Company and any Company Subsidiary and the Transactions, which investigation, review and analysis were conducted by GigCapital5 and Merger Sub together with expert advisors, including legal counsel, that they have engaged for such purpose. GigCapital5, Merger Sub and their Representatives have been provided with full and complete access to the Representatives, properties, offices, plants and other facilities, books and records of the Company and any Company Subsidiary and other information that they have requested in connection with their investigation of the Company and Company Subsidiary and the Transactions. Neither GigCapital5 nor Merger Sub is relying on any statement, representation, or warranty, oral or written, express or implied, made by the Company or any Company Subsidiary or any of their respective Representatives, except as expressly set forth in Article IV (as modified by the Company Disclosure Schedule). Neither the Company nor any of its respective stockholders, affiliates or Representatives shall have any liability to GigCapital5, Merger Sub or any of their respective stockholders, affiliates or Representatives resulting from the use of any information, documents or materials made available to GigCapital5 or Merger Sub or any of their Representatives, whether orally or in writing, in any confidential information memoranda, "data rooms," management presentations, due diligence discussions or in any other form in expectation of the Transactions. Neither the Company nor any of its stockholders, affiliates or Representatives is making, directly or indirectly, any representation or warranty with respect to any estimates, projections or forecasts involving the Company and/or any Company Subsidiary.

## **ARTICLE VI. CONDUCT OF BUSINESS PENDING THE MERGER**

### **SECTION 6.01 Conduct of Business by the Company Pending the Merger.**

(a) The Company agrees that, between the date of this Agreement and the Effective Time or the earlier termination of this Agreement, except as (1) expressly contemplated by any other provision of this Agreement, any Ancillary Agreement, (2) as set forth in Schedule 6.01 attached hereto, or (3) as required by applicable Law (including COVID-19 Measures as may be requested or compelled by any Governmental Authority), unless GigCapital5 shall otherwise consent in writing (which consent shall not be unreasonably conditioned, withheld or delayed):

(i) the Company shall, and shall cause the Company Subsidiaries to, conduct their business in the ordinary course of business and in a manner consistent with past practice (with any COVID-19 Action taken prior to the date of this Agreement being deemed to be in the ordinary course of business consistent with past practice when determining whether actions taken after the date of this Agreement are in the ordinary course of business consistent with past practice); and

(ii) the Company shall use its commercially reasonable efforts to preserve substantially intact the business organization of the Company and the Company Subsidiaries, to keep available the services of the current officers, key employees and key Contingent Workers of the Company and the Company Subsidiaries and to preserve the current relationships of the Company and the Company Subsidiaries with customers, suppliers and other persons with which the Company or any Company Subsidiary has significant business relations.

(b) By way of amplification and not limitation, except as (1) expressly contemplated by any other provision of this Agreement, any Ancillary Agreement, (2) as set forth in Schedule 6.01 attached hereto, and (3) as required by applicable Law (including COVID-19 Measures as may be requested or compelled by any Governmental Authority), the Company shall not, and shall cause each Company Subsidiary not to, between the date of this Agreement and the Effective Time or the earlier termination of this Agreement, directly or indirectly, do any of the following without the prior written consent of GigCapital5 (which consent shall not be unreasonably conditioned, withheld or delayed):

(i) amend or otherwise change its certificate of incorporation or bylaws or equivalent organizational documents;

(ii) issue, sell, pledge, dispose of, grant or encumber, or authorize the issuance, sale, pledge, disposition, grant or encumbrance of: (A) any shares of any class of capital stock of the Company or any Company Subsidiary, or any options, warrants, convertible securities or other rights of any kind to acquire any shares of such capital stock, or any other ownership interest (including, without limitation, any phantom interest), of the Company or any Company Subsidiary, other than (1) the exercise or settlement of any Company Options, (2) the exercise or settlement of any Company Warrants, (3) the conversion of Company Convertible Notes into Company Common Stock contemplated under the Company Convertible Notes, or (4) the issuance of shares of Company Common Stock or Company Warrants (or the exercise or settlement of such Company Warrants issued) pursuant to the Bridge Financing; or (B) any material assets of the Company or any Company Subsidiary except in the ordinary course of business and consistent with past practice;

(iii) declare, set aside, make or pay any dividend or other distribution, payable in cash, stock, property or otherwise, with respect to any of its capital stock;

(iv) reclassify, combine, split, subdivide or redeem, or purchase or otherwise acquire, directly or indirectly, any of its capital stock, other than redemptions of equity securities from former employees upon the terms set forth in the underlying agreements governing such equity securities;

(v) (A) acquire (including, without limitation, by merger, consolidation, or acquisition of stock or assets or any other business combination) any corporation, partnership, other business organization or any division thereof in an amount in excess of \$50,000; or (B) incur any indebtedness for borrowed money or issue any debt securities or assume, guarantee or endorse, or otherwise become responsible for, the obligations of any person, or make any loans or advances, or intentionally grant any security interest in any of its assets;

(vi) (A) other than increases in base compensation of employees in the ordinary course of business that do not exceed 5% of base compensation, individually or in the aggregate, and increases required by the terms of a Plan or applicable Law, grant any increase in the compensation, incentives or benefits payable or to become payable to any current or former director, officer, employee or Contingent Worker of the Company as of the date of this Agreement, (B) enter into any new, or materially amend any existing employment or severance or termination agreement with any current or former director, officer, employee or Contingent Worker, other than in the ordinary course, consistent with past practice, (C) accelerate or commit to accelerate the funding, payment, or vesting of any compensation or benefits to any current or former director, officer, employee or Contingent Worker, (D) terminate or hire, or otherwise enter into any employment or consulting agreement or arrangement with, any person whose compensation would exceed, on an annualized basis, \$200,000; or (E) hire any new employee whose individual compensation shall exceed \$150,000;

(vii) take any action where such action could reasonably be expected to prevent or impede the transactions contemplated by this Agreement from qualifying for the Intended Tax Treatment;

(viii) other than as required by Law or pursuant to the terms of an agreement entered into prior to the date of this Agreement and reflected on Schedule 4.10(a) of the Company Disclosure Schedule or that the Company is not prohibited from entering into after the date hereof, grant any severance or



termination pay to, any director or officer of the Company or of any Company Subsidiary, other than in the ordinary course of business consistent with past practice;

(ix) adopt, amend, and/or terminate any Plan except as may be required by applicable Law, is necessary in order to consummate the Transactions, or health and welfare plan renewals in the ordinary course of business;

(x) materially amend other than reasonable and usual amendments in the ordinary course of business, with respect to accounting policies or procedures, other than as required by GAAP;

(xi) make, change or revoke any material Tax election, adopt or change any accounting method concerning Taxes, change any Tax accounting period, amend a material Tax Return or settle or compromise any material United States federal, state, local or non-United States income Tax liability, fail to pay any material Tax when due (including estimated Taxes), surrender any claim for a refund of a material amount of Taxes, waive or extend the statute of limitations in respect of a material amount of Taxes, or prepare any material Tax Return in a manner inconsistent in any material aspect with past practices;

(xii) materially amend, or modify or consent to the termination (excluding any expiration in accordance with its terms) of any Material Contract or amend, waive, modify or consent to the termination (excluding any expiration in accordance with its terms) of the Company's or any Company Subsidiary's material rights thereunder, in each case in a matter that is adverse to the Company or any Company Subsidiary, taken as a whole, except in the ordinary course of business;

(xiii) make any material alterations or improvements to the Owned Real Property or the Leased Real Property, or amend any written or oral agreements affecting the Owned Real Property or the Leased Real Property;

(xiv) intentionally permit any material item of Company IP to lapse or to be abandoned, invalidated, dedicated to the public, or disclaimed, or otherwise become unenforceable or fail to perform or make any applicable filings, recordings or other similar actions or filings, or fail to pay all required fees and taxes required or advisable to maintain and protect its interest in each and every material item of Company IP, except in the ordinary course of business; or

(xv) enter into any formal or informal agreement or otherwise make a binding commitment to do any of the foregoing.

**SECTION 6.02 Conduct of Business by GigCapital5 and Merger Sub Pending the Merger.** Except as expressly contemplated by any other provision of this Agreement or any Ancillary Agreement, and except as required by applicable Law (including any COVID-19 Measures or as may be requested or compelled by any Governmental Authority), GigCapital5 agrees that from the date of this Agreement until the earlier of the termination of this Agreement and the Effective Time, unless the Company shall otherwise consent in writing (which consent shall not be unreasonably withheld, delayed or conditioned), the businesses of GigCapital5 and Merger Sub shall be conducted in the ordinary course of business and in a manner consistent with past practice. By way of amplification and not limitation, except as expressly contemplated by any other provision of this Agreement or any Ancillary Agreement, or as required by applicable Law (including any COVID-19 Measures as may be requested or compelled by any Governmental Authority), neither GigCapital5 nor Merger Sub shall, between the date of this Agreement and the Effective Time or the earlier termination of this Agreement, directly or indirectly, do any of the following without the prior written consent of the Company, which consent shall not be unreasonably withheld, delayed or conditioned:

(a) amend or otherwise change the GigCapital5 Organizational Documents or the Merger Sub Organizational Documents or form any subsidiary of GigCapital5 other than Merger Sub, except as contemplated herein or to extend the period to consummate an initial business combination of GigCapital5 set forth in the GigCapital5 Certificate of Incorporation;

(b) declare, set aside, make or pay any dividend or other distribution, payable in cash, stock, property or otherwise, with respect to any of its capital stock, other than redemptions from the Trust Fund that are required pursuant to the GigCapital5 Organizational Documents;

(c) reclassify, combine, split, subdivide or redeem, or purchase or otherwise acquire, directly or indirectly, any of the GigCapital5 Common Stock or GigCapital5 Warrants except for redemptions from the Trust Fund that are required pursuant to the GigCapital5 Organizational Documents;

(d) other than pursuant to the Sponsor Support Agreement, (i) issue, sell, pledge, dispose of, grant or encumber, or authorize the issuance, sale, pledge, disposition, grant or encumbrance of, any shares of any class of capital stock or other securities of GigCapital5 or Merger Sub, or any options, warrants, convertible securities or other rights of any kind to acquire any shares of such capital stock, or any other ownership interest (including, without limitation, any phantom interest), of GigCapital5 or Merger Sub or (ii) amend any term of any GigCapital5 Warrants;

(e) acquire (including, without limitation, by merger, consolidation, or acquisition of stock or assets or any other business combination) any corporation, partnership, other business organization or enter into any strategic joint ventures, partnerships or alliances with any other person; or sell, lease or otherwise transfer a material amount of its assets, properties, interests or businesses, other than pursuant to existing contracts or commitments or (y) in the ordinary course of business;

(f) engage in any conduct in a new line of business or engage in any commercial activities (other than to consummate the transactions contemplated by this Agreement);

(g) except for such indebtedness as is necessary to amend the GigCapital5 Certificate of Incorporation to extend the period to consummate an initial business combination of GigCapital5 set forth in the GigCapital5 Certificate of Incorporation and to provide working capital to GigCapital5 through such period, including for such payables as have been incurred but not paid by GigCapital5 as reported in the GigCapital5 SEC Reports, incur any indebtedness for borrowed money or guarantee any such indebtedness of another person or persons, issue or sell any debt securities or options, warrants, calls or other rights to acquire any debt securities of GigCapital5, as applicable, enter into any "keep well" or other agreement to maintain any financial statement condition or enter into any arrangement having the economic effect of any of the foregoing, in each case, except in the ordinary course of business consistent with past practice;

(h) make any change in any method of financial accounting or financial accounting principles, policies, procedures or practices, except as required by a concurrent amendment in GAAP or applicable Law made subsequent to the date hereof, as agreed to by its independent accountants;

(i) make any material Tax election or settle or compromise any material United States federal, state, local or non-United States income Tax liability, except in the ordinary course consistent with past practice;

(j) take any action where such action could reasonably be expected to prevent or impede the transactions contemplated in this Agreement from qualifying for the Intended Tax Treatment;

(k) liquidate, dissolve, reorganize or otherwise wind up the business and operations of GigCapital5 or Merger Sub;

(l) settle, or offer or propose to settle, (A) any litigation, investigation, arbitration, proceeding or other claim involving or against GigCapital5 or Merger Sub, (B) any stockholder litigation or dispute against GigCapital5 or any of its officers or directors or (C) any litigation, arbitration, proceeding or dispute that relates to the Transactions, in each case, if the amount of such settlement, litigation, investigation, arbitration, dispute or other proceeding exceeds \$1,000,000 individually or in the aggregate;

(m) amend the Trust Agreement or any other agreement related to the Trust Account;

(n) (i) hire, or otherwise enter into any employment or consulting agreement or arrangement with, any person, (ii) grant any material increase in the compensation of any current or former officer or director, (iii) adopt any benefit plan for the benefit of any current or former officer or director, or (iv) materially amend any existing agreement with any current or former officer or director; or

(o) enter into any formal or informal agreement or otherwise make a binding commitment to do any of the foregoing.

**SECTION 6.03 Claims Against Trust Account.** The Company agrees that, notwithstanding any other provision contained in this Agreement, the Company does not now have, and shall not at any time prior to the Effective Time have, any claim to, or make any claim against, the Trust Fund, regardless of whether such claim arises as a result of, in connection with or relating in any way to, the business relationship between the Company on the one hand, and GigCapital5 on the other hand, this Agreement, or any other agreement or any other matter, and regardless of whether such claim arises based on contract, tort, equity or any other theory of legal liability (any and all such claims are collectively referred to in this Section 6.03 as the “Claims”). Notwithstanding any other provision contained in this Agreement, the Company hereby irrevocably waives any Claim they may have, now or in the future and will not seek recourse against the Trust Fund for any reason whatsoever in respect thereof; provided, that, for the avoidance of doubt, the foregoing waiver will not limit or prohibit the Company from pursuing a claim against GigCapital5, Merger Sub or any other person for legal relief against monies or other assets of GigCapital5 or Merger Sub held outside of the Trust Account or for specific performance or other equitable relief in connection with the Transactions. In the event that the Company commences any action or proceeding against or involving the Trust Fund in violation of the foregoing, GigCapital5 shall be entitled to recover from the Company the associated reasonable legal fees and costs in connection with any such action, in the event GigCapital5 prevails in such action or proceeding.

## **ARTICLE VII. ADDITIONAL AGREEMENTS**

### **SECTION 7.01 Proxy Statement; Registration Statement.**

(a) As promptly as practicable after the execution of this Agreement and receipt of the Initial PCAOB Financial Statements, (i) GigCapital5 (with the assistance and cooperation of the Company as reasonably requested by GigCapital5, including delivery of the PCAOB Financial Statements in accordance with Section 7.14) shall prepare and file with the SEC a joint information statement/proxy statement (as amended or supplemented, the “Proxy Statement”) to be sent to the stockholders of GigCapital5 and from which the Company may derive an information statement that it can send to the stockholders of the Company relating to (A) with respect to the Company’s stockholders, the action to be taken by certain stockholders of the Company pursuant to the Written Consent and (B) with respect to GigCapital5’s stockholders, the meeting of GigCapital5’s stockholders (the “GigCapital5 Stockholders’ Meeting”) to be held to consider approval and adoption of (1) this Agreement and the Merger, (2) the second amended and restated GigCapital5 Certificate of Incorporation as set forth on Exhibit E, (3) the Equity Plan (as defined below), (4) the classes of the members of the QTI Holdings Board as of immediately following the Effective Time, (5) the election of the Initial Post-Closing QTI Holdings Directors to serve as the members of the QTI Holdings Board as of immediately following the Effective Time and until their respective successors are duly elected or appointed and qualified, and (6) any other proposals the parties deem necessary to effectuate the Merger (collectively, the “GigCapital5 Proposals”) and (ii) GigCapital5 shall prepare and file with the SEC a registration statement on Form S-4 (together with all amendments thereto, the “Registration Statement”) in which the Proxy Statement shall be included as a prospectus, in connection with the registration under the Securities Act of the shares of GigCapital5 Common Stock to be issued to the stockholders of the Company pursuant to this Agreement. The Company shall furnish all information concerning the Company as GigCapital5 may reasonably request in connection with such actions and the preparation of the Proxy Statement and Registration Statement. GigCapital5 and the Company each shall use their reasonable best efforts to (i) cause the Registration Statement when filed with the SEC to comply in all material respects with all legal requirements applicable thereto, (ii) respond as promptly as reasonably practicable to and resolve all comments received from the SEC concerning the Registration Statement, (iii) cause the Registration Statement to be declared effective under the Securities Act as promptly as practicable, and (iv) to keep the

Registration Statement effective as long as is necessary to consummate the transactions contemplated hereby. Prior to the effective date of the Registration Statement, GigCapital5 shall take all or any action required under any applicable federal or state securities laws in connection with the issuance of shares of GigCapital5 Common Stock, in each case to be issued or issuable to the stockholders of the Company pursuant to this Agreement. As promptly as practicable after the Registration Statement is declared effective, each of the Company and GigCapital5 shall mail the Proxy Statement to their respective stockholders. Each of GigCapital5 and the Company shall furnish all information concerning it as may reasonably be requested by the other party in connection with such actions and the preparation of the Registration Statement and the Proxy Statement.

(b) No filing of, or amendment or supplement to the Proxy Statement or the Registration Statement, will be made by GigCapital5 or the Company without the approval of the other party (such approval not to be unreasonably withheld, conditioned, or delayed). GigCapital5 and the Company each will advise the other, promptly after they receive notice thereof, of the time when the Registration Statement has become effective or any supplement or amendment has been filed, of the issuance of any stop order, of the suspension of the qualification of the GigCapital5 Common Stock to be issued or issuable to the stockholders of the Company in connection with this Agreement for offering or sale in any jurisdiction, or of any request by the SEC for amendment of the Proxy Statement or the Registration Statement or comments thereon and responses thereto or requests by the SEC for additional information. Each of GigCapital5 and the Company shall cooperate and mutually agree upon (such agreement not to be unreasonably withheld or delayed), any response to comments of the SEC or its staff with respect to the Registration Statement and any amendment to the Registration Statement filed in response thereto.

(c) GigCapital5 represents that the information supplied by GigCapital5 for inclusion in the Registration Statement and the Proxy Statement shall not, at (i) the time the Registration Statement is declared effective, (ii) the time the Proxy Statement (or any amendment thereof or supplement thereto) is first mailed to the stockholders of GigCapital5, (iii) the time of the GigCapital5 Stockholders' Meeting, and (iv) the Effective Time, contain any untrue statement of a material fact or fail to state any material fact required to be stated therein or necessary in order to make the statements therein, in light of the circumstances under which they were made, not misleading. If, at any time prior to the Effective Time, any event or circumstance relating to GigCapital5 or Merger Sub, or their respective officers or directors, should be discovered by GigCapital5 which should be set forth in an amendment or a supplement to the Registration Statement or the Proxy Statement, GigCapital5 shall promptly inform the Company. All documents that GigCapital5 is responsible for filing with the SEC in connection with the Merger or the other transactions contemplated by this Agreement will comply as to form and substance in all material respects with the applicable requirements of the Securities Act and the rules and regulations thereunder and the Exchange Act and the rules and regulations thereunder.

(d) The Company represents that the information supplied by the Company for inclusion in the Registration Statement and the Proxy Statement shall not, at (i) the time the Registration Statement is declared effective, (ii) the time the Proxy Statement (or any amendment thereof or supplement thereto) is first mailed to the stockholders of GigCapital5, (iii) the time of the GigCapital5 Stockholders' Meeting, and (iv) the Effective Time, contain any untrue statement of a material fact or fail to state any material fact required to be stated therein or necessary in order to make the statements therein, in light of the circumstances under which they were made, not misleading. If, at any time prior to the Effective Time, any event or circumstance relating to the Company or any Company Subsidiary, or their respective officers or directors, should be discovered by the Company which should be set forth in an amendment or a supplement to the Registration Statement or the Proxy Statement, the Company shall promptly inform GigCapital5. All documents that the Company is responsible for filing with the SEC in connection with the Merger or the other transactions contemplated by this Agreement will comply as to form and substance in all material respects with the applicable requirements of the Securities Act and the rules and regulations thereunder and the Exchange Act and the rules and regulations thereunder.

(e) Without the prior written consent of the Company, the GigCapital5 Proposals shall be the only matters (other than procedural matters) which GigCapital5 shall propose to be acted on by GigCapital5 stockholders at the GigCapital5 Stockholders' Meeting.

**SECTION 7.02 GigCapital5 Stockholders' Meetings; and Merger Sub Stockholder's Approval.**

(a) GigCapital5 shall call and hold the GigCapital5 Stockholders' Meeting as promptly as practicable after the date on which the Registration Statement becomes effective for the purpose of voting solely upon the GigCapital5 Proposals, and GigCapital5 shall use its reasonable best efforts to hold the GigCapital5 Stockholders' Meeting as soon as practicable after the date on which the Registration Statement becomes effective (but in any event no later than 30 days after the date on which the Proxy Statement is mailed to stockholders of GigCapital5). GigCapital5 shall use its reasonable best efforts to obtain the approval of the GigCapital5 Proposals at the GigCapital5 Stockholders' Meeting, including by soliciting from its stockholders' proxies as promptly as possible in favor of the GigCapital5 Proposals, and shall take all other action necessary or advisable to secure the required vote or consent of its stockholders. The GigCapital5 Board shall recommend to its stockholders that they approve the GigCapital5 Proposals and shall include such recommendation in the Proxy Statement.

(b) Promptly following the execution of this Agreement, GigCapital5 shall approve and adopt this Agreement and approve the Merger and the other transactions contemplated by this Agreement, as the sole stockholder of Merger Sub.

**SECTION 7.03 Company Stockholders' Written Consent.** Upon the terms set forth in this Agreement, the Company shall deliver to the Company's stockholders (a) an information statement derived from the Proxy Statement seeking the irrevocable written consent, in form and substance reasonably acceptable to GigCapital5, of holders of the Requisite Approval (including the Key Company Stockholders) in favor of the approval and adoption of this Agreement and the Merger and all other transactions contemplated by this Agreement (the "Written Consent"), together with (b) the Registration Statement, as soon as reasonably practicable after the Registration Statement becomes effective, but no later than ten (10) Business Days prior to the GigCapital5 Stockholders' Meeting, provided, that the GigCapital5 Stockholders' Meeting is not held less than ten (10) Business Days after the Registration Statement is declared effective. The Company shall not send the Registration Statement prior to it being declared effective by the SEC to the stockholders of the Company, other than Key Company Stockholders which may be provided drafts of the Registration Statement by the Company.

**SECTION 7.04 Access to Information; Confidentiality.**

(a) From the date of this Agreement until the Effective Time, the Company and GigCapital5 shall (and shall cause their respective subsidiaries to): (i) provide to the other party (and the other party's officers, directors, employees, accountants, consultants, legal counsel, agents and other representatives, collectively, "Representatives") reasonable access at reasonable times upon prior notice to the officers, agents, properties, offices and other facilities of such party and its subsidiaries and to the books and records thereof; and (ii) furnish promptly to the other party such information concerning the business, properties, contracts, assets, liabilities, personnel and other aspects of such party and its subsidiaries as the other party or its Representatives may reasonably request. Notwithstanding the foregoing, neither the Company nor GigCapital5 shall be required to provide access to or disclose information where the access or disclosure would (i) jeopardize the protection of attorney-client privilege or contravene applicable Law including COVID-19 Measures or (ii) require providing access that such party reasonably determines, in light of COVID-19 or COVID-19 Measures, would jeopardize the health and safety of any employee of such party (it being agreed that the parties shall use their commercially reasonable efforts to cause such information to be provided in a manner that would not result in such jeopardy or contravention).

(b) All information obtained by the parties pursuant to this Section 7.04 shall be kept confidential in accordance with the confidentiality agreement, dated August 30, 2022 (the "Confidentiality Agreement"), between GigCapital5 and the Company.

(c) Notwithstanding anything in this Agreement to the contrary, each party (and its Representatives) may consult any tax advisor regarding the tax treatment and tax structure of the Transactions and may disclose to any other person, the tax treatment and tax structure of the Transactions and all materials (including opinions or other tax analyses) that are provided relating to such treatment or structure, in each case in accordance with the Confidentiality Agreement.

**SECTION 7.05** Exclusivity.

(a) From the date of this Agreement and ending on the earlier of (i) the Closing and/or (ii) the termination of this Agreement, the Company shall not, and shall cause its Representatives not to, directly or indirectly, (A) enter into, solicit, initiate or continue any discussions or negotiations with, or encourage or respond to any inquiries or proposals by, or participate in any negotiations with, or provide any information to, or otherwise cooperate in any way with, any person or other entity or “group” within the meaning of Section 13(d) of the Exchange Act, concerning (1) any sale of assets of the Company, (2) the issuance or acquisition of the outstanding capital stock (on an as converted to Company Common Stock basis) or other voting securities of the Company, or (3) any conversion, consolidation, merger, liquidation, dissolution or similar transaction (an “Alternative Transaction”), (B) enter into any agreement regarding, continue or otherwise participate in any discussions regarding, or furnish to any person any information with respect to, or cooperate in any way that would otherwise reasonably be expected to lead to, any Alternative Transaction, or (C) commence, continue or renew any due diligence investigation regarding any Alternative Transaction; provided, that the execution, delivery and performance of this Agreement and the Transaction Documents and the consummation of the transactions contemplated hereby shall not be deemed a violation of this Section 7.05(a). The Company shall, and shall cause its affiliates and Representatives to, immediately cease any and all existing discussions or negotiations with any person conducted heretofore with respect to any Alternative Transaction. The Company also agrees that it will promptly request each person (other than the parties hereto and their respective Representatives) that has prior to the date hereof executed a confidentiality agreement in connection with its, his or her consideration of acquiring the Company to return or destroy all Confidential Information furnished to such person by or on behalf of it, him, or her prior to the date hereof. If the Company or any of its Representatives receives any inquiry or proposal with respect to an Alternative Transaction at any time prior to the Closing, then the Company shall promptly (and in no event later than twenty-four (24) hours after the Company become aware of such inquiry or proposal) notify such person in writing that the Company is subject to an exclusivity agreement with respect to the sale of the Company that prohibits it from considering such inquiry or proposal, and will provide GigCapital5 with a copy of any such written inquiry or proposal or a detailed summary of any such verbal inquiry or proposal, including in each case the identity of the person making such inquiry or proposal. Without limiting the foregoing, the parties agree that any violation of the restrictions set forth in this Section 7.05(a) by the Company or its affiliates or Representatives shall be deemed to be a breach of this Section 7.05(a) by the Company.

(b) From and after the date hereof until the Effective Time or, if earlier, the termination of this Agreement, GigCapital5 shall not take, nor shall it permit any of its affiliates or Representatives to take, whether directly or indirectly, any action to solicit, initiate, continue or engage in discussions or negotiations with, or enter into any agreement with, or encourage, respond, provide information to or commence due diligence with respect to, any person (other than the Company, its stockholders and/or any of their affiliates or Representatives), concerning, relating to or which is intended or is reasonably likely to give rise to or result in, any offer, inquiry, proposal or indication of interest, written or oral relating to any business combination transaction (a “Business Combination Proposal”) other than with the Company, its stockholders and their respective affiliates and Representatives. GigCapital5 shall, and shall cause its affiliates and Representatives to, immediately cease any and all existing discussions or negotiations with any person (other than with the Company, its stockholders and their respective affiliates and Representatives) conducted prior to the date hereof with respect to, or which is reasonably likely to give rise to or result in, a Business Combination Proposal.

**SECTION 7.06 Employee Benefits Matters.** The parties shall cooperate to establish an equity incentive award plan for QTI Holdings with an award pool of GigCapital5 Common Stock equal to eleven percent (11%) of the fully diluted shares of GigCapital5 Common Stock outstanding as of immediately after the Effective Time (rounded up to the nearest whole share) (the “Initial Equity Plan Pool”), which plan shall include an “evergreen” provision pursuant to which such award pool will automatically increase on each January 1<sup>st</sup> that occurs within the ten year period following stockholder approval of such plan by an amount equal to five percent (5%) of the shares of GigCapital5 Common Stock outstanding as of 12:01 a.m. (Pacific Time) on such date, and which plan shall become effective upon, or as soon as practicable following, the Closing (the “Equity Plan”). The Equity Plan will provide that awards made pursuant to it by QTI Holdings may be in the form of options, stock appreciation rights, restricted stock awards, restricted stock units, performance shares, performance units, cash-based awards and other stock-based awards (the “Awards”). The parties expect that up to twenty-five percent (25%) of the Initial Equity Plan Pool would be reserved for issuance of Awards by QTI Holdings to individuals who were employees or other service providers of the Company as of the Closing, and remain continuously employed or engaged by QTI Holdings at the time of the issuance of such Awards following the Closing. GigCapital5 shall take all steps necessary to submit the Equity Plan for approval by the stockholders of GigCapital5 prior to Closing.

**SECTION 7.07 Directors’ and Officers’ Indemnification; Tail Insurance.**

(a) The certificate of incorporation and bylaws of the Surviving Corporation shall contain provisions no less favorable with respect to exculpation, indemnification, advancement of expenses or expense reimbursement existing in favor of the current or former directors and officers of Company than are set forth in the organizational documents of the Company, which provisions shall not be amended, repealed or otherwise modified for a period of six years from the Effective Time in any manner that would affect adversely the rights thereunder of individuals who, at or prior to the Effective Time, were directors or officers of the Company, unless such modification shall be required by applicable Law; provided, the foregoing shall only apply with regard to pre-Closing Date acts or omissions or matters by reason of pre-Closing Date service of such Persons. GigCapital5 further agrees that with respect to the provisions of the bylaws or limited liability company agreements of the Company Subsidiaries relating to exculpation, indemnification, advancement of expenses or expense reimbursement existing in favor of the current or former directors and officers of the Company Subsidiaries and each Person who served as a director, officer, manager, member, trustee or fiduciary of another corporation, partnership, joint venture, trust, pension or other employee benefit plan or enterprise at the request of the Company under any organizational documents, indemnification, employment or other similar agreements between any such Person and the Company, such provisions shall not be amended, repealed or otherwise modified for a period of six years from the Effective Time in any manner that would affect adversely the rights thereunder of individuals who, at or prior to the Effective Time, were directors, officers, managers, member, trustee or fiduciary of another corporation, partnership, joint venture, trust, pension or other employee benefit plan or enterprise of such Company Subsidiary, unless such modification shall be required by applicable Law; provided, the foregoing shall only apply with regard to pre-Closing Date acts or omissions or matters by reason of pre-Closing Date service of such Persons.

(b) For the benefit of the Company and the Company Subsidiaries’ directors and officers, the Company may prior to the Closing Date obtain and fully pay the premium for a “tail” insurance policy that provides coverage with respect to such entities for up to a six-year period from and after the Effective Time for events occurring prior to the Effective Time (the “Company D&O Tail Insurance”).

(c) After the Closing Date, QTI Holdings shall maintain director and officer insurance policies on behalf of its then current directors and officers of QTI Holdings, the Surviving Corporation and the other Company Subsidiaries, and QTI Holdings shall timely pay or caused to be paid all premiums with respect to such director and officer insurance policies.

(d) On the Closing Date, QTI Holdings shall enter into customary indemnification agreements reasonably satisfactory to each of the Company and GigCapital5 with the post-Closing directors and officers of GigCapital5, the Company and the Surviving Corporation, which indemnification agreements shall continue to be effective following the Closing.

(e) On and after the Closing Date, for a period of no less than six years, QTI Holdings shall maintain public company directors' and officers' liability insurance with full, continuous prior acts coverage for pre-Closing acts, errors, omissions, or claims based on the status, of GigCapital5's directors and officers (such insurance, together with the Company D&O Tail Insurance, the "Tail Policies"). Such coverage shall be at least the equivalent, including with respect to amount and coverage terms, as that provided under GigCapital5's public company D&O insurance just prior to Closing; for clarity, this requirement is satisfied by the purchase and maintenance of the extended reporting period on such coverage.

(f) On and after the Closing Date, for a period of no less than six years, QTI Holdings shall, with regard to pre-Closing acts, errors, omissions of GigCapital5 and the Company's directors and officers, respectively, maintain certificates of incorporation and bylaws with provisions no less favorable with respect to indemnification, advancement, expense reimbursement, and exculpation, than are set forth in the certificates of incorporation or bylaws of GigCapital5 and the Company, respectively, just prior to Closing.

(g) On and after the Closing Date, for a period of no less than six years, QTI Holdings agrees that it shall defend, indemnify and hold harmless the Sponsor, its affiliates, and their respective present and former directors and officers against any costs or expenses (including reasonable attorneys' fees), judgments, fines, losses, claims, damages or liabilities incurred in connection with any claim, action, suit, proceeding or investigation, whether civil, criminal, administrative or investigative, arising out of or pertaining to the transactions, actions, and investments contemplated by this Agreement or any Ancillary Agreements, whether asserted or claimed prior to, at or after the Closing, to the fullest extent permitted by applicable Law (including the advancing of expenses as incurred to the fullest extent permitted under applicable Law). Notwithstanding anything herein to the contrary, the parties expressly acknowledge and agree that Sponsor shall be an express third-party beneficiary of this Section 7.07(g).

**SECTION 7.08 Notification of Certain Matters.** The Company shall give prompt notice to GigCapital5, and GigCapital5 shall give prompt notice to the Company, of any event which a party becomes aware of between the date of this Agreement and the Closing (or the earlier termination of this Agreement in accordance with Article IX), the occurrence, or non-occurrence of which causes or would reasonably be expected to cause any of the conditions set forth in Article VIII to fail to be satisfied at the Closing.

**SECTION 7.09 Further Action; Reasonable Best Efforts**

(a) Upon the terms and subject to the conditions of this Agreement, each of the parties hereto shall use its reasonable best efforts to take, or cause to be taken, appropriate action, and to do, or cause to be done, such things as are necessary, proper or advisable under applicable Laws or otherwise to consummate and make effective the Transactions, including, without limitation, using its reasonable best efforts to obtain all permits, consents, approvals, authorizations, qualifications and orders of Governmental Authorities and parties to contracts with the Company and the Company Subsidiaries as set forth in Section 4.05 necessary for the consummation of the Transactions and to fulfill the conditions to the Merger. In case, at any time after the Effective Time, any further action is necessary or desirable to carry out the purposes of this Agreement, the proper officers and directors of each party shall use their reasonable best efforts to take all such action.

(b) Each of the parties shall keep each other apprised of the status of matters relating to the Transactions, including promptly notifying the other parties of any communication it or any of its affiliates receives from any Governmental Authority relating to the matters that are the subject of this Agreement and permitting the other parties to review in advance, and to the extent practicable consult about, any proposed communication by such party to any Governmental Authority in connection with the Transactions. No party



to this Agreement shall agree to participate in any meeting with any Governmental Authority in respect of any filings, investigation, or other inquiry unless it consults with the other parties in advance and, to the extent permitted by such Governmental Authority, gives the other parties the opportunity to attend and participate at such meeting. Subject to the terms of the Confidentiality Agreement, the parties will coordinate and cooperate fully with each other in exchanging such information and providing such assistance as the other parties may reasonably request in connection with the foregoing. Subject to the terms of the Confidentiality Agreement, the parties will provide each other with copies of all material correspondence, filings, or communications, including any documents, information and data contained therewith, between them or any of their Representatives, on the one hand, and any Governmental Authority or members of its staff, on the other hand, with respect to this Agreement and the Transactions contemplated hereby. No party shall take or cause to be taken any action before any Governmental Authority that is inconsistent with or intended to delay its action on requests for a consent or the consummation of the Transactions.

**SECTION 7.10 Public Announcements.** The initial press release relating to this Agreement shall be a joint press release the text of which has been agreed to by each of GigCapital5 and the Company. Thereafter, between the date of this Agreement and the Closing Date (or the earlier termination of this Agreement in accordance with Article IX) unless otherwise prohibited by applicable Law or the requirements of the Exchanges, as applicable, each of GigCapital5 and the Company shall each use its reasonable best efforts to consult with each other before issuing any press release or otherwise making any public statements with respect to this Agreement, the Merger or any of the other Transactions, and shall not issue any such press release or make any such public statement without the prior written consent of the other party. Furthermore, nothing contained in this Section 7.10 shall prevent GigCapital5 or the Company and/or its respective affiliates from furnishing customary or other reasonable information concerning the Transactions to their investors and prospective investors.

**SECTION 7.11 Tax Matters.**

(a) Each of GigCapital5, Merger Sub and the Company shall use their respective commercially reasonable efforts to cause the Merger to qualify, and agree not to, and not to permit or cause any of their affiliates or subsidiaries to, take any action which to its knowledge could reasonably be expected to prevent or impede the Merger from qualifying, as a reorganization within the meaning of Section 368(a) of the Code (and for purposes of any applicable state or local income Tax that follows the U.S. federal income Tax treatment). This Agreement is intended to constitute, and the parties hereto hereby adopt this Agreement as, a “plan of reorganization” within the meaning of Treasury Regulation Sections 1.368-2(g) and 1.368-3(a). Each of GigCapital5, Merger Sub and the Company shall report the Merger as a reorganization within the meaning of Section 368(a) of the Code unless otherwise required pursuant to a “determination” within the meaning of Section 1313(a) of the Code, including attaching the statement described in Treasury Regulations Section 1.368-3(a) on or with its Tax Return for the taxable year of the Merger. To the extent that the SEC or any other Governmental Authority may require that an opinion be provided at or prior to the Closing in respect of the disclosure of the Tax consequences of the Transactions, each of GigCapital5 and the Company will use its reasonable best efforts and reasonably cooperate with one another and their respective counsel in connection with the issuance to GigCapital5 or the Company of such opinion, as applicable, described above, including using reasonable best efforts to deliver to the relevant counsel certificates (dated as of the necessary date and signed by an officer of GigCapital5 or the Company, or their respective affiliates, as applicable) containing customary representations reasonably necessary or appropriate for such counsel to render such opinion. To the extent such opinion relates to GigCapital5 or any owners thereof, Tax advisors for GigCapital5 will provide any such opinion, and to the extent such opinion relates to the Company or any owners thereof, Tax advisors for the Company will provide any such opinion, in each case, to the extent reasonably possible subject to customary assumptions and limitations and consistent with such Tax advisor’s internal policies.

(b) Tax Matters Cooperation. Each of the parties to this Agreement shall (and shall cause their respective Affiliates to) reasonably cooperate, as and to the extent reasonably requested by another party, in connection with the filing of relevant Tax Returns, and any Tax proceeding, relating to the matters contemplated by this Section 7.11. Such cooperation shall include the retention and (upon the other party's request) the provision (with the right to make copies) of records and information reasonably relevant to any such Tax proceeding and making employees available on a mutually convenient basis to provide additional information and explanation of any material provided hereunder.

**SECTION 7.12 Stock Exchange Listing**. GigCapital5 will use its reasonable best efforts to cause the Per Share Merger Consideration issued in connection with the Transactions to be approved for listing on the Exchanges, as applicable, at Closing; provided that GigCapital5 shall require the prior written consent of the Company to change the listing of the Per Share Merger Consideration issued in connection with the Transactions from Nasdaq to the NYSE or NYSE American, or from the NYSE or NYSE American to Nasdaq, as applicable. During the period from the date hereof until the Closing, GigCapital5 shall use its reasonable best efforts to keep the GigCapital5 Units, GigCapital5 Common Stock, and GigCapital5 Warrants listed for trading on any of the Exchanges.

**SECTION 7.13 Antitrust**

(a) To the extent required under any Laws that are designed to prohibit, restrict, or regulate actions having the purpose or effect of monopolization or restraint of trade, including the HSR Act ("Antitrust Laws"), each party hereto agrees to promptly make any required filing or application under Antitrust Laws, as applicable. The parties hereto agree to supply as promptly as reasonably practicable any additional information and documentary material that may be requested pursuant to Antitrust Laws and to use commercially reasonable efforts to take any other actions necessary, proper or advisable to cause the expiration or termination of the applicable waiting periods or obtain required approvals, as applicable under Antitrust Laws as soon as reasonably practicable, including by requesting early termination of the waiting period provided for under the HSR Act.

(b) Each party shall, in connection with its efforts to obtain all requisite approvals and authorizations for the Transactions under any Antitrust Law, use its commercially reasonable efforts to: (i) cooperate in all respects with each other party or its affiliates in connection with any filing or submission and in connection with any investigation or other inquiry, including any proceeding initiated by a private person; (ii) keep the other parties reasonably informed of any communication received by such party or its Representatives from, or given by such party or its Representatives to, any Governmental Authority and of any communication received or given in connection with any proceeding by a private person, in each case regarding any of the Transactions; (iii) permit a Representative of the other parties and their respective outside legal counsel to review any communication given by it to, and consult with each other in advance of any meeting or conference with, any Governmental Authority or, in connection with any proceeding by a private person, with any other person, and to the extent permitted by such Governmental Authority or other person, give a Representative or Representatives of the other parties the opportunity to attend and participate in such meetings and conferences; (iv) in the event a party's Representative is prohibited from participating in or attending any meetings or conferences, the other parties shall keep such party promptly and reasonably apprised with respect thereto; and (v) use commercially reasonable efforts to cooperate in the filing of any memoranda, white papers, filings, correspondence or other written communications explaining or defending the Transactions, articulating any regulatory or competitive argument, and/or responding to requests or objections made by any Governmental Authority.

(c) No party hereto shall take any action that could reasonably be expected to adversely affect or materially delay the approval of any Governmental Authority of any required filings or applications under Antitrust Laws. The parties hereto further covenant and agree, with respect to a threatened or pending preliminary or permanent injunction or other order, decree or ruling or statute, rule, regulation or executive order that would adversely affect the ability of the parties to consummate the Transactions, to use

commercially reasonable efforts to prevent or lift the entry, enactment or promulgation thereof, as the case may be.

**SECTION 7.14 PCAOB Financial Statements.** The Company shall use reasonable best efforts to deliver: (a) not later than 45 days from the date hereof, true and complete copies of (i) the audited consolidated financial statements of the Company and the Company Subsidiaries for the twelve (12) month periods ended December 31, 2021, and (ii) the reviewed financial statements of the Company and the Company Subsidiaries for the nine (9) month period ended September 30, 2022 (collectively, the “Initial PCAOB Financial Statements”), and (b) as soon as possible but in any event not later than March 15, 2023, true and complete copies of the audited consolidated financial statements of the Company and the Company Subsidiaries for the twelve (12) month period ended December 31, 2022; each audited or reviewed, as applicable, by a U.S. accounting firm registered with the PCAOB (collectively with the Initial PCAOB Financial Statements, the “PCAOB Financial Statements”).

**SECTION 7.15 Trust Account.** As of the Effective Time, the obligations of GigCapital5 to dissolve or liquidate within a specified time period as contained in GigCapital5’s Certificate of Incorporation will be terminated and GigCapital5 shall have no obligation whatsoever to dissolve and liquidate the assets of GigCapital5 by reason of the consummation of the Merger or otherwise, and no stockholder of GigCapital5 shall be entitled to receive any amount from the Trust Account. At least 48 hours prior to the Effective Time, GigCapital5 shall provide notice to the Trustee in accordance with the Trust Agreement and shall deliver any other documents, opinions or notices required to be delivered to the Trustee pursuant to the Trust Agreement and cause the Trustee prior to the Effective Time to, and the Trustee shall thereupon be obligated to, transfer all funds held in the Trust Account to GigCapital5 (to be held as available cash on the balance sheet of GigCapital5, and to be used for working capital and other general corporate purposes of the business following the Closing) and thereafter shall cause the Trust Account and the Trust Agreement to terminate.

**SECTION 7.16 Section 16 Matters.** Prior to the Closing, GigCapital5 shall take all such steps as may be required (to the extent permitted under applicable Law and no-action letters issued by the SEC) to cause any acquisition of GigCapital5 Common Stock by each individual who is or will be subject to the reporting requirements of Section 16(a) of the Exchange Act with respect to the Surviving Corporation, to be exempt under Rule 16b-3 under the Exchange Act. GigCapital5 shall provide such individuals with copies of any resolutions proposed to be adopted by the GigCapital5 Board in connection with the foregoing prior to such adoption.

**SECTION 7.17 Company Warrants.** Prior to the Closing, pursuant to GigCapital5 informing the Company that all out-of-the-money Company Warrants would not be assumed by QTI Holdings and should be canceled as a condition to the consummation of the business combination, the Company shall use reasonable best efforts pursuant to Sections 3(c) and (d) of the Company Warrant agreement to (a) comply with all notice and other provisions of the Company Warrants and (b) take such actions as are necessary or advisable, including obtaining any elections, amendments, consents and waivers from the holders of Company Warrants, in order to cause (i) the Company Warrants (other than In-the-Money Company Warrants) to be cancelled without consideration upon the Closing pursuant to the provisions of Section 3.01(c), and (ii) the In-the-Money Company Warrants to be exercised for shares of Company Common Stock prior to the Closing, or assumed by GigCapital5 upon the Closing pursuant to the provisions of Section 3.01(c).

**SECTION 7.18 Company Convertible Notes.** Prior to the Closing, the Company shall use reasonable best efforts to comply with all notice and other provisions of the Company Convertible Notes. Furthermore, prior to the Closing, the Company shall take such actions as are necessary or advisable, including obtaining any elections, amendments, consents and waivers from the holders of Converting Notes, in order to cause (a) the Converting Notes to be converted into Company Common Stock and (b) for all liens and security interests granted in favor of the holders of such Converting Notes to be terminated, each immediately prior to the Effective Time. With respect to the Surviving Notes, at the Closing, Surviving Notes with an aggregate principal amount of up to \$200,000 will be repaid by QTI Holdings, and the other Surviving Notes will be amended to provide that they

will be notes of QTI Holdings that are repayable in cash at the maturity date stated in such Surviving Notes for the principal amounts stated in such Surviving Notes plus accruing interest at the interest rate stated in such Surviving Notes, but that are not convertible into shares or other securities of any entity, and are senior in right (subject to any debt financing obtained pursuant to [Section 7.20](#) and after repayment at the Closing of the debts of GigCapital5 stated in the GigCapital5 SEC Reports) but are not subject to a lien or security interest, and that all liens and security interest currently granted in favor of the holders of such Surviving Notes will be terminated as of the Closing.

**SECTION 7.19 Insurance.**

(a) The parties acknowledge that GigCapital5 has obtained the R&W Insurance Policy subject to a conditional binder, and that GigCapital5 will pay the required fees, costs and expenses of the R&W Insurance Provider at such times as required by the R&W Insurance Policy and the conditional binder (and all such fees, costs, and expenses shall be considered Unpaid GigCapital5 Transaction Expenses). The Company shall, and shall cause its representatives to, cooperate with the R&W Insurance Provider and GigCapital5 and provide all information or take such other action as the R&W Insurance Provider or GigCapital5 may reasonably request in connection with finalizing, binding or issuing the R&W Insurance Policy, including by participating in any due diligence bring down call requested by the R&W Insurance Provider.

(b) Pursuant to Section 7.07(b) and prior to the Closing Date, the Company will bind the Tail Policies (and all such fees, costs and expenses associated with such Tail Policies shall be considered Unpaid Company Transaction Expenses).

**SECTION 7.20 Financing.** From and after the execution and delivery of this Agreement through the Closing, GigCapital5 shall use its reasonable best efforts to arrange and obtain, and the Company shall use its reasonable best efforts to cooperate with and assist GigCapital5 in arranging and obtaining, up to \$26,000,000 of equity and/or debt financing for GigCapital5, including in the form of convertible promissory notes to be issued by GigCapital5 at the Closing, on terms and conditions mutually agreeable to GigCapital5 and the Company (such agreement not to be unreasonably withheld, conditioned or delayed).

**ARTICLE VIII.  
CONDITIONS TO THE MERGER**

**SECTION 8.01 Conditions to the Obligations of Each Party.** The obligations of the Company, GigCapital5 and Merger Sub to consummate the Transactions, including the Merger, are subject to the satisfaction or written waiver (where permissible) by the Company and GigCapital5 at or prior to the Closing of the following conditions:

(a) Written Consent. The Written Consent shall have been delivered to GigCapital5.

(b) GigCapital5 Stockholders' Approval. The GigCapital5 Proposals shall have been approved and adopted by the requisite affirmative vote of the stockholders of GigCapital5 in accordance with the Proxy Statement, the DGCL, the GigCapital5 Organizational Documents and the rules and regulations of the Exchanges.

(c) No Order. No Governmental Authority with competent jurisdiction shall have enacted, issued, promulgated, enforced or entered any Law, rule, regulation, judgment, decree, executive order, or award which is then in effect and has the effect of making the Transactions, including the Merger, illegal or otherwise prohibiting consummation of the Transactions, including the Merger.

(d) Antitrust Approvals and Waiting Periods. All required filings under the HSR Act shall have been completed and any applicable waiting period (and any extension thereof) applicable to the consummation of

the Transactions under the HSR Act shall have expired or been terminated, and any pre-Closing approvals or clearances reasonably required thereunder shall have been obtained.

(e) Consents. All consents, approvals and authorizations set forth on Schedule 4.05(a) of the Company Disclosure Schedule shall have been obtained from and made with all Governmental Authorities.

(f) Registration Statement. The Registration Statement shall have been declared effective under the Securities Act. No stop order suspending the effectiveness of the Registration Statement shall be in effect, and no proceedings for purposes of suspending the effectiveness of the Registration Statement shall have been initiated or be threatened by the SEC.

(g) Stock Exchange Listing. The shares of GigCapital5 Common Stock shall be listed on an Exchange as of the Closing Date.

(h) Net Tangible Assets Test. Upon the Closing, and after giving effect to the Redemption Rights, GigCapital5 shall have net tangible assets of at least \$5,000,001 (excluding assets of the Surviving Corporation).

**SECTION 8.02 Conditions to the Obligations of GigCapital5 and Merger Sub.** The obligations of GigCapital5 and Merger Sub to consummate the Transactions, including the Merger, are subject to the satisfaction or written waiver by GigCapital5 (where permissible) at or prior to the Closing of the following additional conditions:

(a) Representations and Warranties. The representations and warranties of the Company contained in Section 4.01 (Organization and Qualification; Subsidiaries), Section 4.03 (Capitalization), Section 4.04 (Authority Relative to this Agreement) and Section 4.23 (Brokers) shall each be true and correct in all material respects as of the Closing Date as though made on the Closing Date (without giving effect to any limitation as to “materiality” or “Company Material Adverse Effect” or any similar limitation set forth therein), except to the extent that any such representation and warranty expressly speaks as of an earlier date, in which case such representation and warranty shall be true and correct in all material respects as of such earlier date. All other representations and warranties of the Company contained in this Agreement shall be true and correct (without giving any effect to any limitation as to “materiality” or “Company Material Adverse Effect” or any similar limitation set forth therein) in all respects as of the Closing Date, as though made on and as of the Closing Date, except (i) to the extent that any such representation and warranty expressly speaks as of an earlier date, in which case such representation and warranty shall be true and correct as of such earlier date and (ii) where the failure of such representations and warranties to be true and correct (whether as of the Closing Date or such earlier date), taken as a whole, does not result in a Company Material Adverse Effect.

(b) Agreements and Covenants. The Company shall have performed or complied in all material respects with all agreements and covenants required by this Agreement to be performed, or complied with by it on or prior to the Effective Time.

(c) Officer Certificate. The Company shall have delivered to GigCapital5 a certificate, dated the date of the Closing, signed by an officer of the Company, certifying as to the satisfaction of the conditions specified in Section 8.02(a), Section 8.02(b), and Section 8.02(d).

(d) Material Adverse Effect. No Company Material Adverse Effect shall have occurred between the date of this Agreement and the Closing Date.

(e) Resignation. Other than those persons identified as continuing directors as per Section 2.05 hereof, all members of the Company Board and the Board of Directors of the Company Subsidiaries shall have executed written resignations effective as of the Effective Time.

(f) Stockholder Support Agreement. The Stockholder Support Agreement shall be in full force and effect on the Closing Date, and no Key Company Stockholder shall have attempted to repudiate or disclaim any of its or his/her obligations thereunder.

(g) Registration Rights Agreement. All parties to the Registration Rights Agreement (other than GigCapital5) shall have delivered, or cause to be delivered, to GigCapital5 copies of the Registration Rights Agreement duly executed by all such parties.

(h) Lock-Up Agreement. The Company has delivered, or has caused to be delivered, to GigCapital5 the Lock-Up Agreement duly executed by each holder of shares of Company Common Stock outstanding as of immediately prior to the Effective Time, other than any such holder who, as of immediately prior to the Effective Time, owns (together with his, her or its Affiliates) an aggregate of less than three percent (3%) of all shares of Company Common Stock then outstanding.

(i) FIRPTA Tax Certificates. On or prior to the Closing, the Company shall deliver to GigCapital5 a properly executed certification that shares of Company Common Stock are not "U.S. real property interests" in accordance with the Treasury Regulations under Sections 897 and 1445 of the Code, together with a notice to the IRS (which shall be filed by GigCapital5 with the IRS following the Closing) in accordance with the provisions of Section 1.897-2(h)(2) of the Treasury Regulations.

(j) PCAOB Financial Statements. The Company shall have delivered to GigCapital5 the PCAOB Financial Statements.

(k) Company Warrants. The Company Warrants (other than In-the-Money Company Warrants) shall have been amended such that such Company Warrants shall be canceled without consideration upon the Closing pursuant to Section 3.01(c). The In-the-Money Company Warrants shall have been canceled, extinguished and exercised for shares of Company Common Stock in accordance with their terms, or shall be capable of being assumed by GigCapital5 in accordance with their terms and the provisions of Section 3.01(c).

(l) Company Convertible Notes. The Converting Notes shall have been converted into Company Common Shares immediately prior to the Effective Time and the Surviving Notes shall have been repaid or amended consistent with the provisions of Section 7.18 and otherwise in form and substance reasonably satisfactory to GigCapital5.

(m) Company Closing Debt. The Company Closing Debt shall be no more than \$4,000,000.

(n) Transaction Documents. The Transaction Documents shall be in full force and effect and shall not have been rescinded by the Company.

**SECTION 8.03 Conditions to the Obligations of the Company.** The obligations of the Company to consummate the Transactions, including the Merger, are subject to the satisfaction or written waiver by the Company (where permissible) at or prior to Closing of the following additional conditions:

(a) Representations and Warranties. The representations and warranties of GigCapital5 and Merger Sub contained in Section 5.01 (Corporation Organization), Section 5.03 (Capitalization), Section 5.04 (Authority Relative to this Agreement), and Section 5.12 (Brokers) shall each be true and correct in all material respects as of the Closing Date as though made on the Closing Date (without giving effect to any limitation as to "materiality" or "GigCapital5 Material Adverse Effect" or any similar limitation set forth therein), except to the extent that any such representation and warranty expressly speaks as of an earlier date, in which case such representation and warranty shall be true and correct in all material respects as of such earlier date. All other representations and warranties of GigCapital5 and Merger Sub contained in this Agreement shall be true and correct (without giving any effect to any limitation as to "materiality" or "GigCapital5 Material Adverse Effect" or any similar limitation set forth therein) in all respects as of the Closing Date, as though made on and as of the Closing Date, except (i) to the extent that any such representation and warranty expressly speaks as of an earlier date, in which case such representation and warranty shall be true and correct as of such earlier date and (ii) where the failure of such representations and warranties to be true and correct (whether as of the Closing Date or such earlier date), taken as a whole, does not result in a GigCapital5 Material Adverse Effect.

(b) Agreements and Covenants. GigCapital5 and Merger Sub shall have performed or complied in all material respects with all agreements and covenants required by this Agreement to be performed, or complied with, by it on or prior to the Effective Time.

(c) Officer Certificate. GigCapital5 shall have delivered to the Company a certificate, dated the date of the Closing, signed by the President of GigCapital5, certifying as to the satisfaction of the conditions specified in Section 8.03(a), Section 8.03(b), and Section 8.03(d).

(d) Material Adverse Effect. No GigCapital5 Material Adverse Effect shall have occurred between the date of this Agreement and the Closing Date which is continuing and uncured.

(e) Minimum Proceeds. The Available Cash shall be equal or greater than \$15,000,000.

(f) Board Composition. GigCapital5 shall have taken all such actions as reasonable required such that, immediately following the Closing, the QTI Holdings Board shall consist of the directors as indicated in Section 2.05.

(g) Current and Long-Term Liabilities. All current and long-term liabilities of GigCapital5 shall, immediately prior to the Closing, be capable of being satisfied as part of the Unpaid GigCapital5 Transaction Expenses.

(h) Stock Exchange Listing. A supplemental listing shall have been filed with an Exchange, as applicable, as of the Closing Date to list the shares constituting the Aggregate Closing Merger Consideration.

(i) Registration Rights Agreement. GigCapital5 shall have delivered a copy of the Registration Rights Agreement duly executed by GigCapital5 and the Sponsor.

(j) Lock-Up Agreement. GigCapital5 shall have delivered a copy of the Lock-Up Agreement duly executed by GigCapital5 and the Sponsor.

(k) Sponsor Support Agreement. The transactions contemplated by the Sponsor Support Agreement to occur at or prior to the Closing shall have been consummated in accordance with the terms of the Sponsor Support Agreement.

(l) Transaction Documents. The Transaction Documents shall be in full force and effect and shall not have been rescinded by GigCapital5 or Merger Sub.

#### **ARTICLE IX. TERMINATION, AMENDMENT AND WAIVER**

**SECTION 9.01 Termination**. This Agreement may be terminated, and the Merger and the other Transactions may be abandoned at any time prior to the Effective Time, notwithstanding any requisite approval and adoption of this Agreement and the Transactions by the stockholders of the Company or GigCapital5, as follows:

(a) by mutual written consent of GigCapital5 and the Company; or

(b) by written notice by either GigCapital5 or the Company if the Effective Time shall not have occurred prior to the date that is nine (9) months following the date of this Agreement (the "Outside Date"); provided, however, that this Agreement may not be terminated under this Section 9.01(b) by or on behalf of any party that either directly or indirectly through its affiliates is in breach or violation of any representation, warranty, covenant, agreement or obligation contained herein and such breach or violation is the principal cause of the failure of a condition set forth in Article VIII on or prior to the Outside Date; or

(c) by written notice by either GigCapital5 or the Company if any Governmental Authority of competent jurisdiction in the United States shall have enacted, issued, promulgated, enforced, or entered any

injunction, order, decree or ruling (whether temporary, preliminary or permanent) which has become final and nonappealable and has the effect of making consummation of the Transactions, including the Merger, illegal or otherwise preventing or prohibiting consummation of the Transactions or the Merger; or

(d) by written notice by either GigCapital5 or the Company to the other party, if any of the GigCapital5 Proposals shall fail to receive the requisite vote for approval at the GigCapital5 Stockholders' Meeting; or

(e) by written notice by GigCapital5 to the Company, if the Company shall have failed to deliver the Written Consent to GigCapital5; or

(f) by written notice by GigCapital5 to the Company upon a breach of any representation, warranty, covenant or agreement on the part of the Company set forth in this Agreement, or if any representation or warranty of the Company shall have become untrue, in either case such that the conditions set forth in Sections 8.02(a) and 8.02(b) would not be satisfied ("Terminating Company Breach"); provided that GigCapital5 has not waived such Terminating Company Breach and GigCapital5 and Merger Sub are not then in material breach of their representations, warranties, covenants or agreements in this Agreement; provided further that, if such Terminating Company Breach is curable by the Company, GigCapital5 may not terminate this Agreement under this Section 9.01(f) for so long as the Company continues to exercise its reasonable efforts to cure such breach, unless such breach is not cured within thirty (30) days after notice of such breach is provided by GigCapital5 to the Company; or

(g) by written notice by the Company to GigCapital5 upon a breach of any representation, warranty, covenant or agreement on the part of GigCapital5 or Merger Sub set forth in this Agreement, or if any representation or warranty of GigCapital5 or Merger Sub shall have become untrue, in either case such that the conditions set forth in Sections 8.03(a) and 8.03(b) would not be satisfied ("Terminating GigCapital5 Breach"); provided that the Company has not waived such Terminating GigCapital5 Breach and the Company is not then in material breach of their representations, warranties, covenants or agreements in this Agreement; provided, however, that, if such Terminating GigCapital5 Breach is curable by GigCapital5 and Merger Sub, the Company may not terminate this Agreement under this Section 9.01(g) for so long as GigCapital5 and Merger Sub continue to exercise their reasonable efforts to cure such breach, unless such breach is not cured within thirty (30) days after notice of such breach is provided by the Company to GigCapital5; or

(h) by written notice by either GigCapital5 or the Company to the other party, if the condition set forth in Section 8.01(h) has not been satisfied.

**SECTION 9.02 Effect of Termination.** In the event of the termination of this Agreement pursuant to written notice in Section 9.01 which shall set forth the basis of such termination including the provision of Section 9.01 under which such termination is made, this Agreement shall forthwith become void, and there shall be no liability under this Agreement on the part of any party hereto, and all rights and obligations of each party shall cease, except as set forth in Section 7.04, this Section 9.02, Section 9.03, Article X, and any corresponding definitions set forth in Article I, or in the case of termination subsequent to a willful material breach of this Agreement by a party hereto.

**SECTION 9.03 Expenses.** Except as set forth in this Section 9.03 or elsewhere in this Agreement, all expenses incurred in connection with this Agreement and the Transactions shall be paid by the party incurring such expenses, whether or not the Merger or any other Transaction is consummated, except that GigCapital5 and the Company shall each pay one-half of all expenses relating to the filing fee for the Notification and Report Forms filed under the HSR Act (and, for the avoidance of doubt, such expenses paid by GigCapital5 and the Company shall be Paid GigCapital5 Transaction Expenses and Paid Company Transaction Expenses, respectively).

**SECTION 9.04 Amendment.** This Agreement may be amended in writing by the parties hereto at any time prior to the Effective Time. This Agreement may not be amended except by an instrument in writing signed by each of the parties hereto.



**SECTION 9.05 Waiver.** At any time prior to the Effective Time, (a) GigCapital5 may (i) extend the time for the performance of any obligation or other act of the Company, (ii) waive any inaccuracy in the representations and warranties of the Company contained herein or in any document delivered by the Company pursuant hereto, and (iii) waive compliance with any agreement of the Company or any condition to its own obligations contained herein and (b) the Company may (i) extend the time for the performance of any obligation or other act of GigCapital5 or Merger Sub, (ii) waive any inaccuracy in the representations and warranties of GigCapital5 or Merger Sub contained herein or in any document delivered by GigCapital5 and/or Merger pursuant hereto, and (iii) waive compliance with any agreement of GigCapital5 or Merger Sub or any condition to its own obligations contained herein. Any such extension or waiver shall be valid if set forth in an instrument in writing signed by the party or parties to be bound thereby.

**ARTICLE X.  
GENERAL PROVISIONS**

**SECTION 10.01 Notices.** All notices, requests, claims, demands and other communications hereunder shall be in writing and shall be given (and shall be deemed to have been duly given upon receipt) by delivery in person, by email or by registered or certified mail (postage prepaid, return receipt requested) to the respective parties at the following addresses (or at such other address for a party as shall be specified in a notice given in accordance with this Section 10.01):

if to GigCapital5 or Merger Sub at or prior to the Closing, to:

GigCapital5, Inc.  
1731 Embarcadero Road, Suite 200  
Palo Alto, CA 94303  
Attention: Dr. Raluca Dinu, President and Chief Executive Officer  
Dr. Avi S. Katz, Executive Chairman of the Board  
Email: \*\*\*

with a copy (which will not constitute notice) to:

DLA Piper LLP (US)  
555 Mission Street  
Suite 2400  
San Francisco, CA 94105  
Attention: Jeffrey Selman; John Maselli  
Email: [jeffrey.selman@us.dlapiper.com](mailto:jeffrey.selman@us.dlapiper.com); [john.maselli@us.dlapiper.com](mailto:john.maselli@us.dlapiper.com)

If to the Company at or prior to the Closing, to:

QT Imaging, Inc.  
3 Hamilton Landing  
Suite 160  
Novato, CA 94949  
Attention: Dr. John C. Klock, Chief Executive Officer  
Email: \*\*\*

with a copy (which will not constitute notice) to:

Seyfarth Shaw LLP  
975 F. Street NW  
Washington, DC 20004  
Attention: Andrew J. Sherman  
Facsimile No.: 202 828-5393  
Telephone No.: 202 828 5381  
E-mail: [asherman@seyfarth.com](mailto:asherman@seyfarth.com)

if to QTI Holdings or the Surviving Corporation post-Closing, to

QT Imaging Holdings, Inc.  
3 Hamilton Landing  
Suite 160  
Novato, CA 94949  
Attention: Dr. John C. Klock, Chief Executive Officer  
Email: \*\*\*

with a copy (which will not constitute notice) to:

Seyfarth Shaw LLP  
975 F. Street NW  
Washington, DC 20004  
Attention: Andrew J. Sherman  
Facsimile No.: 202 828-5393  
Telephone No.: 202 828 5381  
E-mail: [asherman@seyfarth.com](mailto:asherman@seyfarth.com)

and

with a copy (which will not constitute notice) to:

DLA Piper LLP (US)  
555 Mission Street  
Suite 2400  
San Francisco, CA 94105  
Attention: Jeffrey Selman; John Maselli  
Email: [jeffrey.selman@us.dlapiper.com](mailto:jeffrey.selman@us.dlapiper.com); [john.maselli@us.dlapiper.com](mailto:john.maselli@us.dlapiper.com)

**SECTION 10.02 Non-survival of Representations, Warranties and Covenants.** None of the representations, warranties, covenants, obligations or other agreements in this Agreement or in any certificate, statement or instrument delivered pursuant to this Agreement, including any rights arising out of any breach of such representations, warranties, covenants, obligations, agreements and other provisions, shall survive the Closing and all such representations, warranties, covenants, obligations or other agreements shall terminate and expire upon the occurrence of the Closing (and there shall be no liability after the Closing in respect thereof), except for (a) the sole purpose of recovery under the R&W Insurance Policy, (b) those covenants and agreements contained herein that by their terms expressly apply in whole or in part after the Closing and then only with respect to any breaches occurring after the Closing, (c) this Article X and any corresponding definitions set forth in Article I, and (d) any rights of GigCapital5 to seek and obtain recovery of damages arising out of or relating to Fraud, which rights shall in no event expire or be terminated, waived, or otherwise affected by operation of this Section 10.02.

**SECTION 10.03 Severability.** If any term or other provision of this Agreement is invalid, illegal, or incapable of being enforced by any rule of law, or public policy, all other conditions and provisions of this Agreement shall nevertheless remain in full force and effect so long as the economic or legal substance of the Transactions is not affected in any manner materially adverse to any party. Upon such determination that any term or other provision is invalid, illegal or incapable of being enforced, the parties hereto shall negotiate in good faith to modify this Agreement so as to effect the original intent of the parties as closely as possible in a mutually acceptable manner in order that the Transactions be consummated as originally contemplated to the fullest extent possible.

**SECTION 10.04 Entire Agreement; Assignment.** This Agreement and the Ancillary Agreements constitute the entire agreement among the parties with respect to the subject matter hereof and supersede, except as set forth in Section 7.04(b), all prior agreements, and undertakings, both written and oral, among the parties, or any of them, with respect to the subject matter hereof, except for the Confidentiality Agreement. This Agreement shall not be assigned (whether pursuant to a merger, by operation of law or otherwise) by any party without the prior express written consent of the other parties hereto.

**SECTION 10.05 Parties in Interest.** This Agreement shall be binding upon and inure solely to the benefit of each party hereto, and nothing in this Agreement, express or implied, is intended to or shall confer upon any other person any right, benefit, or remedy of any nature whatsoever under or by reason of this Agreement, other than Section 7.07 (which is intended to be for the benefit of the persons covered thereby and may be enforced by such persons).

**SECTION 10.06 Governing Law.** This Agreement shall be governed by and construed in accordance with the laws of the State of Delaware, without regard to any conflict of law rule or principle that would result in the application of any laws other than the laws of the State of Delaware. All Actions arising out of or relating to this Agreement shall be heard and determined exclusively in the Court of Chancery of the State of Delaware or, if such court declines to exercise jurisdiction or if subject matter jurisdiction over the matter that is the subject of any such legal action or proceeding is vested exclusively in the U.S. federal courts, the U.S. District Court for the District of Delaware. The parties hereto hereby (a) irrevocably submit to the exclusive jurisdiction of the aforesaid courts for themselves and with respect to their respective properties for the purpose of any Action arising out of or relating to this Agreement brought by any party hereto, and (b) agree not to commence any Action relating thereto except in the courts described above in Delaware, other than Actions in any court of competent jurisdiction to enforce any judgment, decree or award rendered by any such court in Delaware as described herein. Each of the parties further agrees that notice as provided herein shall constitute sufficient service of process and the parties further waive any argument that such service is insufficient. Each of the parties hereby irrevocably and unconditionally waives, and agrees not to assert, by way of motion or as a defense, counterclaim or otherwise, in any Action arising out of or relating to this Agreement or the transactions contemplated hereby, (a) any claim that it is not personally subject to the jurisdiction of the courts in Delaware as described herein for any reason, (b) that it or its property is exempt or immune from jurisdiction of any such court or from any legal process commenced in such courts (whether through service of notice, attachment prior to judgment, attachment in aid of execution of judgment, execution of judgment or otherwise), and (c) that (i) the Action in any such court is brought in an inconvenient forum, (ii) the venue of such Action is improper or (iii) this Agreement, or the subject matter hereof, may not be enforced in or by such courts.

**SECTION 10.07 WAIVER OF JURY TRIAL.** EACH OF THE PARTIES HERETO HEREBY WAIVES TO THE FULLEST EXTENT PERMITTED BY APPLICABLE LAW ANY RIGHT IT MAY HAVE TO A TRIAL BY JURY WITH RESPECT TO ANY LITIGATION DIRECTLY OR INDIRECTLY ARISING OUT OF, UNDER OR IN CONNECTION WITH THIS AGREEMENT OR THE TRANSACTIONS. EACH OF THE PARTIES HERETO (A) CERTIFIES THAT NO REPRESENTATIVE, AGENT OR ATTORNEY OF ANY OTHER PARTY HAS REPRESENTED, EXPRESSLY OR OTHERWISE, THAT SUCH OTHER PARTY WOULD NOT, IN THE EVENT OF LITIGATION, SEEK TO ENFORCE THAT FOREGOING WAIVER AND (B) ACKNOWLEDGES THAT IT AND THE OTHER HERETO HAVE BEEN INDUCED TO ENTER

INTO THIS AGREEMENT AND THE TRANSACTIONS, AS APPLICABLE, BY, AMONG OTHER THINGS, THE MUTUAL WAIVERS AND CERTIFICATIONS IN THIS SECTION 10.07.

**SECTION 10.08 Headings**. The descriptive headings contained in this Agreement are included for convenience of reference only and shall not affect in any way the meaning or interpretation of this Agreement.

**SECTION 10.09 Counterparts**. This Agreement may be executed and delivered (including by facsimile or portable document format (pdf) transmission) in one or more counterparts, and by the different parties hereto in separate counterparts, each of which when executed shall be deemed to be an original but all of which taken together shall constitute one and the same agreement.

**SECTION 10.10 Non-Recourse**(i). This Agreement may only be enforced against, and any claim or cause of action based upon, arising out of, or related to this Agreement or the Transactions may only be brought against, the parties, and then only with respect to the specific obligations set forth herein or in the other Transaction Documents with respect to such party. Except to the extent a party to this Agreement or the other Transaction Documents and then only to the extent of the specific obligations undertaken by such party in this Agreement or in the applicable Ancillary Agreement, (a) no past, present or future director, officer, employee, incorporator, member, partner, stockholder, affiliate, agent, attorney, advisor or representative or affiliate of any party to this Agreement or any other Transaction Documents, and (b) no past, present or future director, officer, employee, incorporator, member, partner, stockholder, affiliate, agent, attorney, advisor or Representative or affiliate of any of the foregoing shall have any liability (whether in contract, tort, equity or otherwise) for any one or more of the representations, warranties, covenants, agreements or other obligations or liabilities of any one or more of the Company, GigCapital5, or Merger Sub under this Agreement or any other Transaction Document of or for any claim based on, arising out of, or related to this Agreement or the Transactions.

**SECTION 10.11 Specific Performance**. The parties agree that irreparable damage would occur if any provision of this Agreement were not performed in accordance with the terms hereof, and, accordingly, that the parties shall be entitled to an injunction or injunctions to prevent breaches of this Agreement or to enforce specifically the performance of the terms and provisions hereof (including the parties' obligation to consummate the Merger) in accordance with the provisions of Section 10.06 without proof of actual damages or otherwise, in addition to any other remedy to which they are entitled at law or in equity as expressly permitted in this Agreement. Each of the parties hereby further waives (a) any defense in any action for specific performance that a remedy at law would be adequate and (b) any requirement under any Law to post security or a bond as a prerequisite to obtaining equitable relief.

*[Signature Page Follows.]*

IN WITNESS WHEREOF, GigCapital5, Merger Sub, and the Company have caused this Agreement to be executed as of the date first written above by their respective officers thereunto duly authorized.

GIGCAPITAL5, INC.

By /s/ Dr. Raluca Dinu  
Name: Dr. Raluca Dinu  
Title: Chief Executive Officer

QTI MERGER SUB, INC.

By /s/ Dr. Raluca Dinu  
Name: Dr. Raluca Dinu  
Title: Chief Executive Officer

QT IMAGING, INC.

By /s/ Dr. John Klock  
Name: Dr. John Klock  
Title: Chief Executive Officer

*[Signature Page to Business Combination Agreement]*

## EXHIBIT A

### SPONSOR SUPPORT AGREEMENT

This SPONSOR SUPPORT AGREEMENT (this "Agreement"), dated as of December 8, 2022, is entered into by and among GigAcquisitions5, LLC, a Delaware limited liability company (the "Sponsor"), GigCapital5, Inc., a Delaware corporation ("GigCapital5"), and QT Imaging, Inc., a Delaware corporation (the "Company").

### RECITALS

**WHEREAS**, concurrently herewith, the Company, QTI Merger Sub, Inc., a Delaware corporation ("Merger Sub"), and GigCapital5 are entering into a Business Combination Agreement (as amended, supplemented, restated or otherwise modified from time to time, the "BCA"), pursuant to which (and subject to the terms and conditions set forth therein) Merger Sub will merge with and into the Company (the "Merger"), with the Company surviving the Merger as a wholly owned subsidiary of GigCapital5;

**WHEREAS**, capitalized terms used but not otherwise defined in this Agreement shall have the meanings ascribed to them in the BCA;

**WHEREAS**, the Sponsor is currently the record owner of 6,530,000 shares of GigCapital5 Common Stock (the "Sponsor Shares"); and

**WHEREAS**, as a condition and inducement to the willingness of GigCapital5 and the Company to enter into the BCA, GigCapital5, the Company and the Sponsor are entering into this Agreement.

### AGREEMENT

**NOW, THEREFORE**, in consideration of the foregoing and the mutual covenants and agreements set forth herein, and for other good and valuable consideration, the receipt and sufficiency of which are hereby acknowledged, and intending to be legally bound hereby, the Sponsor, GigCapital5 and the Company hereby agree as follows:

1. Voting Agreement. The Sponsor agrees that, at the GigCapital5 Stockholders' Meeting, at any other meeting of the stockholders of GigCapital5 (whether annual or special and whether or not an adjourned or postponed meeting, however called and including any adjournment or postponement thereof) and in connection with any written consent of the stockholders of GigCapital5, the Sponsor shall:

a. when such meeting is held, appear at such meeting or otherwise cause the Sponsor Shares to be counted as present thereat for the purpose of establishing a quorum;

b. vote (or execute and return an action by written consent), or cause to be voted at such meeting (or validly execute and return and cause such consent to be granted with respect to), all of the Sponsor Shares (i) in favor of the approval and adoption of the BCA and approval of the Merger and all other transactions contemplated by the BCA and (ii) against any action, agreement or transaction or proposal that would result in a breach of any covenant, representation or warranty or any other obligation or agreement of GigCapital5 under the BCA or that would reasonably be expected to result in the failure of the Merger from being consummated and (iii) in favor of each of the proposals and any other matters necessary or reasonably requested by GigCapital5 for consummation of the Merger and the other transactions contemplated by the BCA; and

c. vote (or execute and return an action by written consent), or cause to be voted at such meeting (or validly execute and return and cause such consent to be granted with respect to), all of the Sponsor Shares against

(i) any Business Combination Proposal other than with the Company and (ii) any other action that would reasonably be expected to (x) materially impede, interfere with, delay, postpone or adversely affect the Merger or any of the other transactions contemplated by the BCA, or (y) result in a breach of any covenant, representation or warranty or other obligation or agreement of the Sponsor contained in this Agreement.

2. Transfer of Shares. Except as otherwise contemplated by the BCA or this Agreement, the Sponsor agrees that it shall not, directly or indirectly, (a) sell, assign, transfer (including by operation of law), create any lien or pledge, dispose of or otherwise encumber any of the Sponsor Shares or otherwise agree to do any of the foregoing, (b) deposit any Sponsor Shares into a voting trust or enter into a voting agreement or arrangement or grant any proxy or power of attorney with respect thereto that is inconsistent with this Agreement or (c) enter into any contract, option or other arrangement or undertaking requiring the direct acquisition or sale, assignment, transfer or other disposition of any Sponsor Shares. Without limiting the foregoing, and for the avoidance of doubt, the Sponsor agrees to comply, during the term of this Agreement, with the provisions of section 9 of that certain letter agreement, dated September 23, 2021, by and among GigCapital5, Sponsor, Wells Fargo Securities, LLC and William Blair & Company, L.L.C.

3. No Solicitation of Transactions. The Sponsor agrees not to directly or indirectly, through any officer, director, representative, agent or otherwise, (a) solicit, initiate or knowingly encourage (including by furnishing information) the submission of, or participate in any discussions or negotiations regarding, any transaction in violation of the BCA or (b) participate in any discussions or negotiations regarding, or furnish to any person or other entity or "group" within the meaning of Section 13(d) of the Exchange Act, any information with the intent to, or otherwise cooperate in any way with respect to, or knowingly assist, participate in, facilitate or encourage, any unsolicited proposal that constitutes, or may reasonably be expected to lead to, a Business Combination Proposal or other transaction in violation of the BCA. Sponsor shall, and shall cause its affiliates and Representatives to, immediately cease any and all existing discussions or negotiations with any person (other than with the Company, its stockholders and their respective affiliates and Representatives) conducted prior to the date hereof with respect to, or which is reasonably likely to give rise to or result in, a Business Combination Proposal. If the Sponsor receives any inquiry or proposal with respect to a Business Combination Proposal, then Sponsor shall promptly (and in no event later than twenty-four (24) hours after the Sponsor becomes aware of such inquiry or proposal) notify such person in writing that GigCapital5 is subject to an exclusivity agreement with respect to the Merger that prohibits Sponsor from considering such inquiry or proposal.

4. Representations and Warranties of the Sponsor. The Sponsor hereby represents and warrants to GigCapital5 and the Company as follows:

a. The Sponsor is the only record and a beneficial owner (within the meaning of Rule 13d-3 under the Exchange Act) of, and has good, valid and marketable title to, the Sponsor Shares, free and clear of Liens other than as created by this Agreement or Sponsor's organizational documents or the organizational documents of GigCapital5 (including, without limitation, for the purposes hereof, any agreement between or among stockholders of GigCapital5).

b. The Sponsor (i) has full voting power, full power of disposition and full power to issue instructions with respect to the matters set forth herein, in each case, with respect to the Sponsor Shares, (ii) has not entered into any voting agreement or voting trust with respect to any of the Sponsor Shares that is inconsistent with the Sponsor's obligations pursuant to this Agreement, (iii) has not granted a proxy or power of attorney with respect to any of the Sponsor Shares that is inconsistent with the Sponsor's obligations pursuant to this Agreement and (iv) has not entered into any agreement or undertaking that is otherwise inconsistent with, or would interfere with, or prohibit or prevent it from satisfying, its obligations pursuant to this Agreement.

c. The Sponsor (i) is a legal entity duly organized, validly existing and, to the extent such concept is applicable, in good standing under the Laws of the jurisdiction of its organization and (ii) has all requisite limited liability company or other power and authority and has taken all limited liability company or other action necessary in order to, execute, deliver and perform its obligations under this Agreement and to consummate the transactions contemplated hereby. This Agreement has been duly executed and delivered by the Sponsor and

constitutes a valid and binding agreement of the Sponsor enforceable against the Sponsor in accordance with its terms, subject to applicable bankruptcy, insolvency, fraudulent conveyance, reorganization, moratorium and similar Laws affecting creditors' rights generally and subject, as to enforceability, to general principles of equity.

d. Other than the filings, notices and reports pursuant to, in compliance with or required to be made under the Exchange Act, no filings, notices, reports, consents, registrations, approvals, permits, waivers, expirations of waiting periods or authorizations are required to be obtained by the Sponsor from, or to be given by the Sponsor to, or be made by the Sponsor with, any Governmental Authority in connection with the execution, delivery and performance by the Sponsor of this Agreement, the consummation of the transactions contemplated hereby or the Merger and the other transactions contemplated by the BCA.

e. The execution, delivery and performance of this Agreement by the Sponsor does not, and the consummation of the transactions contemplated hereby or the Merger and the other transactions contemplated by the BCA will not, constitute or result in (i) a breach or violation of, or a default under, the limited liability company agreement or similar governing documents of the Sponsor, (ii) with or without notice, lapse of time or both, a breach or violation of, a termination (or right of termination) of or a default under, the loss of any benefit under, the creation, modification or acceleration of any obligations under or the creation of a Lien on any of the properties, rights or assets of the Sponsor pursuant to any contract binding upon the Sponsor or, assuming (solely with respect to performance of this Agreement and the transactions contemplated hereby), compliance with the matters referred to in Section 1, under any applicable Law to which the Sponsor is subject or (iii) any change in the rights or obligations of any party under any contract legally binding upon the Sponsor, except, in the case of clause (ii) or (iii) directly above, for any such breach, violation, termination, default, creation, acceleration or change that would not, individually or in the aggregate, reasonably be expected to prevent or materially delay or impair the Sponsor's ability to perform its obligations hereunder or to consummate the transactions contemplated hereby, the consummation of the Merger or the other transactions contemplated by the BCA.

f. As of the date of this Agreement, there is no action, proceeding or investigation pending against the Sponsor or, to the knowledge of the Sponsor, threatened against the Sponsor that questions the beneficial or record ownership of the Sponsor Shares, the validity of this Agreement or the performance by the Sponsor of its obligations under this Agreement.

g. The Sponsor understands and acknowledges that each of GigCapital5 and the Company is entering into the BCA in reliance upon the Sponsor's execution and delivery of this Agreement and the representations, warranties, covenants and other agreements of the Sponsor contained herein

5. Further Assurances. From time to time, at either GigCapital5's or the Company's request and without further consideration, the Sponsor shall execute and deliver such additional documents and take all such further action as may be reasonably necessary or reasonably requested to effect the actions and consummate the transactions contemplated by this Agreement.

6. Changes in Capital Stock. In the event of a stock split, stock dividend or distribution, or any change in GigCapital5's capital stock by reason of any stock split, reverse stock split, recapitalization, combination, reclassification, exchange of shares or the like, equitable adjustment shall be made to the provisions of this Agreement as may be required so that the intended rights, privileges, duties and obligations hereunder shall be given full effect.

7. Amendment and Modification. This Agreement may not be amended, modified or supplemented in any manner, whether by course of conduct or otherwise, except by an instrument in writing signed by the Sponsor, GigCapital5 and the Company.

8. Waiver. No failure or delay by any party hereto exercising any right, power or privilege hereunder shall operate as a waiver thereof nor shall any single or partial exercise thereof preclude any other or further exercise thereof or the exercise of any other right, power or privilege. The rights and remedies of the parties hereto hereunder are cumulative and are not exclusive of any rights or remedies which they would otherwise have



hereunder. Any agreement on the part of a party hereto to any such waiver shall be valid only if set forth in a written instrument executed and delivered by such party.

9. Notices. All notices and other communications hereunder shall be in writing and shall be deemed given if delivered personally, by email (with confirmation of receipt) or sent by a nationally recognized overnight courier service to the parties hereto at the following addresses (or at such other address for a party as shall be specified by like notice made pursuant to this Section 9):

if to GigCapital5, to:

GigCapital5, Inc.  
1731 Embarcadero Road, Suite 200  
Palo Alto, CA 94303  
Attention: Dr. Raluca Dinu, President and Chief Executive Officer  
Dr. Avi S. Katz, Executive Chairman of the Board  
Email: \*\*\*, \*\*\*

with a copy to:

DLA Piper LLP (US)  
555 Mission Street  
Suite 2400  
San Francisco, CA 94105  
Attention: Jeffrey Selman; John Maselli  
Email: [jeffrey.selman@us.dlapiper.com](mailto:jeffrey.selman@us.dlapiper.com); [john.maselli@us.dlapiper.com](mailto:john.maselli@us.dlapiper.com)

if to the Sponsor, to:

GigAcquisitions5, LLC  
1731 Embarcadero Road, Suite 200  
Palo Alto, CA 94303  
Attention: Dr. Avi S. Katz, Manager  
Email: \*\*\*

if to the Company, to:

QT Imaging, Inc.  
3 Hamilton Landing, Suite 160  
Novato, California 94949  
Attention: Dr. John Klock, Chief Executive Officer  
Email: \*\*\*

with a copy to:

Seyfarth Shaw LLP  
975 F Street, NW  
Washington, DC 20004  
Attention: Andrew J. Sherman  
Email: [asherma@seyfarth.com](mailto:asherma@seyfarth.com)

10. Entire Agreement. This Agreement and the BCA constitute the entire agreement and supersede all prior agreements and understandings, both written and oral, among the parties hereto with respect to the subject matter hereof and thereof.

11. No Third-Party Beneficiaries. The Sponsor hereby agrees that its representations, warranties and covenants set forth herein are solely for the benefit of GigCapital5 and the Company in accordance with and subject to the terms of this Agreement, and this Agreement is not intended to, and does not, confer upon any person other than the parties hereto any rights or remedies hereunder, including, without limitation, the right to rely upon the representations and warranties set forth herein, and the parties hereto hereby further agree that this

Agreement may only be enforced against, and any action that may be based upon, arise out of or relate to this Agreement, or the negotiation, execution or performance of this Agreement may only be made against, the persons expressly named as parties hereto.

12. Governing Law; Venue; WAIVER OF JURY TRIAL.

a. This Agreement shall be governed by, interpreted under, and construed in accordance with the internal laws of the State of Delaware applicable to agreements made and to be performed within the State of Delaware, without giving effect to any choice-of-law provisions thereof that would compel the application of the substantive laws of any other jurisdiction.

b. All legal actions and proceedings arising out of or relating to this Agreement shall be heard and determined exclusively in any Delaware Chancery Court; *provided*, that if jurisdiction is not then available in the Delaware Chancery Court, then any such legal Action may be brought in any federal court located in the State of Delaware or any other Delaware state court. The parties hereto hereby (x) irrevocably submit to the exclusive jurisdiction of the aforesaid courts for themselves and with respect to their respective properties for the purpose of any Action arising out of or relating to this Agreement brought by any party hereto, and (y) agree not to commence any Action relating thereto except in the courts described above in Delaware, other than with respect to any appellate court thereof and other than Actions in any court of competent jurisdiction to enforce any judgment, decree or award rendered by any such court in Delaware as described herein. Each of the parties further agrees that notice as provided herein shall constitute sufficient service of process and the parties further waive any argument that such service is insufficient. Nothing in this Agreement will affect the right of any party to this Agreement to serve process in any other manner permitted by Law. Each of the parties irrevocably and unconditionally waives, and agrees not to assert, by way of motion or as a defense, counterclaim or otherwise, in any Action arising out of or relating to this Agreement or the transactions contemplated hereby, (i) any claim that it is not personally subject to the jurisdiction of the courts in Delaware as described herein for any reason, (ii) that it or its property is exempt or immune from jurisdiction of any such court or from any legal process commenced in such courts (whether through service of notice, attachment prior to judgment, attachment in aid of execution of judgment, execution of judgment or otherwise) and (iii) that (A) the Action in any such court is brought in an inconvenient forum, (B) the venue of such Action is improper or (C) this Agreement, or the subject matter hereof, may not be enforced in or by such courts.

c. EACH OF THE PARTIES HEREBY WAIVES TO THE FULLEST EXTENT PERMITTED BY APPLICABLE LAW ANY RIGHT IT MAY HAVE TO A TRIAL BY JURY WITH RESPECT TO ANY LITIGATION DIRECTLY OR INDIRECTLY ARISING OUT OF, UNDER OR IN CONNECTION WITH THIS AGREEMENT OR THE TRANSACTIONS CONTEMPLATED HEREBY. EACH OF THE PARTIES (I) CERTIFIES THAT NO REPRESENTATIVE, AGENT OR ATTORNEY OF ANY OTHER PARTY HAS REPRESENTED, EXPRESSLY OR OTHERWISE, THAT SUCH OTHER PARTY WOULD NOT, IN THE EVENT OF LITIGATION, SEEK TO ENFORCE THAT FOREGOING WAIVER AND (II) ACKNOWLEDGES THAT IT AND THE OTHERS HERETO HAVE BEEN INDUCED TO ENTER INTO THIS AGREEMENT BY, AMONG OTHER THINGS, THE MUTUAL WAIVERS AND CERTIFICATIONS IN THIS SECTION 12(C).

13. Assignment; Successors. Neither this Agreement nor any of the rights, interests or obligations hereunder shall be assigned by any of the parties hereto in whole or in part (whether by operation of Law or otherwise) without the prior written consent of the other party, and any such assignment without such consent shall be null and void. This Agreement shall be binding upon, inure to the benefit of and be enforceable by the parties hereto and their respective successors and permitted assigns.

14. Specific Performance. Each party acknowledges and agrees that the other parties hereto would be irreparably harmed and would not have any adequate remedy at law in the event that any of the provisions of this Agreement were not performed in accordance with their specific terms or were otherwise breached. Accordingly, each party agrees that the other parties hereto shall be entitled to an injunction or injunctions to prevent breaches of this Agreement and to enforce specifically the terms and provisions of this Agreement, this being in addition to any other remedy to which such parties are entitled at law or in equity.

15. Severability. In the event that any provision of this Agreement or the application thereof becomes or is declared by a court of competent jurisdiction to be illegal, void or unenforceable, the remainder of this Agreement will continue in full force and effect and the application of such provision to other persons or circumstances will be interpreted so as reasonably to effect the intent of the parties hereto.

16. Counterparts. This Agreement may be executed in one or more counterparts, all of which shall be considered one and the same agreement, it being understood that each party need not sign the same counterpart. This Agreement shall become effective when each party shall have received a counterpart hereof signed by all of the other parties. Signatures delivered electronically or by facsimile shall be deemed to be original signatures.

17. Termination. This Agreement shall terminate upon the earliest of (a) the Closing of the Merger, (b) the termination of the BCA in accordance with its terms, and (c) the time this Agreement is terminated upon the mutual written agreement of GigCapital5, the Company and the Sponsor.

*[Signature Pages Follow]*

IN WITNESS WHEREOF, the parties hereto have caused this Agreement to be executed (where applicable, by their respective officers or other authorized persons thereunto duly authorized) as of the date first written above.

**GIGCAPITAL5:**

**GIGCAPITAL5, INC.**

\_\_\_\_\_  
By: Dr. Raluca Dinu, President and Chief Executive Officer

**SPONSOR:**

**GIGACQUISITIONS5, LLC**

\_\_\_\_\_  
By: Dr. Avi S. Katz, Manager

*[Signature Page to Sponsor Support Agreement]*

IN WITNESS WHEREOF, the parties hereto have caused this Agreement to be executed (where applicable, by their respective officers or other authorized persons thereunto duly authorized) as of the date first written above.

**THE COMPANY:**

**QT IMAGING, INC.**

By: \_\_\_\_\_

Name: Dr. John Klock

Title: CEO and Chief Medical Officer

*[Signature Page to Sponsor Support Agreement]*

**EXHIBIT B**  
**Stockholder Support Agreement**

STOCKHOLDER SUPPORT AGREEMENT, dated as of December 8, 2022 (this “Agreement”), by and among GigCapital5, Inc., a Delaware corporation (“GigCapital5”), and certain of the stockholders of QT Imaging, Inc., a Delaware corporation (the “Company”), whose names appear on the signature pages of this Agreement (each, a “Stockholder” and, collectively, the “Stockholders”).

**RECITALS**

**WHEREAS**, GigCapital5, QTI Merger Sub, Inc., a Delaware corporation and wholly owned subsidiary of GigCapital5 (“Merger Sub”), and the Company have negotiated a Business Combination Agreement in the form attached hereto as Exhibit B (the “BCA”; terms used but not defined in this Agreement shall have the meanings ascribed to them in the BCA), which provides, among other things, that, upon the terms and subject to the conditions thereof, Merger Sub will merge with and into the Company (the “Merger”), with the Company surviving the Merger as a wholly owned subsidiary of GigCapital5; and

**WHEREAS**, as of the date hereof, each Stockholder owns of record the number of shares of Company Common Stock and Company Preferred Stock as set forth opposite such Stockholder’s name on Exhibit A hereto (all such shares of Company Common Stock and Company Preferred Stock and any shares of Company Common Stock and Company Preferred Stock of which ownership of record or the power to vote is hereafter acquired by the Stockholders prior to the termination of this Agreement being referred to herein as the “Shares”).

**AGREEMENT**

**NOW, THEREFORE**, in consideration of the foregoing and of the mutual covenants and agreements contained herein, and intending to be legally bound hereby, the parties hereto hereby agree as follows:

1. BCA Approved; Agreement to Vote. Each Stockholder, with respect to such Stockholder’s Shares, severally and not jointly, hereby agrees to vote, at any meeting of the Stockholders of the Company, and in any action by written consent of the Stockholders of the Company (which written consent shall be delivered promptly, and in any event within forty eight (48) hours, after the Company requests such delivery), all of the Shares held by such Stockholder at such time in favor of the approval and adoption of the BCA and approval of the Merger and all other transactions contemplated by the BCA, provided in all cases that no changes have been made in the BCA or in the Merger or related transactions or ancillary agreements under the BCA that are material to one or more of the Stockholders. Provided no changes are made in the BCA or in the Merger or related transactions or ancillary agreements under the BCA that are material to one or more of the Stockholders, each Stockholder, severally and not jointly, hereby agrees to vote at any meeting of the Stockholders of the Company, and to act by written consent of Company Stockholders, against any action, agreement, transaction or proposal that would cause a material breach of any covenant, representation, warranty or other obligation or agreement of the Company under the BCA or that would reasonably be expected to prevent the Merger from being consummated. Each Stockholder acknowledges receipt and review of a copy of the BCA.

2. Termination of Stockholder Rights. Subject to consummation of the Closing pursuant to the BCA, each Stockholder, severally and not jointly, hereby agrees that, if applicable to such Stockholder, any rights under Article VII (*Transfer of Shares and Admission of New Stockholders*) and Article VIII (*Tag Along Rights*) of the Company’s Bylaws, as amended, and any rights under any letter agreement providing for redemption rights, put rights, purchase rights or similar rights not generally available to Stockholders of the Company (the “Terminating Rights”) between such Stockholder and the Company, shall terminate (and such Stockholder, without any further action, shall automatically and irrevocably release and waive any claim such Stockholder may have thereunder)

immediately prior to the Closing under the BCA, and prior thereto such Stockholder shall not exercise such rights in any manner inconsistent with the BCA or otherwise reasonably likely to interfere with, delay, impede, frustrate or prevent the consummation of the Merger. For the avoidance of doubt, the Terminating Rights shall exclude any rights such Stockholder may have that relate to any commercial or employment agreements or arrangements between such Stockholder and the Company or any subsidiary of the Company, which shall survive in accordance with their terms.

3. Transfer of Shares. Each Stockholder, severally and not jointly, agrees that he, she or it shall not, directly or indirectly, (a) sell, assign, transfer (including by operation of law), create any lien or pledge, dispose of or otherwise encumber any of the Shares or otherwise agree to do any of the foregoing, except for a sale, assignment or transfer pursuant to the BCA or to another Stockholder of the Company that is a party to this Agreement and bound by the terms and obligations hereof, (b) deposit any Shares into a voting trust or enter into a voting agreement or arrangement or grant any proxy or power of attorney with respect thereto that is inconsistent with this Agreement or (c) enter into any contract, option or other arrangement or undertaking with respect to the direct acquisition or sale, assignment, transfer or other disposition of any Shares, except as set forth in the BCA or this Agreement; provided, that the foregoing shall not prohibit the transfer of the Shares to an affiliate of Stockholder, but only if such affiliate of such Stockholder shall execute this Agreement or a joinder agreeing to become a party to this Agreement.

4. No Solicitation of Transactions. Each of the Stockholders, severally and not jointly, agrees not to directly or indirectly, through any officer, director, representative, agent or otherwise, (a) solicit, initiate or knowingly encourage (including by furnishing information) the submission of, or participate in any discussions or negotiations regarding, any transaction in violation of the BCA or (b) participate in any discussions or negotiations regarding, or furnish to any person or other entity or "group" within the meaning of Section 13(d) of the Exchange Act, any information with the intent to, or otherwise cooperate in any way with respect to, or knowingly assist, participate in, facilitate or encourage, any unsolicited proposal that constitutes, or may reasonably be expected to lead to, an Alternative Transaction in violation of the BCA. Each Stockholder shall, and shall direct his, her or its representatives and agents to, immediately cease and cause to be terminated any discussions or negotiations with any parties that may be ongoing with respect to any Alternative Transaction (other than the transactions contemplated by the BCA) to the extent required by the BCA. If any Stockholder receives any inquiry or proposal with respect to an Alternative Transaction, then such Stockholder shall promptly (and in no event later than twenty-four (24) hours after such Stockholder becomes aware of such inquiry or proposal) notify such person in writing that the Company is subject to an exclusivity agreement with respect to the sale of the Company that prohibits such Stockholder from considering such inquiry or proposal.

5. Representations and Warranties. Each Stockholder, severally and not jointly, represents and warrants to GigCapital5 as follows:

(a) The execution, delivery and performance by such Stockholder of this Agreement and the consummation by such Stockholder of the transactions contemplated hereby do not and will not (i) conflict with or violate any statute, law, ordinance, regulation, rule, code, executive order, injunction, judgment, decree or other order applicable to such Stockholder, (ii) require any consent, approval or authorization of, declaration, filing or registration with, or notice to, any person or entity, (iii) result in the creation of any encumbrance on any Shares (other than under this Agreement, the BCA and the agreements contemplated by the BCA) or (iv) if such Stockholder is an entity, conflict with or result in a breach of or constitute a default under any provision of such Stockholder's governing documents.

(b) As of the date of this Agreement, such Stockholder owns exclusively of record and has good and valid title to the Shares set forth opposite the Stockholder's name on Exhibit A free and clear of any security interest, lien, claim, pledge, proxy, option, right of first refusal, agreement, voting restriction, limitation on disposition, charge, adverse claim of ownership or use or other encumbrance of any kind and has the sole power to vote and the right, power and authority to sell, transfer and deliver such Shares, other than pursuant and subject to: (i) this Agreement, (ii) applicable securities laws, and (iii) the Company's certificate of incorporation and bylaws. Such Stockholder is not the registered owner of any Shares other than those set forth on Exhibit A.

(c) Such Stockholder has the power, authority and capacity to execute, deliver and perform this Agreement and that this Agreement has been duly authorized, executed and delivered by such Stockholder. No person not a signatory to this Agreement (or such signatory's spouse for purposes of applicable community property laws) has a beneficial interest in or a right to acquire or vote any of the Shares (other than, if Stockholder is trust, the beneficiary(ies) thereof).

6. Termination. This Agreement and the obligations and liabilities of the Stockholders under this Agreement shall automatically terminate upon the earliest of (a) the Effective Time; (b) the termination of the BCA in accordance with its terms, (c) the effective date of a written agreement of the parties hereto terminating this Agreement and (d) any material breach by GigCapital5 of the BCA that is not fully cured within the time permitted by the BCA. Upon termination of this Agreement, neither party shall have any further obligations or liabilities under this Agreement. The representations and warranties contained in this Agreement and in any certificate or other writing delivered pursuant hereto shall not survive the Closing or the termination of this Agreement.

7. Miscellaneous.

(a) Except as otherwise provided herein, all costs and expenses incurred in connection with this Agreement and the transactions contemplated hereby shall be paid by the party incurring such costs and expenses, whether or not the transactions contemplated hereby are consummated.

(b) All notices, requests, claims, demands and other communications hereunder shall be in writing and shall be given (and shall be deemed to have been duly given upon receipt) by delivery in person, by e-mail or by registered or certified mail (postage prepaid, return receipt requested) to the respective parties at the following addresses or e-mail addresses (or at such other address or email address for a party as shall be specified in a notice given in accordance with this Section 7(b)):

If to GigCapital5, to:

GigCapital5, Inc.  
1731 Embarcadero Road, Suite 200  
Palo Alto, CA 94303  
Attention: Dr. Raluca Dinu, President and Chief Executive Officer  
Dr. Avi S. Katz, Executive Chairman of the Board  
Email: \*\*\*.\*\*\*

with a copy to:  
DLA Piper LLP (US)  
555 Mission Street  
Suite 2400  
San Francisco, CA 94105  
Attention: Jeffrey Selman; John Maselli  
Email: [jeffrey\\_selman@us.dlapiper.com](mailto:jeffrey_selman@us.dlapiper.com); [john.maselli@us.dlapiper.com](mailto:john.maselli@us.dlapiper.com)

If to a Stockholder, to the address or email address set forth for such Stockholder on the signature page hereof.

(c) If any term or other provision of this Agreement is invalid, illegal or incapable of being enforced by any rule of law, or public policy, all other conditions and provisions of this Agreement shall nevertheless remain in full force and effect so long as the economic or legal substance of the transactions contemplated hereby is not affected in any manner materially adverse to any party. Upon such determination that any term or other provision is invalid, illegal or incapable of being enforced, the parties hereto shall negotiate in good faith to modify this Agreement so as to effect the original intent of the parties as closely as possible in a mutually acceptable manner in order that the transactions contemplated hereby be consummated as originally contemplated to the fullest extent possible.

(d) This Agreement constitutes the entire agreement among the parties with respect to the subject matter hereof and supersedes all prior agreements and undertakings, both written and oral, among the parties, or



any of them, with respect to the subject matter hereof. This Agreement shall not be assigned (whether pursuant to a merger, by operation of law or otherwise), by any party without the prior express written consent of the other parties hereto except as permitted by Section 4.

(e) This Agreement shall be binding upon and inure solely to the benefit of each party hereto, and nothing in this Agreement, express or implied, is intended to or shall confer upon any other person any right, benefit or remedy of any nature whatsoever under or by reason of this Agreement. No Stockholder shall be liable for the breach by any other Stockholder of this Agreement.

(f) The parties hereto agree that irreparable damage would occur in the event any provision of this Agreement was not performed in accordance with the terms hereof and that the parties shall be entitled to specific performance of the terms hereof in addition to any other remedy at law or in equity.

(g) This Agreement shall be governed by, and construed in accordance with, the laws of the State of Delaware applicable to contracts executed in and to be performed in that State. All Actions arising out of or relating to this Agreement shall be heard and determined exclusively in any Delaware Chancery Court. The parties hereto hereby (i) submit to the exclusive jurisdiction of the Delaware Chancery Court for the purpose of any Action arising out of or relating to this Agreement brought by any party hereto, and (ii) irrevocably waive, and agree not to assert by way of motion, defense, or otherwise, in any such Action, any claim that he, she or it is not subject personally to the jurisdiction of the above-named courts, that his, her or its property is exempt or immune from attachment or execution, that the Action is brought in an inconvenient forum, that the venue of the Action is improper, or that this Agreement or the transactions contemplated hereunder may not be enforced in or by any of the above-named courts.

(h) This Agreement may be executed and delivered (including by facsimile or portable document format (pdf) transmission) in counterparts, and by the different parties hereto in separate counterparts, each of which when executed shall be deemed to be an original but all of which taken together shall constitute one and the same agreement.

(i) At the request of GigCapital5, in the case of any Stockholder, or at the request of any Stockholder, in the case of GigCapital5, and without further consideration, each party shall execute and deliver or cause to be executed and delivered such additional documents and instruments and take such further action as may be reasonably necessary to implement the provisions of this Agreement.

(j) Notwithstanding anything to the contrary herein, this Agreement may be amended by adding additional Stockholders of the Company ("Additional Stockholders") as parties hereto, upon such Additional Stockholders executing and delivering to GigCapital5, a Joinder to the Stockholder Support Agreement substantially in the form of Exhibit C hereto. Thereafter, each such Additional Stockholder shall, for all purposes, be a party hereto and all references to a "Stockholder" or the "Stockholders" herein shall thereafter also mean and refer to such Additional Stockholder, and such Additional Stockholder shall thereafter have the same rights, duties, liabilities and obligations as a Stockholder party hereto on the date hereof.

(k) This Agreement shall not be effective or binding upon any Stockholder until after such time as the BCA is executed and delivered by the Company, GigCapital5 and Merger Sub.

(l) EACH OF THE PARTIES HERETO HEREBY WAIVES TO THE FULLEST EXTENT PERMITTED BY APPLICABLE LAW ANY RIGHT HE, SHE OR IT MAY HAVE TO A TRIAL BY JURY WITH RESPECT TO ANY LITIGATION DIRECTLY OR INDIRECTLY ARISING OUT OF, UNDER OR IN CONNECTION WITH THIS AGREEMENT. EACH OF THE PARTIES HERETO (I) CERTIFIES THAT NO REPRESENTATIVE, AGENT OR ATTORNEY OF ANY OTHER PARTY HAS REPRESENTED, EXPRESSLY OR OTHERWISE, THAT SUCH OTHER PARTY WOULD NOT, IN THE EVENT OF LITIGATION, SEEK TO ENFORCE THAT FOREGOING WAIVER AND (II) ACKNOWLEDGES THAT HE, SHE OR IT AND THE OTHER PARTIES HERETO HAVE BEEN INDUCED TO ENTER INTO THIS AGREEMENT AND THE TRANSACTIONS CONTEMPLATED HEREBY, AS APPLICABLE, BY, AMONG OTHER THINGS, THE MUTUAL WAIVERS AND CERTIFICATIONS IN THIS SECTION 6(K).

*[Signature Pages Follow]*

IN WITNESS WHEREOF, the parties have executed this Agreement as of the date first written above.

**GIGCAPITAL5, INC.**

By: \_\_\_\_\_  
Name: Dr. Raluca Dinu  
Title: President and Chief Executive Officer

*Signature page to Stockholder Support Agreement*

IN WITNESS WHEREOF, the parties have executed this Agreement as of the date first written above.

**[STOCKHOLDER NAME]**

By: \_\_\_\_\_  
Name: \_\_\_\_\_  
Title: \_\_\_\_\_  
Address: \_\_\_\_\_  
\_\_\_\_\_  
\_\_\_\_\_  
Email: \_\_\_\_\_

**EXHIBIT A**

**Stockholders of Record – Number of Shares**

<b><u>Stockholder of Record</u></b>	<b><u>Number of Shares</u></b>
John C. Klock, Jr. and Cynthia L. Klock Trust Dated 7/27/07	***
Biotex Pharma Investments, LLC	***
Biotex Pharma Investments II, LLC	***
Kenneth G. Hunderford Trust	***
B.D. Winston Family, Ltd.	***
Richard J. and Barbara Stanley	***
CVUS Ventures, LP	***
Jachirijo Holdings LLC	***
Mikel Ann Price	***
Nasser Pirshafiey	***
303 Development Corp.	***
Margaret Donigan	***

---

**EXHIBIT B**

**Business Combination Agreement**

See Attached

*Exhibit B to Stockholder Support Agreement*

**EXHIBIT C**

**JOINDER TO STOCKHOLDER SUPPORT AGREEMENT**

This JOINDER TO STOCKHOLDER SUPPORT AGREEMENT (this “Joinder”) is made and entered into as of [●], by and among each of the stockholders of QT Imaging, Inc., a Delaware corporation (the “Company”), whose names appear on the signature pages of this Joinder (each, a “Stockholder” and, collectively, the “Stockholders”), and GigCapital5, Inc., a Delaware corporation (“GigCapital5”).

**RECITALS**

A. GigCapital5 and certain stockholders of the Company have entered into a Stockholder Support Agreement dated December 8, 2022 (as amended, modified, supplemented, extended or restated from time to time, the “Agreement”) in regard to the support of the Merger and the other transactions contemplated by the BCA. Capitalized terms used herein but not otherwise defined shall have the meanings set forth in the Agreement.

B. Pursuant to the Agreement, certain stockholders of the Company have agreed, among other things, to (i) vote in favor of the approval and adoption of the BCA and approval of the Merger and all other transactions contemplated by the BCA, and (ii) terminate the Terminating Rights effective immediately prior to the Closing under the BCA.

C. In order to induce GigCapital5 to consummate the Merger and other transactions contemplated by the BCA, [the] [each] Additional Stockholder is willing to become a party to the Agreement and be bound by all terms and conditions thereof.

NOW, THEREFORE, in consideration of the mutual covenants contained herein and other good and valuable consideration, the receipt and sufficiency of which are hereby acknowledged, the parties to this Joinder hereby agree as follows:

1. Agreement to be bound. [Each] [The] Additional Stockholder hereby: (a) acknowledges that he, she or it has received and reviewed a complete copy of the Agreement and understands its terms, (b) has had sufficient opportunity to review and to ask questions relating thereto and obtain the advice of his, her or its tax advisors, legal counsel and accountants and other professional advisors prior to executing this Agreement, and (c) agrees that upon execution of this Joinder, it shall become a “Stockholder” under the Agreement and shall be fully bound by, and subject to, all of the covenants, duties, obligations terms and conditions of the Agreement as though an original party thereto.

2. Governing Law. This Joinder and all acts and transactions pursuant hereto and the rights and obligations of the parties hereto shall be governed, construed and interpreted in accordance with the laws of the State of Delaware applicable to contracts executed in and to be performed in that State.

3. Counterparts. This Joinder may be executed in two or more counterparts, each of which shall be an original and all of which together shall constitute one instrument.

[REMAINDER OF THIS PAGE INTENTIONALLY LEFT BLANK]

*Exhibit C to Stockholder Support Agreement*

IN WITNESS WHEREOF, the parties hereto have executed this Joinder to Stockholder Support Agreement as of the date first above written.

**[STOCKHOLDER NAME]**

By: \_\_\_\_\_

Name:

Title:

Address: \_\_\_\_\_

\_\_\_\_\_

\_\_\_\_\_

Email: \_\_\_\_\_

Securities beneficially owned on the date hereof:

\_\_\_\_\_ shares of Common Stock

IN WITNESS WHEREOF, the parties have executed this Joinder to Stockholder Support Agreement as of the date first written above.

**GIGCAPITAL5, INC.**

By: \_\_\_\_\_

Name: Dr. Raluca Dinu

Title: President and Chief Executive Officer

*Exhibit C to Stockholder Support Agreement*



**STOCKHOLDER SUPPORT AGREEMENT  
SPOUSAL CONSENT**

I \_\_\_\_\_, spouse of \_\_\_\_\_, have read and approve the foregoing Stockholder Support Agreement (the "**Agreement**"). In consideration of the terms and conditions as set forth in the Agreement, I hereby appoint my spouse as my attorney-in-fact with respect to the exercise of any rights and obligations under the Agreement, and agree to be bound by the provisions of the Agreement insofar as I may have any rights or obligations in the Agreement under the community property laws or similar laws relating to marital or community property in effect in the state of our residence as of the date of the Agreement.

Date \_\_\_\_\_

Signature of Spouse \_\_\_\_\_

Printed Name of Spouse \_\_\_\_\_

## EXHIBIT C

### REGISTRATION RIGHTS AGREEMENT

This Registration Rights Agreement (this “**Agreement**”) is made and entered into as of [●], 2023, by and among GigCapital5, Inc., a Delaware corporation (the “**Company**”), and each of the undersigned parties listed under “Holder” on the signature page hereto (each such party, a “**Holder**” and collectively the “**Holders**”). Any capitalized term used but not defined herein will have the meaning ascribed to such term in the Business Combination Agreement (as defined below).

#### RECITALS

WHEREAS, on December 8, 2022, the Company, QTI Merger Sub, Inc., a Delaware corporation and a wholly-owned direct subsidiary of the Company (“**Merger Sub**”), and QT Imaging, Inc., a Delaware corporation (“**QTI**”), entered into that certain Business Combination Agreement (the “**Business Combination Agreement**”), pursuant to which Merger Sub will merge with and into QTI (the “**Merger**”), with QTI surviving the Merger as a wholly-owned subsidiary of the Company;

WHEREAS, pursuant to the Business Combination Agreement, the Company is issuing shares of the Company’s common stock, par value \$0.0001 per share (the “**Common Stock**”), to the Holders designated on Schedule A hereto and may in the future issue additional shares of Common Stock to such Holders (the “**Earnout Shares**”); and

WHEREAS, the Company desires to set forth certain matters regarding the ownership of the Registrable Securities (as defined below) by the Holders.

NOW, THEREFORE, in consideration of the mutual covenants and agreements set forth herein, and for other good and valuable consideration, the receipt and sufficiency of which are hereby acknowledged, the parties hereto agree as follows:

#### ARTICLE I DEFINITIONS

**Section 1.1 Definitions.** For purposes of this Agreement, the following terms and variations thereof have the meanings set forth below:

“**Action**” has the meaning set forth in Section 6.7.

“**Agreement**” shall have the meaning given in the Preamble.

“**Adverse Disclosure**” means any public disclosure of material non-public information, which disclosure, in the good faith judgment of the Chief Executive Officer or Chief Financial Officer of the Company, after consultation with outside counsel to the Company, (i) would be required to be made in any Registration Statement or Prospectus in order for the applicable Registration Statement or Prospectus not to contain any untrue statement of a material fact or omit to state a material fact necessary to make the statements contained therein (in the case of any prospectus and any preliminary prospectus, in the light of the circumstances under which they were made) not misleading, (ii) would not be required to be made at such time if the Registration Statement were not being filed, and (iii) the Company has a bona fide business purpose for not making such information public.

“**Board**” shall mean the Board of Directors of the Company.

“**Business Combination Agreement**” has the meaning set forth in the Recitals.

“**Business Day**” means a day other than Saturday, Sunday or other day on which commercial banks in New York, New York are authorized or required by law to close.

“**Commission**” means the Securities and Exchange Commission, or any other federal agency then administering the Securities Act or the Exchange Act.

“**Common Stock**” shall have the meaning given in the Recitals. “**Company**” shall have the meaning given in the Preamble. “**Demand Registration**” has the meaning set forth in [Section 2.1.1](#).

“**Demanding Holder**” has the meaning set forth in [Section 2.1.1](#).

“**Demand Registration**” has the meaning set forth in [Section 2.1.1](#).

“**Earnout Shares**” has the meaning set forth in the Recitals.

“**Exchange Act**” means the Securities Exchange Act of 1934, as amended, and the rules and regulations of the Commission promulgated thereunder, all as the same shall be in effect at the time.

“**Form S-3**” has the meaning set forth in [Section 2.3](#).

“**Holdings**” shall have the meaning given in the Preamble.

“**Maximum Number of Securities**” shall have the meaning given in [Section 2.1.4](#).

“**Misstatement**” means an untrue statement of a material fact or an omission to state a material fact required to be stated in a Registration Statement or Prospectus, or necessary to make the statements in a Registration Statement or Prospectus in the light of the circumstances under which they were made not misleading.

“**Notices**” has the meaning set forth in [Section 6.2](#).

“**Person**” means any individual, corporation, limited liability company, partnership, joint venture, association, trust, unincorporated organization or any other entity, including a governmental authority.

“**Piggyback Registration**” has the meaning set forth in [Section 2.2.1](#).

“**Prospectus**” means the prospectus included in any Registration Statement, as supplemented by any and all prospectus supplements and as amended by any and all post-effective amendments and including all material incorporated by reference in such prospectus.

“**Registrable Securities**” means (i) any equity securities (including the shares of Common Stock issued or issuable upon the exercise or conversion of any such equity security) of the Company held by a Holder immediately following consummation of the Merger and (ii) all of the Earnout Shares. Registrable Securities include any warrants, shares of capital stock or other securities of the Company issued as a dividend or other distribution with respect to or in exchange for or in replacement of any of the securities described in the foregoing clauses (i)—(ii). As to any particular Registrable Security, such security shall cease to be a Registrable Security when: (a) a Registration Statement with respect to the sale of such security shall have become effective under the Securities Act and such security shall have been sold, transferred, disposed of or exchanged in accordance with such Registration Statement; (b) such security shall have been otherwise transferred, a new certificate for such security not bearing a legend restricting further transfer shall have been delivered by the

Company and subsequent public distribution of such security shall not require registration under the Securities Act; (c) such security shall have ceased to be outstanding; or (d) such security has been sold pursuant to Rule 144.

“**Registration**” means a registration effected by preparing and filing a registration statement or similar document in compliance with the requirements of the Securities Act, and the applicable rules and regulations promulgated thereunder, and such registration statement becoming effective.

“**Registration Expenses**” means the out-of-pocket expenses of a Registration, including, without limitation, the following:

(A) all registration and filing fees (including fees with respect to filings required to be made with the Financial Industry Regulatory Authority and any securities exchange on which the Common Stock is then listed);

(B) fees and expenses of compliance with securities or blue sky laws (including reasonable fees and disbursements of counsel for the Underwriters in connection with blue sky qualifications of Registrable Securities);

(C) printing, messenger, telephone and delivery expenses;

(D) reasonable fees and disbursements of counsel for the Company;

(E) reasonable fees and disbursements of all independent registered public accountants of the Company incurred specifically in connection with such Registration; and

(F) reasonable fees and expenses of one (1) legal counsel selected by the majority-in-interest of the Demanding Holders initiating a Demand Registration to be registered for offer and sale in the applicable Registration.

“**Registration Statement**” means a registration statement filed by the Company with the Commission in compliance with the Securities Act and the rules and regulations promulgated thereunder for a public offering and sale of securities (other than a registration statement on Form S-4 or Form S-8, or their successors, or any registration statement covering only securities proposed to be issued in exchange for securities or assets of another entity).

“**Requesting Holder**” has the meaning set forth in [Section 2.1.1](#).

“**Rule 144**” means Rule 144 promulgated under the Securities Act.

“**SEC**” means the United States Securities and Exchange Commission or any successor thereto.

“**Securities Act**” means the Securities Act of 1933, as amended, and the rules and regulations of the Commission promulgated thereunder, all as the same shall be in effect at the time.

“**Transfer**” means to, directly or indirectly, sell, transfer, assign, pledge, encumber, hypothecate or similarly dispose of, either voluntarily or involuntarily, or to enter into any contract, option or other arrangement or understanding with respect to the sale, transfer, assignment, pledge, encumbrance, hypothecation or similar disposition of, any interest owned by a person or any interest (including a beneficial interest) in, or the ownership, control or possession of, any interest owned by a person.

“**Underwriter**” means a securities dealer who purchases any Registrable Securities as principal in an underwritten offering and not as part of such dealer’s market-making activities.

“**Underwritten Registration**” or “**Underwritten Offering**” means a Registration in which securities of the Company are sold to an Underwriter in a firm commitment underwriting for distribution to the public.

**ARTICLE II  
REGISTRATION**

**Section 2.1 Demand Registration**

2.1.1 Request for Registration. Subject to the provisions of Section 2.1.4 and Section 2.4 hereof, at any time and from time to time on or after the Closing Date, the Holders holding at least a majority in interest of the then-outstanding number of Registrable Securities held by all the Holders (such Holders, the “**Demanding Holders**”), may make a written demand for Registration under the Securities Act of all or part of their Registrable Securities, which written demand shall describe the amount and type of securities to be included in such Registration and the intended method(s) of distribution thereof (such written demand a “**Demand Registration**”). The Company shall, within ten (10) days of the Company’s receipt of the Demand Registration, notify, in writing, all other Holders of Registrable Securities of such demand, and each Holder of Registrable Securities who thereafter wishes to include all or a portion of such Holder’s Registrable Securities in the Demand Registration (each such Holder that includes all or a portion of such Holder’s Registrable Securities in such Registration, a “**Requesting Holder**”) shall so notify the Company, in writing, within five (5) days after the receipt by the Holder of the notice from the Company. Upon receipt by the Company of any such written notification from a Requesting Holder(s) to the Company, such Requesting Holder(s) shall be entitled to have their Registrable Securities included in a Registration pursuant to a Demand Registration and the Company shall effect, as soon thereafter as practicable, but not more than forty five (45) days immediately after the Company’s receipt of the Demand Registration, the Registration of all Registrable Securities requested by the Demanding Holders and Requesting Holders pursuant to such Demand Registration. Under no circumstances shall the Company be obligated to effect more than an aggregate of three (3) Registrations pursuant to a Demand Registration under this Section 2.1.1 initiated by Holders; provided, however, that an Underwritten Offering pursuant to a Demand Registration shall not be counted for such purposes unless a Registration Statement that may be available at such time has become effective and all of the Registrable Securities requested by the Demanding Holders to be registered on behalf of the Demanding Holders in such Registration Statement have been sold, in accordance with Section 3.1 of this Agreement.

2.1.2 Effective Registration. Notwithstanding the provisions of Section 2.1.1 above or any other part of this Agreement, a Registration pursuant to a Demand Registration shall not count as a Registration unless and until (i) the Registration Statement filed with the Commission with respect to such Demand Registration has been declared effective by the Commission and (ii) the Company has complied with all of its obligations under this Agreement with respect thereto; provided, that if, after such Registration Statement has been declared effective, the offering of Registrable Securities pursuant to a Demand Registration is interfered with by any stop order or injunction of the Commission or any other governmental agency or court, the Registration Statement with respect to such Demand Registration will be deemed not to have been declared effective, unless and until, (i) such stop order or injunction is removed, rescinded or otherwise terminated, and (ii) a majority-in-interest of the Demanding Holders initiating such Demand Registration thereafter affirmatively elect to continue with such Registration and accordingly notify the Company in writing of such election, which notice shall be received by the Company not later than five (5) days after the removal of any such stop order or injunction; provided, further, that the Company shall not be obligated to file a second Registration Statement until a Registration Statement that has been previously filed pursuant to a Demand Registration becomes effective or is terminated.

2.1.3 Underwritten Offering. Subject to the provisions of Section 2.1.4 and Section 2.4 hereof, if a majority-in-interest of the Demanding Holders so advise the Company as part of their Demand Registration that the offering of Registrable Securities pursuant thereto shall be in the form of an Underwritten Offering, then the right of such Demanding Holder or Requesting Holder (if any) to include its Registrable Securities in such Registration shall be conditioned upon such Holder’s participation in such Underwritten Offering and the inclusion of such Holder’s Registrable Securities in such Underwritten Offering to the extent provided herein. All such Holders proposing to distribute their Registrable Securities through an Underwritten Offering under this Section 2.1.3 shall enter into an underwriting agreement in customary form with the Underwriter(s) selected for such Underwritten Offering by a majority-in-interest of the Demanding Holders initiating the Demand Registration.

2.1.4 Reduction of Underwritten Offering. If the managing Underwriter(s) for a Demand Registration that is to be an Underwritten Offering, in good faith, advises the Company, the Demanding Holders and the Requesting Holders in writing that the dollar amount or number of Registrable Securities which the Demanding Holders and the Requesting Holders (if any) desire to sell, taken together with all other shares of Common Stock or other equity securities which the Company desires to sell and the shares of Common Stock, if any, as to which a Registration has been requested pursuant to separate written contractual piggyback registration rights held by other stockholders of the Company who desire to sell, exceeds the maximum dollar amount or maximum number of equity securities that can be sold in the Underwritten Offering without adversely affecting the proposed offering price, the timing, the distribution method, or the probability of success of such Underwritten Offering (such maximum dollar amount or maximum number of securities, as applicable, the “**Maximum Number of Securities**”), then the Company shall include in such Underwritten Offering, as follows: (i) first, the Registrable Securities of the Demanding Holders and the Requesting Holders (if any) (pro rata based on the respective number of Registrable Securities that each Demanding Holder and Requesting Holder (if any) has requested be included in such Underwritten Registration and the aggregate number of Registrable Securities that the Demanding Holders and Requesting Holders have requested be included in such Underwritten Registration (such proportion is referred to herein as “**Pro Rata**”, provided, however, that such Pro Rata proportion shall not include any unvested Earnout Shares)) that can be sold without exceeding the Maximum Number of Securities; (ii) second, to the extent that the Maximum Number of Securities has not been reached under the foregoing clause (i), the Registrable Securities of Holders (Pro Rata, based on the respective number of Registrable Securities that each Holder has so requested exercising their rights to register their Registrable Securities pursuant to Section 2.2.1 hereof), that can be sold without exceeding the Maximum Number of Securities; (iii) third, to the extent that the Maximum Number of Securities has not been reached under the foregoing clauses (i) and (ii), the Common Stock or other equity securities that the Company desires to sell, which can be sold without exceeding the Maximum Number of Securities; and (iv) fourth, to the extent that the Maximum Number of Securities has not been reached under the foregoing clauses (i), (ii) and (iii), the Common Stock or other equity securities of other persons or entities that the Company is obligated to register in a Registration pursuant to separate written contractual arrangements with such persons and that can be sold without exceeding the Maximum Number of Securities.

2.1.5 Demand Registration Withdrawal. Any Demanding Holder shall have the right to withdraw from a Registration pursuant to such Demand Registration for any or no reason whatsoever upon written notification to the Company and the Underwriter(s) (if any) of their intention to withdraw from such Registration prior to the effectiveness of the Registration Statement filed with the Commission with respect to the Registration of their Registrable Securities pursuant to such Demand Registration. Notwithstanding anything to the contrary in this Agreement, if with respect to a Demand Registration, a majority-in-interest of the Demanding Holders initiating a Demand Registration so withdraw from a Registration pursuant to such Demand Registration, such Registration shall not count as a Demand Registration provided for in Section 2.1.1 and the Company shall be responsible for the Registration Expenses incurred in connection with a Registration pursuant to a Demand Registration prior to its withdrawal under this Section 2.1.5.

## **Section 2.2 Piggyback Registration.**

2.2.1 Piggyback Rights. If, at any time on or after the Closing Date, the Company proposes to file a Registration Statement under the Securities Act with respect to an offering of equity securities, or securities or other obligations exercisable or exchangeable for, or convertible into, equity securities, for its own account or for the account of stockholders of the Company (or by the Company and by stockholders of the Company including, without limitation, pursuant to Section 2.1), other than a Registration Statement (i) filed in connection with any employee stock option or other benefit plan, (ii) for an exchange offer or offering of securities solely to the Company’s existing stockholders, (iii) for an offering of debt that is convertible into equity securities of the Company or (iv) for a dividend reinvestment plan, then the Company shall (x) give written notice of such proposed filing to all of the Holders of Registrable Securities as soon as practicable but in no event less than ten (10) days before the anticipated filing date, which notice shall describe the amount and type of securities to be included in such offering, the intended method(s) of distribution, and the name of the proposed managing Underwriter or Underwriters, if any, of the offering, and (y) offer to all of the Holders of Registrable Securities in

such notice the opportunity to register the sale of such number of shares of Registrable Securities as such Holders may request in writing within five (5) days following receipt of such notice (a “**Piggyback Registration**”). The Company shall, in good faith, cause such Registrable Securities to be included in such Registration and shall use its best efforts to cause the managing Underwriter(s) of a proposed Underwritten Offering to permit the Registrable Securities requested to be included in such Piggyback Registration on the same terms and conditions as any similar securities of the Company and to permit the sale or other disposition of such Registrable Securities in accordance with the intended method(s) of distribution thereof. All holders of Registrable Securities proposing to distribute their Registrable Securities through a Piggyback Registration that involves an Underwriter(s) shall enter into an underwriting agreement in customary form with the Underwriter(s) selected for such Piggyback Registration.

**2.2.2 Reduction of Piggyback Registration.** If the managing Underwriter(s) for a Piggyback Registration that is to be an Underwritten Offering, in good faith, advises the Company and the Holders of Registrable Securities participating in the Piggyback Registration in writing that the dollar amount or number of securities which the Company desires to sell, taken together with (i) the Common Stock or other equity securities, if any, as to which Registration has been demanded pursuant to separate written contractual arrangements with persons or entities other than the Holders of Registrable Securities hereunder, (ii) the Registrable Securities as to which Registration has been requested under this [Section 2.2](#), and (iii) the Common Stock or other equity securities, if any, as to which Registration has been requested pursuant to separate written contractual piggyback registration rights of other stockholders of the Company, exceeds the Maximum Number of Securities, then:

(i) If the Registration is undertaken for the Company’s account, the Company shall include in any such Registration (A) first, the Common Stock or other equity securities that the Company desires to sell, which can be sold without exceeding the Maximum Number of Securities; (B) second, to the extent that the Maximum Number of Securities has not been reached under the foregoing clause (A), the Common Stock, if any, as to which Registration has been requested pursuant to written contractual piggyback registration rights of other stockholders of the Company that pre-dates this Agreement, which can be sold without exceeding the Maximum Number of Securities; (C) third, to the extent that the Maximum Number of Securities has not been reached under the foregoing clauses (A) and (B), the Registrable Securities of Holders exercising their rights to register their Registrable Securities pursuant to [Section 2.2.1](#) hereof, Pro Rata, which can be sold without exceeding the Maximum Number of Securities; and (D) fourth, to the extent that the Maximum Number of Securities has not been reached under the foregoing clauses (A), (B) and (C), the Common Stock, if any, as to which Registration has been requested pursuant to written contractual piggyback registration rights of other stockholders of the Company not otherwise covered above, which can be sold without exceeding the Maximum Number of Securities; and

(ii) If the Registration is pursuant to a request by persons or entities other than the Holders of Registrable Securities, then the Company shall include in any such Registration (A) first, the Common Stock or other equity securities, if any, of such requesting persons or entities, other than the Holders of Registrable Securities, which can be sold without exceeding the Maximum Number of Securities; (B) second, to the extent that the Maximum Number of Securities has not been reached under the foregoing clause (A), the Registrable Securities of Holders exercising their rights to register their Registrable Securities pursuant to [Section 2.2.1](#), Pro Rata based on the number of Registrable Securities that each Holder has requested be included in such Underwritten Registration and the aggregate number of Registrable Securities that the Holders have requested to be included in such Underwritten Registration, which can be sold without exceeding the Maximum Number of Securities; (C) third, to the extent that the Maximum Number of Securities has not been reached under the foregoing clauses (A) and (B), the Common Stock or other equity securities that the Company desires to sell, which can be sold without exceeding the Maximum Number of Securities; and (D) fourth, to the extent that the Maximum Number of Securities has not been reached under the foregoing clauses (A), (B) and (C), the Common Stock or other equity securities for the account of other persons or entities that the Company is obligated to register pursuant to separate written contractual arrangements with such persons or entities, which can be sold without exceeding the Maximum Number of Securities.

**2.2.3 Piggyback Registration Withdrawal.** Any Holder of Registrable Securities shall have the right to withdraw from a Piggyback Registration for any or no reason whatsoever upon written notification to the Company and the Underwriter(s) of his, her or its intention to withdraw from such Piggyback Registration prior to the effectiveness of the Registration Statement filed with the Commission with respect to such Piggyback Registration. The Company (whether on its own good faith determination or as the result of a request for withdrawal by persons pursuant to separate written contractual obligations) may withdraw a Registration Statement filed with the Commission in connection with a Piggyback Registration at any time prior to the effectiveness of such Registration Statement. Notwithstanding anything to the contrary in this Agreement, the Company shall be responsible for the Registration Expenses incurred in connection with the Piggyback Registration prior to its withdrawal under this Section 2.2.3.

**2.2.4 Unlimited Piggyback Registration Rights.** For purposes of clarity, any Registration effected pursuant to Section 2.2 hereof shall not be counted as a Registration pursuant to a Demand Registration effected under Section 2.1 hereof.

**Section 2.3 Registration on Form S-3.** The Holders of Registrable Securities may at any time, and from time to time, request in writing that the Company, pursuant to Rule 415 under the Securities Act (or any successor rule promulgated thereafter by the Commission), register the resale of any or all of their Registrable Securities on Form S-3 or any similar short-form registration statement that may be available at such time ("**Form S-3**"); provided, that the Company shall not be obligated to effect such request through an Underwritten Offering. Within five (5) days of the Company's receipt of a written request from a Holder or Holders of Registrable Securities for a Registration on Form S-3, the Company shall promptly give written notice of the proposed Registration on Form S-3 to all other Holders of Registrable Securities, and each Holder of Registrable Securities who thereafter wishes to include all or a portion of such Holder's Registrable Securities in such Registration on Form S-3 shall so notify the Company, in writing, within ten (10) days after the receipt by the Holder of the notice from the Company. As soon as practicable thereafter, but not more than twelve (12) days after the Company's initial receipt of such written request for a Registration on Form S-3, the Company shall register all or such portion of such Holder's Registrable Securities as are specified in such written request, together with all or such portion of Registrable Securities of any other Holder or Holders joining in such request as are specified in the written notification given by such Holder or Holders; provided, that the Company shall not be obligated to effect any such Registration pursuant to this Section 2.3 if (i) a Form S-3 is not available for such offering; or (ii) the Holders of Registrable Securities, together with the Holders of any other equity securities of the Company entitled to inclusion in such Registration, propose to sell the Registrable Securities and such other equity securities (if any) at any aggregate price to the public of less than \$5,000,000. Registrations effected pursuant to this Section 2.3 shall not be counted as Demand Registrations effected pursuant to Section 2.1.

**Section 2.4 Restrictions on Registration Rights.** If (A) during the period starting with the date sixty (60) days prior to the Company's good faith estimate of the date of the filing of, and ending on a date one hundred and twenty (120) days after the effective date of, a Company initiated Registration and provided that the Company has delivered written notice to the Holders prior to receipt of a Demand Registration pursuant to Section 2.1.1 and it continues to actively employ, in good faith, all reasonable efforts to cause the applicable Registration Statement to become effective; (B) the Holders have requested an Underwritten Registration and the Company and the Holders are unable to obtain the commitment of underwriters to firmly underwrite the offer; or (C) in the good faith judgment of the Board such Registration would be seriously detrimental to the Company and the Board concludes as a result that it is essential to defer the filing of such Registration Statement at such time, then in each case the Company shall furnish to such Holders a certificate signed by the Chairman of the Board stating that in the good faith judgment of the Board it would be seriously detrimental to the Company for such Registration Statement to be filed in the near future and that it is therefore essential to defer the filing of such Registration Statement. In such event, the Company shall have the right to defer such filing for a period of not more than thirty (30) days; provided, that the Company may not defer its obligation in this manner more than once in any 12-month period.



**ARTICLE III  
REGISTRATION PROCEDURES**

**Section 3.1 General Procedures.** If at any time on or after the Closing Date the Company is required to effect the registration of any Registrable Securities pursuant to Section 2, the Company shall use its best efforts to effect the Registration to permit the sale of such Registrable Securities in accordance with the intended plan of distribution thereof, and pursuant thereto the Company shall, as expeditiously as practicable and in connection with any such request:

3.1.1 prepare and file with the Commission as soon as practicable a Registration Statement with respect to such Registrable Securities and use its reasonable best efforts to cause such Registration Statement to become effective and remain effective until all Registrable Securities covered by such Registration Statement have been sold;

3.1.2 prepare and file with the Commission such amendments and post-effective amendments to the Registration Statement, and such supplements to the Prospectus, as may be reasonably requested by the Holders or any Underwriter of Registrable Securities or as may be required by the rules, regulations or instructions applicable to the registration form used by the Company or by the Securities Act or rules and regulations thereunder to keep the Registration Statement effective until all Registrable Securities covered by such Registration Statement are sold in accordance with the intended plan of distribution set forth in such Registration Statement or supplement to the Prospectus;

3.1.3 prior to filing a Registration Statement or Prospectus, or any amendment or supplement thereto, furnish without charge to the Underwriters, if any, and the Holders of Registrable Securities included in such Registration, and such Holders' legal counsel, copies of such Registration Statement as proposed to be filed, each amendment and supplement to such Registration Statement (in each case including all exhibits thereto and documents incorporated by reference therein), the Prospectus included in such Registration Statement (including each preliminary Prospectus), and such other documents as the Underwriters and the Holders of Registrable Securities included in such Registration or the legal counsel for any such Holders may request in order to facilitate the disposition of the Registrable Securities owned by such Holders;

3.1.4 prior to any public offering of Registrable Securities, use its best efforts to (i) register or qualify the Registrable Securities covered by the Registration Statement under such securities or "blue sky" laws of such jurisdictions in the United States as the Holders of Registrable Securities included in such Registration Statement (in light of their intended plan of distribution) may request and (ii) take such action necessary to cause such Registrable Securities covered by the Registration Statement to be registered with or approved by such other governmental authorities as may be necessary by virtue of the business and operations of the Company and do any and all other acts and things that may be necessary or advisable to enable the Holders of Registrable Securities included in such Registration Statement to consummate the disposition of such Registrable Securities in such jurisdictions; provided, that the Company shall not be required to qualify generally to do business in any jurisdiction where it would not otherwise be required to qualify or take any action to which it would be subject to general service of process or taxation in any such jurisdiction where it is not then otherwise so subject;

3.1.5 cause all such Registrable Securities to be listed on each securities exchange or automated quotation system on which similar securities issued by the Company are then listed;

3.1.6 provide a transfer agent or warrant agent, as applicable, and registrar for all such Registrable Securities no later than the effective date of such Registration Statement;

3.1.7 advise each seller of such Registrable Securities, promptly after it shall receive notice or obtain knowledge thereof, of the issuance of any stop order by the Commission suspending the effectiveness of such Registration Statement or the initiation or threatening of any proceeding for such purpose and promptly use its reasonable best efforts to prevent the issuance of any stop order or to obtain its withdrawal if such stop order should be issued;

3.1.8 advise each Holder of Registrable Securities covered by such Registration Statement, promptly after the Company receives notice thereof, of the time when such registration statement has been declared effective or a supplement to any Prospectus forming a part of such registration statement has been filed;

3.1.9 at least five (5) days prior to the filing of any Registration Statement or Prospectus or any amendment or supplement to such Registration Statement or Prospectus or any document that is to be incorporated by reference into such Registration Statement or Prospectus, furnish a copy thereof to each seller of such Registrable Securities or its counsel, including, without limitation, providing copies promptly upon receipt of any comment letters received with respect to any such Registration Statement or Prospectus;

3.1.10 notify the Holders at any time when a Prospectus relating to such Registration Statement is required to be delivered under the Securities Act, of the happening of any event as a result of which the Prospectus included in such Registration Statement, as then in effect, includes a Misstatement, and then to correct such Misstatement as set forth in [Section 3.4](#) hereof;

3.1.11 permit a representative of the Holders (such representative to be selected by a majority of the participating Holders), the Underwriters, if any, and any attorney or accountant retained by such Holders or Underwriter to participate, at each such person's own expense, in the preparation of the Registration Statement, and cause the Company's officers, directors and employees to supply all information reasonably requested by any such representative, Underwriter, attorney or accountant in connection with the Registration; provided, that such representatives or Underwriters enter into a confidentiality agreement, in form and substance reasonably satisfactory to the Company, prior to the release or disclosure of any such information;

3.1.12 obtain a "comfort" letter from the Company's independent registered public accountants in the event of an Underwritten Registration, in customary form and covering such matters of the type customarily covered by "comfort" letters as the managing Underwriter may reasonably request, and may be found reasonably satisfactory to a majority-in-interest of the participating Holders;

3.1.13 on the date the Registrable Securities are delivered for sale pursuant to such Registration, obtain an opinion and negative assurance letter, dated such date, of counsel representing the Company for the purposes of such Registration, addressed to the Holders, the placement agent or sales agent, if any, and the Underwriters, if any, covering such legal matters with respect to the Registration in respect of which such opinion is being given as the Holders, placement agent, sales agent, or Underwriter may reasonably request and as are customarily included in such opinions and negative assurance letters, and may be found reasonably satisfactory to a majority in interest of the participating Holders;

3.1.14 in the event of any Underwritten Offering, enter into and perform its obligations under an underwriting agreement, in usual and customary form, with the managing Underwriters of such offering;

3.1.15 make available to its security holders, as soon as reasonably practicable, an earnings statement covering the period of at least twelve (12) months beginning with the first day of the Company's first full calendar quarter after the effective date of the Registration Statement which satisfies the provisions of Section 11(a) of the Securities Act and Rule 158 thereunder (or any successor rule promulgated thereafter by the Commission);

3.1.16 if the Registration involves the Registration of Registrable Securities involving gross proceeds in excess of \$25,000,000, use its reasonable efforts to make available senior executives of the Company to participate in customary "road show" presentations that may be reasonably requested by the Underwriter in any Underwritten Offering; and

3.1.17 otherwise, in good faith, cooperate reasonably with, and take such customary actions as may reasonably be requested by the Holders, in connection with such Registration.

**Section 3.2 Registration Expenses.** Except as otherwise provided herein, the Registration Expenses of all Registrations shall be borne by the Company. It is acknowledged by the Holders that the Holders shall bear all

incremental selling expenses relating to the sale of Registrable Securities, such as Underwriters' commissions and discounts, brokerage fees, Underwriter marketing costs and, other than as set forth in the definition of "Registration Expenses," all reasonable fees and expenses of any legal counsel representing the Holders.

**Section 3.3 Requirements for Participation in Underwritten Offerings.** No person or entity may participate in any Underwritten Offering for equity securities of the Company pursuant to a Registration initiated by the Company hereunder unless such person or entity (i) agrees to sell such person's or entity's securities on the basis provided in any underwriting arrangements approved by the Company and (ii) completes and executes all customary questionnaires, powers of attorney, indemnities, lock-up agreements, underwriting agreements and other customary documents as may be reasonably required under the terms of such underwriting arrangements.

**Section 3.4 Suspension of Sales; Adverse Disclosure.**

3.4.1 The Company shall be entitled to postpone and suspend the effectiveness or use of the Registration Statement for a reasonable period of time, not to exceed 90 calendar days in any 360-day period (i) during any customary blackout or similar period or as permitted hereunder and (ii) as may be necessary in connection with the preparation and filing of a post-effective amendment to the Registration Statement following the filing of the Issuer's Annual Report on Form 10-K for its first completed fiscal year.

3.4.2 Upon receipt of written notice from the Company that a Registration Statement or Prospectus contains a Misstatement, each of the Holders shall forthwith discontinue disposition of Registrable Securities until such Holder has received copies of a supplemented or amended Prospectus correcting the Misstatement (it being understood that the Company hereby covenants to prepare and file such supplemented or amended Prospectus as soon as practicable after the time of such notice), or until he, she or it is advised in writing by the Company that the use of the Prospectus may be resumed. If the filing, initial effectiveness or continued use of a Registration Statement in respect of any Registration at any time would require the Company to make an Adverse Disclosure or would require the inclusion in such Registration Statement of financial statements that are unavailable to the Company for reasons beyond the Company's control, the Company may, upon giving prompt written notice of such action to the Holders, delay the filing or initial effectiveness of, or suspend use of, such Registration Statement for the shortest period of time, but in no event more than thirty (30) days, determined in good faith by the Company to be necessary for such purpose. In the event the Company exercises its rights under the preceding sentence, the Holders agree to suspend, immediately upon their receipt of the notice referred to above, their use of the Prospectus relating to any Registration in connection with any sale or offer to sell Registrable Securities. The Company shall immediately notify the Holders of the expiration of any period during which it exercised its rights under this [Section 3.4](#), and upon the expiration of such period the Holders shall be entitled to resume the use of any such Prospectus in connection with any sale or offer to sell Registrable Securities, and upon the expiration of such period the Holders shall be entitled to resume the use of any such Prospectus in connection with any sale or offer to sell Registrable Securities.

**Section 3.5 Reporting Obligations.** As long as any Holder shall own Registrable Securities, the Company, at all times while it shall be reporting under the Exchange Act, covenants to file timely (or obtain extensions in respect thereof and file within the applicable grace period) all reports required to be filed by the Company after the date hereof pursuant to [Sections 13\(a\)](#) or [15\(d\)](#) of the Exchange Act and to promptly furnish the Holders with true and complete copies of all such filings. The Company further covenants that it shall take such further action as any Holder may reasonably request, all to the extent required from time to time to enable such Holder to sell Registrable Securities held by such Holder without registration under the Securities Act within the limitation of the exemptions provided by Rule 144 promulgated under the Securities Act (or any successor rule promulgated thereafter by the Commission), including providing any legal opinions. Upon the request of any Holder, the Company shall deliver to such Holder a written certification of a duly authorized officer as to whether it has complied with such requirements.

**ARTICLE IV  
INDEMNIFICATION AND CONTRIBUTION**

**Section 4.1 Indemnification by the Company.** The Company agrees to indemnify, to the extent permitted by law, and hold harmless each Holder of Registrable Securities, its officers and directors and each person who controls such Holder (within the meaning of the Securities Act) from and against any losses, claims, damages, liabilities and expenses (including reasonable attorneys' fees) caused by any untrue or alleged untrue statement of material fact contained in any Registration Statement, Prospectus or preliminary Prospectus, or any amendment or supplement to any of them, or any omission or alleged omission of a material fact required to be stated therein or necessary to make the statements therein not misleading, or any violation by the Company of the Securities Act or any rule or regulation promulgated thereunder applicable to the Company and relating to action or inaction required of the Company in connection with any such registration, except insofar as the same is contained in any information furnished in writing to the Company by the Holder expressly for use therein. The Company also shall indemnify any Underwriter of the Registrable Securities, their officers and directors and each person who controls such Underwriter (within the meaning of the Securities Act) on substantially the same basis as that of the indemnification of the Holder provided in this [Section 4.1](#).

**Section 4.2 Indemnification by Holders of Registrable Securities.** In connection with any Registration Statement in which a Holder of Registrable Securities is participating, such Holder shall furnish to the Company in writing such information and affidavits as the Company reasonably requests for use in connection with any such Registration Statement or Prospectus and, to the extent permitted by law, shall indemnify the Company, its directors and officers and agents and each person who controls the Company (within the meaning of the Securities Act) against any losses, claims, damages, liabilities and expenses (including without limitation reasonable attorneys' fees) resulting from any untrue statement of material fact contained in the Registration Statement, Prospectus or preliminary Prospectus or any amendment thereof or supplement thereto or any omission of a material fact required to be stated therein or necessary to make the statements therein not misleading, but only to the extent that such untrue statement or omission is contained in any information or affidavit so furnished in writing by such Holder expressly for use therein; provided, that the obligation to indemnify shall be several, not joint and several, among such Holders of Registrable Securities, and the liability of each such Holder of Registrable Securities shall be in proportion to and limited to the net proceeds received by such Holder from the sale of Registrable Securities pursuant to such Registration Statement. Each Holder shall indemnify any Underwriter of Registrable Securities sold by such Holder, their officers, directors and each person who controls such Underwriters (within the meaning of the Securities Act) to the same extent as provided in the foregoing with respect to indemnification of the Company.

**Section 4.3 Conduct of Indemnification Proceedings.** Any person entitled to indemnification herein shall (i) give prompt written notice to the indemnifying party of any claim with respect to which it seeks indemnification (provided that the failure to give prompt notice shall not impair any person's right to indemnification hereunder to the extent such failure has not materially prejudiced the indemnifying party) and (ii) unless in such indemnified party's reasonable judgment a conflict of interest between such indemnified and indemnifying parties may exist with respect to such claim, permit such indemnifying party to assume the defense of such claim with counsel reasonably satisfactory to the indemnified party. If such defense is assumed, the indemnifying party shall not be subject to any liability for any settlement made by the indemnified party without its consent (but such consent shall not be unreasonably withheld). An indemnifying party who is not entitled to, or elects not to, assume the defense of a claim shall not be obligated to pay the fees and expenses of more than one counsel for all parties indemnified by such indemnifying party with respect to such claim, unless in the reasonable judgment of any indemnified party a conflict of interest may exist between such indemnified party and any other of such indemnified parties with respect to such claim. No indemnifying party shall, without the consent of the indemnified party, consent to the entry of any judgment or enter into any settlement which cannot be settled in all respects by the payment of money (and such money is so paid by the indemnifying party pursuant to the terms of such settlement) or which settlement does not include as an unconditional term thereof the giving by the claimant or plaintiff to such indemnified party of a release from all liability in respect to such claim or litigation.

**Section 4.4 Survival.** The indemnification provided for under this Agreement shall remain in full force and effect regardless of any investigation made by or on behalf of the indemnified party or any officer, director or controlling person of such indemnified party and shall survive the transfer of securities. The Company and each Holder of Registrable Securities participating in an offering also agrees to make such provisions as are reasonably requested by any indemnified party for contribution to such party in the event the Company's or such Holder's indemnification is unavailable for any reason.

**Section 4.5 Contribution.** If the indemnification provided under Section 4.1 hereof from the indemnifying party is unavailable or insufficient to hold harmless an indemnified party in respect of any losses, claims, damages, liabilities and expenses referred to herein, then the indemnifying party, in lieu of indemnifying the indemnified party, shall contribute to the amount paid or payable by the indemnified party as a result of such losses, claims, damages, liabilities and expenses in such proportion as is appropriate to reflect the relative fault of the indemnifying party and the indemnified party, as well as any other relevant equitable considerations. The relative fault of the indemnifying party and indemnified party shall be determined by reference to, among other things, whether any action in question, including any untrue or alleged untrue statement of a material fact or omission or alleged omission to state a material fact, was made by, or relates to information supplied by, such indemnifying party or indemnified party, and the indemnifying party's and indemnified party's relative intent, knowledge, access to information and opportunity to correct or prevent such action; provided, that the liability of any Holder under this Section 4.5 shall be limited to the amount of the net proceeds received by such Holder in such offering giving rise to such liability. The amount paid or payable by a party as a result of the losses or other liabilities referred to above shall be deemed to include, subject to the limitations set forth in Sections 4.1, 4.2 and 4.3 above, any legal or other fees, charges or expenses reasonably incurred by such party in connection with any investigation or proceeding. The parties hereto agree that it would not be just and equitable if contribution pursuant to this Section 4.5 were determined by pro rata allocation or by any other method of allocation, which does not take account of the equitable considerations referred to in this Section 4.5. No person guilty of fraudulent misrepresentation (within the meaning of Section 11(f) of the Securities Act) shall be entitled to contribution pursuant to this Section 4.5 from any person who was not guilty of such fraudulent misrepresentation.

## ARTICLE V RULE 144 and 145

**Section 5.1 Rule 144 and 145.** The Company covenants that it shall file any reports required to be filed by it under the Securities Act and the Exchange Act and shall take such further action as any Holders holding Registrable Securities may reasonably request, all to the extent required from time to time to enable such Holders to sell Registrable Securities without registration under the Securities Act within the limitation of the exemptions provided by Rule 144 and 145 under the Securities Act, as such Rule 144 and 145 may be amended from time to time, or any similar rule or regulation hereafter adopted by the SEC.

## ARTICLE VI GENERAL PROVISIONS

**Section 6.1 Entire Agreement.** This Agreement (including Schedule A hereto) constitutes the entire understanding and agreement between the parties as to the matters covered herein and supersedes and replaces any prior understanding, agreement or statement of intent, in each case, written or oral, of any and every nature with respect thereto.

**Section 6.2 Notices.** Any notice or other communication required or permitted to be delivered to any party under this Agreement shall be in writing and shall be deemed properly delivered, given and received (a) upon receipt when delivered by hand, (b) upon transmission, if sent by facsimile or electronic transmission (in each case with receipt verified by electronic confirmation), or (c) one (1) Business Day after being sent by courier or express delivery service, specifying next day delivery, with proof of receipt. The addresses, email addresses and

facsimile numbers for such notices and communications are those set forth on the signature pages hereof, or such other address, email address or facsimile numbers as may be designated in writing hereafter, in the same manner, by any such person.

**Section 6.3 Assignment; No Third-Party Beneficiaries.** This Agreement and the rights, duties and obligations of the Company hereunder may not be assigned or delegated by the Company in whole or in part. This Agreement and the rights, duties and obligations of the Holders hereunder may be freely assigned or delegated by such Holder in conjunction with and to the extent of any transfer of Common Stock by any such Holder. This Agreement and the provisions hereof shall be binding upon and shall inure to the benefit of each of the parties and the permitted assigns of the applicable Holder or of any assignee of the applicable Holder. This Agreement is not intended to confer any rights or benefits on any persons that are not party hereto other than as expressly set forth in [Article 4](#) and this [Section 6.3](#). No assignment by any party hereto of such party's rights, duties and obligations hereunder shall be binding upon or obligate the Company unless and until the Company shall have received (i) written notice of such assignment and (ii) the written agreement of the assignee, in a form reasonably satisfactory to the Company, to be bound by the terms and provisions of this Agreement (which may be accomplished by an addendum or certificate of joinder to this Agreement).

**Section 6.4 Counterparts.** This Agreement may be executed in one or more counterparts, all of which shall be considered one and the same agreement and shall become effective when one or more counterparts have been signed by each of the parties and delivered to the other parties, it being understood that all parties need not sign the same counterpart and such counterparts may be delivered by the parties hereto via facsimile or electronic transmission.

**Section 6.5 Amendment; Waiver.** This Agreement may be amended or modified, and any provision hereof may be waived, in whole or in part, at any time pursuant to an agreement in writing executed by the Company and Holders holding a majority of the Registrable Securities at such time; provided, however, that notwithstanding the foregoing, any amendment hereto or waiver hereof that adversely affects one Holder, solely in his, her or its capacity as a holder of the shares of capital stock of the Company, in a manner that is materially different from the other Holders (in such capacity) shall require the consent of the Holder so affected. Any failure by any party at any time to enforce any of the provisions of this Agreement shall not be construed a waiver of such provision or any other provisions hereof.

**Section 6.6 Severability.** In the event that any provision of this Agreement or the application thereof becomes or is declared by a court of competent jurisdiction to be illegal, void or unenforceable, the remainder of this Agreement will continue in full force and effect and the application of such provision to other persons or circumstances will be interpreted so as reasonably to effect the intent of the parties hereto.

**Section 6.7 Governing Law; Venue.** This Agreement shall be governed by, interpreted under, and construed in accordance with the internal laws of the State of Delaware applicable to agreements made and to be performed within the State of Delaware, without giving effect to any choice-of-law provisions thereof that would compel the application of the substantive laws of any other jurisdiction. All legal actions and proceedings arising out of or relating to this Agreement or the transactions contemplated hereby (each, an "**Action**") shall be heard and determined exclusively in any Delaware Chancery Court; provided, that if jurisdiction is not then available in the Delaware Chancery Court, then any such legal Action may be brought in any federal court located in the State of Delaware or any other Delaware state court. The parties hereto hereby (x) irrevocably submit to the exclusive jurisdiction of the aforesaid courts for themselves and with respect to their respective properties for the purpose of any Action arising out of or relating to this Agreement brought by any party hereto, and (y) agree not to commence any Action relating thereto except in the courts described above in Delaware, other than with respect to any appellate court thereof and other than Actions in any court of competent jurisdiction to enforce any judgment, decree or award rendered by any such court in Delaware as described herein. Each of the parties further agrees that notice as provided herein shall constitute sufficient service of process and the parties further waive any argument that such service is insufficient. Nothing in this Agreement will affect the right of any party to this Agreement to serve process in any other manner permitted by Law. Each of the parties irrevocably and unconditionally waives, and agrees not to assert, by way of motion or as a defense, counterclaim or otherwise, in

any Action arising out of or relating to this Agreement or the transactions contemplated hereby, (i) any claim that he, she or it is not personally subject to the jurisdiction of the courts in Delaware as described herein for any reason, (ii) that he, she or it or his, her or its property is exempt or immune from jurisdiction of any such court or from any legal process commenced in such courts (whether through service of notice, attachment prior to judgment, attachment in aid of execution of judgment, execution of judgment or otherwise) and (iii) that (A) the Action in any such court is brought in an inconvenient forum, (B) the venue of such Action is improper or (C) this Agreement, or the subject matter hereof, may not be enforced in or by such courts.

**Section 6.8. WAIVER OF JURY TRIAL.** EACH OF THE PARTIES HERETO HEREBY WAIVES TO THE FULLEST EXTENT PERMITTED BY APPLICABLE LAW ANY RIGHT HE, SHE OR IT MAY HAVE TO A TRIAL BY JURY WITH RESPECT TO ANY LITIGATION DIRECTLY OR INDIRECTLY ARISING OUT OF, UNDER OR IN CONNECTION WITH THIS AGREEMENT OR THE TRANSACTIONS CONTEMPLATED HEREBY. EACH OF THE PARTIES HERETO (I) CERTIFIES THAT NO REPRESENTATIVE, AGENT OR ATTORNEY OF ANY OTHER PARTY HAS REPRESENTED, EXPRESSLY OR OTHERWISE, THAT SUCH OTHER PARTY WOULD NOT, IN THE EVENT OF LITIGATION, SEEK TO ENFORCE THAT FOREGOING WAIVER AND (II) ACKNOWLEDGES THAT HE, SHE, IT AND THE OTHERS HERETO HAVE BEEN INDUCED TO ENTER INTO THIS AGREEMENT BY, AMONG OTHER THINGS, THE MUTUAL WAIVERS AND CERTIFICATIONS IN THIS SECTION 6.8.

**Section 6.9 Specific Performance.** Each party acknowledges and agrees that the other parties hereto would be irreparably harmed and would not have any adequate remedy at law in the event that any of the provisions of this Agreement were not performed by such first party in accordance with their specific terms or were otherwise breached by such first party. Accordingly, each party agrees that the other parties hereto shall be entitled to an injunction or injunctions to prevent breaches of this Agreement and to enforce specifically the terms and provisions of this Agreement, this being in addition to any other remedy to which such parties are entitled at law or in equity.

[Signature Page Follows.]

IN WITNESS WHEREOF, each of the parties has executed this Agreement as of the date first written above.

**COMPANY:**

GIGCAPITAL5, INC.

By: \_\_\_\_\_

Name:

Title:

Address for Notice:

[Signature Page to Registration Rights Agreement]



IN WITNESS WHEREOF, each of the undersigned has executed this Agreement as of the date first written above.

**HOLDER:**

[NAME]

By: \_\_\_\_\_

Name: \_\_\_\_\_

Title: \_\_\_\_\_

Address for Notice:

\_\_\_\_\_

\_\_\_\_\_

\_\_\_\_\_

Telephone No.: \_\_\_\_\_

Facsimile No.: \_\_\_\_\_

Email Address: \_\_\_\_\_

[Signature Page to Registration Rights Agreement]

## LOCK-UP AGREEMENT

This Lock-Up Agreement (this "Agreement") is made and entered into as of [●], 2023, by and among GigCapital5, Inc., a Delaware corporation ("GigCapital5"), QT Imaging, Inc., a Delaware corporation (the "Company"), and those equityholders of the Company listed on the signature pages hereto (each, a "Lock-Up Party" and, collectively, the "Lock-Up Parties"). Capitalized terms used but not otherwise defined herein shall have the respective meanings ascribed to such terms in the Business Combination Agreement (as defined below).

## RECITALS

WHEREAS, on December 8, 2022, GigCapital5, QTI Merger Sub, Inc., a Delaware corporation and a wholly-owned direct subsidiary of GigCapital5 ("Merger Sub"), and the Company, entered into a Business Combination Agreement (the "Business Combination Agreement"), pursuant to which, among other things, Merger Sub will merge with and into the Company (the "Merger"), with the Company surviving the merger as a wholly-owned subsidiary of GigCapital5 upon the terms and subject to the conditions set forth in the Business Combination Agreement;

WHEREAS, each Lock-Up Party agrees to enter into this Agreement with respect to all Lock-Up Securities (as defined below) that such Lock-Up Party now or hereafter Beneficially Owns or owns of record;

WHEREAS, each of GigCapital5, the Company and each Lock-Up Party has determined that it is in their best interests to enter into this Agreement; and

WHEREAS, each Lock-Up Party understands and acknowledges that GigCapital5 and the Company are entering into the Business Combination Agreement in reliance upon such Lock-Up Party's execution and delivery of this Agreement.

NOW, THEREFORE, in consideration of the foregoing and the respective representations, warranties, covenants and agreements set forth below and for other good and valuable consideration, the receipt and sufficiency of which are hereby acknowledged, the parties hereto, intending to be legally bound, do hereby agree as follows:

1. Definitions. When used in this Agreement, the following terms in all of their tenses, cases and correlative forms shall have the meanings assigned to them in this Section 1 or elsewhere in this Agreement.

"Affiliate" of a specified person means a Person who, directly or indirectly through one or more intermediaries, controls, is controlled by, or is under common control with, such specified Person (*provided* that if a Lock-Up Party is a venture capital, private equity or angel fund, no portfolio company of such Lock-Up Party will be deemed an Affiliate of such Lock-Up Party).

"Beneficially Own" means, with regard to any securities, having "beneficial ownership" of such securities for purposes of Rule 13d-3 or 13d-5 under the Exchange Act. Similar terms such as "Beneficial Ownership" and "Beneficial Owner" have the corresponding meanings.

"Expiration Time" shall mean the earliest to occur of (a) the Closing Date, (b) such date as the Business Combination Agreement shall be validly terminated in accordance with Article IX thereof, and (c) the effective date of a written agreement of the parties hereto terminating this Agreement.

"Family Member" means with respect to any individual, a spouse, lineal descendant (whether natural or adopted) or spouse of a lineal descendant of such individual or any trust created for the benefit of such individual or of which any of the foregoing is a beneficiary.

“GigCapital5 Common Stock” means GigCapital5’s common stock, par value \$0.0001 per share.

“GigCapital5 Preferred Stock” means GigCapital5’s preferred stock, par value \$0.0001 per share.

“GigCapital5 Securities” means (a) any shares of GigCapital5 Preferred Stock, (b) any shares of GigCapital5 Common Stock, (c) any shares of GigCapital5 Common Stock issued or issuable upon the exercise of any warrant or other right to acquire shares of such GigCapital5 Common Stock and (d) any equity securities of GigCapital5 that may be issued or distributed or be issuable with respect to the securities referred to in clauses (b) or (c) by way of conversion, dividend, stock split or other distribution, merger, consolidation, exchange, recapitalization or reclassification or similar transaction.

“Governmental Authority” means any United States federal, state, county, municipal or other local or non-United States government, governmental, regulatory or administrative authority, agency, instrumentality or commission or any court, tribunal, or judicial or arbitral body.

“Law” means any applicable federal, national, state, county, municipal, provincial, local, foreign or multinational statute, constitution, common law, ordinance, code, decree, order, judgment, rule, binding regulation, ruling or requirement issued, enacted, adopted, promulgated, implemented or otherwise put into effect by or under the authority of any Governmental Authority.

“Lock-Up Securities” means any GigCapital5 Securities Beneficially Owned by a Lock-Up Party as of immediately following the Closing Date, other than (i) any security received pursuant to an incentive plan adopted by GigCapital5 on or after the Closing Date, or (ii) any GigCapital5 Securities acquired in open market transactions.

“Permitted Transferee” means with respect to any Person, (a) in the case of an individual: (i) any Family Member of such Person by bona fide gift, (ii) any Affiliate of any Family Member of such Person or to a trust, the beneficiary of which is a Family Member or an Affiliate of such Person, or to a charitable organization, (iii) a Person by virtue of the laws of descent and distribution upon death of such Person, (iv) a Person pursuant to a qualified domestic relations order, and (b) in the case of an entity, (i) any Affiliate of such Person or to any investment fund or other entity controlled or managed by such Person, (ii) if the undersigned is a corporation, partnership, limited liability company or other business entity, its stockholders, partners, members or other equityholders, and (c) the Company or GigCapital5 in connection with the repurchase of shares of GigCapital5 Common Stock issued pursuant to equity awards granted under a stock incentive plan or other equity award plan.

“Person” means an individual, corporation, partnership, limited partnership, limited liability company, syndicate, person (including a “person” as defined in Section 13(d)(3) of the Exchange Act), trust, association or entity or government, political subdivision, agency or instrumentality of a government.

“Transfer” means, excluding entry into this Agreement and the Business Combination Agreement and the consummation of the transactions contemplated hereby and thereby, any (a) sale of, offer to sell, contract or agreement to sell, hypothecate, pledge, grant of any option to purchase or otherwise dispose of or agreement to dispose of, directly or indirectly, or establishment or increase of a put equivalent position or liquidation with respect to or decrease of a call equivalent position within the meaning of Section 16 of the Exchange Act and the rules and regulations promulgated thereunder with respect to, any security, (b) entry into any swap or other arrangement that transfers to another, in whole or in part, any of the economic consequences of ownership of any security, whether any such transaction is to be settled by delivery of such securities, in cash or otherwise, or (c) the public announcement of any intention to effect any transaction specified in clause (a) or (b).

## 2. Lock-Up.

2.1 Lock-Up. Each Lock-Up Party severally, and not jointly, agrees with GigCapital5 not to effect any Transfer, or make a public announcement of any intention to effect such Transfer, of any Lock-Up Securities Beneficially Owned or otherwise held by such Lock-Up Party during the Lock-Up Period (as defined below); *provided*, that such prohibition shall not apply to Transfers permitted pursuant to Section 2.2. The “Lock-Up Period” shall be the period commencing on the Closing Date and ending on the date that is the earlier to occur of:

(a) six (6) months following the Closing Date; (b) subsequent to the Closing, the date on which the reported closing price of one share of GigCapital5 Common Stock quoted on The Nasdaq Stock Market LLC, the New York Stock Exchange or the NYSE American (or the exchange on which the shares of GigCapital5 Common Stock are then listed) equals or exceeds eleven dollars and fifty cents (\$11.50) per share (as adjusted for stock splits, stock dividends, reorganizations, recapitalizations and the like occurring after the Closing Date) for any twenty (20) Trading Days (as defined below) within any thirty (30) consecutive Trading Day period commencing at least ninety (90) days after the Closing Date; and (c) subsequent to the Closing, the date on which GigCapital5 completes a liquidation, merger, stock exchange or other similar transaction that results in all of GigCapital5's stockholders having the right to exchange their GigCapital5 Securities for cash, securities or other property. "Trading Day," means a day on which shares of GigCapital5 Common Stock are actually traded on the principal securities exchange or securities market on which shares of GigCapital5 Common Stock are then traded; *provided, however*, that if the GigCapital5 Common Stock is not so listed or admitted for trading, Trading Day means a Business Day. For the avoidance of any doubt, each Lock-Up Party shall retain all of his, her or its rights as a stockholder of GigCapital5 during the Lock-Up Period, including the right to vote, and to receive any dividends and distributions in respect of, any Lock-Up Securities.

2.2 Permitted Transfers. Notwithstanding anything to the contrary contained in this Agreement, during the Lock-Up Period, each Lock-Up Party may Transfer, without the consent of GigCapital5, any of such Lock-Up Party's Lock-Up Securities (a) to any of such Lock-Up Party's Permitted Transferees, upon written notice to GigCapital5 or (b) pursuant to any liquidation, merger, stock exchange or other similar transaction which results in all of GigCapital5's stockholders having the right to exchange their GigCapital5 Securities for cash, securities or other property subsequent to the Merger; *provided*, that in connection with any Transfer of such Lock-Up Securities, the restrictions and obligations contained in Section 2.1 and this Section 2.2 will continue to apply to such Lock-Up Securities after any Transfer of such Lock-Up Securities and such transferee shall execute a lock-up agreement substantially in the form of this Agreement for the balance of the Lock-Up Period. Notwithstanding the foregoing provisions of this Section 2.2, a Lock-Up Party may (i) not make a Transfer to a Permitted Transferee if such Transfer has as a purpose the avoidance of or is otherwise undertaken in contemplation of avoiding the restrictions on Transfers in this Agreement (it being understood that the purpose of this provision includes prohibiting the Transfer to a Permitted Transferee (A) that has been formed to facilitate a material change with respect to who or which entities Beneficially Own the Lock-Up Securities, or (B) followed by a change in the relationship between the Lock-Up Party and the Permitted Transferee (or a change of control of such Lock-Up Party or Permitted Transferee) after the Transfer with the result and effect that the Lock-Up Party has indirectly made a Transfer of Lock-Up Securities by using a Permitted Transferee, which Transfer would not have been directly permitted under this Section 2 had such change in such relationship occurred prior to such Transfer), or (ii) enter into a written plan meeting the requirements of Rule 10b5-1 under the Exchange Act after the date of this Agreement relating to the sale of the undersigned's Lock-Up Securities, *provided* that (A) the securities subject to such plan may not be sold until after the expiration of the Lock-Up Period and (B) the Company shall not be required to effect, and the undersigned shall not effect or cause to be effected, any public filing, report or other public announcement regarding the establishment of the trading plan.

3. Confidentiality. Until the Expiration Time, each Lock-Up Party will and will direct his, her or its Affiliates to keep confidential and not disclose any non-public information relating to GigCapital5 or the Company and their respective subsidiaries, including the existence or terms of, or transactions contemplated by, this Agreement, the Business Combination Agreement or the other Transaction Documents, except to the extent that such information (i) was, is or becomes generally available to the public after the date hereof other than as a result of a disclosure by such Lock-Up Party in breach of this Section 3, (ii) is, was or becomes available to such Lock-Up Party on a non-confidential basis from a source other than GigCapital5 or the Company, or (iii) is or was independently developed by such Lock-Up Party after the date hereof. Notwithstanding the foregoing, such information may be disclosed to the extent required to be disclosed in a judicial or administrative proceeding, or otherwise required to be disclosed by applicable Law (including complying with any oral or written questions, interrogatories, requests for information or documents, subpoena, civil investigative demand or similar process to which such disclosing party is subject), *provided* that such Lock-Up Party gives GigCapital5 or the Company, as applicable, prompt notice of such request(s) or requirement(s), to the extent practicable (and not prohibited by Law), so that

GigCapital5 or the Company may seek, at its expense, an appropriate protective order or similar relief (and such Lock-Up Party shall reasonably cooperate with such efforts it being understood that such obligation to reasonably cooperate does not require a Lock-Up Party to himself, herself or itself commence litigation regarding such protective order or similar relief).

4. Representations and Warranties of the Lock-Up Parties. Each Lock-Up Party hereby represents and warrants, severally and not jointly, to the Company and GigCapital5 as follows:

4.1 Due Authority. Such Lock-Up Party has the full power and authority to execute and deliver this Agreement and perform his, her or its obligations hereunder. If such Lock-Up Party is an individual, the signature to this agreement is genuine and such Lock-Up Party has legal competence and capacity to execute the same. This Agreement has been duly and validly executed and delivered by such Lock-Up Party and, assuming due execution and delivery by the other parties hereto, constitutes a legal, valid and binding obligation of such Lock-Up Party, enforceable against such Lock-Up Party in accordance with its terms, except as limited by applicable bankruptcy, insolvency, reorganization, moratorium and other laws of general application affecting enforcement of creditors' rights generally, and by general equitable principles.

4.2 No Conflict; Consents.

(a) The execution and delivery of this Agreement by such Lock-Up Party does not, and the performance by such Lock-Up Party of the obligations under this Agreement and the compliance by such Lock-Up Party with any provisions hereof do not and will not: (i) conflict with or violate any Law applicable to such Lock-Up Party, (ii) if such Lock-Up Party is an entity, conflict with or violate the certificate of incorporation or bylaws or any equivalent Organizational Documents of such Lock-Up Party, or (iii) result in any breach of, or constitute a default (or an event, which with notice or lapse of time or both, would become a default) under, or give to others any rights of termination, amendment, acceleration or cancellation of, or result in the creation of a lien on any of the securities of the Company owned by such Lock-Up Party pursuant to any note, bond, mortgage, indenture, contract, agreement, lease, license, permit, franchise or other instrument or obligation to which such Lock-Up Party is a party or by which such Lock-Up Party is otherwise bound, except, in the case of clauses (i) and (iii), as would not reasonably be expected, individually or in the aggregate, to materially impair the ability of such Lock-Up Party to perform his, her or its obligations hereunder or to consummate the transactions contemplated hereby.

(b) The execution and delivery of this Agreement by such Lock-Up Party does not, and the performance of this Agreement by such Lock-Up Party will not, require any consent, approval, authorization or permit of, or filing or notification to, or expiration of any waiting period by any Governmental Authority, other than those set forth as conditions to closing in the Business Combination Agreement.

4.3 Absence of Litigation. As of the date hereof, there is no litigation, suit, claim, charge, grievance, action, proceeding, audit or investigation by or before any Governmental Authority (an "Action") pending against, or, to the knowledge of such Lock-Up Party, threatened against such Lock-Up Party that would reasonably be expected to materially impair the ability of such Lock-Up Party to perform his, her or its obligations hereunder or to consummate the transactions contemplated hereby.

4.4 Absence of Conflicting Agreements. Such Lock-Up Party has not entered into any agreement, arrangement or understanding that is otherwise materially inconsistent with, or would materially interfere with, or prohibit or prevent him, her or it from satisfying, his, her or its obligations pursuant to this Agreement.

5. Fiduciary Duties. The covenants and agreements set forth herein shall not prevent any designee of any Lock-Up Party from serving on the Board of Directors or as an officer of the Company or from taking any action, subject to the provisions of the Business Combination Agreement, while acting in such designee's capacity as a director or officer of the Company. Each Lock-Up Party is entering into this Agreement solely in his, her or its capacity as the anticipated owner of GigCapital5 Securities following the consummation of the Merger.

6. Termination. This Agreement shall terminate upon the earlier of: (i) termination of the Business Combination Agreement in accordance with its terms; or (ii) completion of the Lock-Up as specified in Section 2.1 of this Agreement. Upon termination of this Agreement, none of the parties hereto shall have any further obligations or liabilities under this Agreement; *provided*, that nothing in this Section 6 shall relieve any party hereto of liability for any willful material breach of this Agreement prior to its termination.

7. Miscellaneous.

7.1 Severability. In the event that any term, provision, covenant or restriction of this Agreement, or the application thereof, is held to be illegal, invalid or unenforceable under any present or future Law: (a) such provision will be fully severable; (b) this Agreement will be construed and enforced as if such illegal, invalid or unenforceable provision had never comprised a part hereof; (c) the remaining provisions of this Agreement will remain in full force and effect and will not be affected by the illegal, invalid or unenforceable provision or by its severance therefrom; and (d) in lieu of such illegal, invalid or unenforceable provision, there will be added automatically as a part of this Agreement a legal, valid and enforceable provision as similar in terms of such illegal, invalid or unenforceable provision as may be possible.

7.2 Non-survival of Representations and Warranties. None of the representations or warranties in this Agreement or in any schedule, instrument or other document delivered pursuant to this Agreement shall survive the Expiration Time.

7.3 Assignment. Neither party hereto may assign, directly or indirectly, including, through any merger, acquisition, sale of all or substantially all shares/assets or by operation of Law, either this Agreement or any of his, her or its rights, interests or obligations hereunder without the prior written approval of the other parties hereto, except with respect to a Transfer completed in accordance with Section 2.2. Subject to the first sentence of this Section 7.3, this Agreement shall be binding upon and shall inure to the benefit of the parties hereto and their respective successors and permitted assigns. Any assignment in violation of this Section 7.3 shall be void ab initio.

7.4 Amendments and Modifications. This Agreement may be amended by the parties hereto at any time by execution of an instrument in writing signed by (a) GigCapital5, (b) the Company and (c) (i) by Lock-Up Parties holding at least fifty percent (50%) of the Lock-Up Securities (assuming the hypothetical exercise of all then-outstanding warrants and options that are Lock-Up Securities) that are then subject to this Agreement, and any such amendment shall be binding on all the Lock-Up Parties; *provided, however*, that in no event shall the obligation of any Lock-Up Party hereunder be materially increased without the prior written consent of such Lock-Up Party, unless such amendment applies to all Lock-Up Parties in the same fashion; *provided, further, however*, that (A) if this Agreement, or any other lock-up agreement signed by a stockholder of the Company in connection with the transactions contemplated hereby or under the Business Combination Agreement, is amended, modified or waived in a manner favorable to any Lock-Up Party or such shareholder, and such amendment, modification or waiver would be favorable to any other Lock-Up Party, this Agreement shall be automatically amended in the same manner with respect to such other Lock-Up Party (and GigCapital5 shall provide prompt notice thereof to all Lock-Up Parties), and (B) if any Lock-Up Party or such shareholder is released from any or all of the lock-up restrictions under this Lock-Up Agreement or such other lock-up agreement, each other Lock-Up Party shall automatically be contemporaneously and proportionately released from the lock-up restrictions hereunder (which, for the avoidance of doubt, will include a release of the same percentage of such Lock-Up Party's Lock-Up Securities) and GigCapital5 shall provide prompt notice thereof to each Lock-Up Party.

7.5 Governing Law; WAIVER OF JURY TRIAL; Specific Performance.

(a) This Agreement and all Actions based upon, arising out of or relating to this Agreement or the transactions contemplated hereby shall be governed by, and construed in accordance with, the Laws of the State of Delaware.

(b) All legal actions and proceedings arising out of or relating to this Agreement shall be heard and determined exclusively in any Delaware Chancery Court; *provided*, that if jurisdiction is not then available

in the Delaware Chancery Court, then any such legal Action may be brought in any federal court located in the State of Delaware or any other Delaware state court. The parties hereto hereby (x) irrevocably submit to the exclusive jurisdiction of the aforesaid courts for themselves and with respect to their respective properties for the purpose of any Action arising out of or relating to this Agreement brought by any party hereto, and (y) agree not to commence any Action relating thereto except in the courts described above in Delaware, other than with respect to any appellate court thereof and other than Actions in any court of competent jurisdiction to enforce any judgment, decree or award rendered by any such court in Delaware as described herein. Each of the parties further agrees that notice as provided herein shall constitute sufficient service of process and the parties further waive any argument that such service is insufficient. Nothing in this Agreement will affect the right of any party to this Agreement to serve process in any other manner permitted by Law. Each of the parties irrevocably and unconditionally waives, and agrees not to assert, by way of motion or as a defense, counterclaim or otherwise, in any Action arising out of or relating to this Agreement or the transactions contemplated hereby, (i) any claim that he, she or it is not personally subject to the jurisdiction of the courts in Delaware as described herein for any reason, (ii) that he, she or it or his, her or its property is exempt or immune from jurisdiction of any such court or from any legal process commenced in such courts (whether through service of notice, attachment prior to judgment, attachment in aid of execution of judgment, execution of judgment or otherwise) and (iii) that (A) the Action in any such court is brought in an inconvenient forum, (B) the venue of such Action is improper or (C) this Agreement, or the subject matter hereof, may not be enforced in or by such courts.

(c) EACH OF THE PARTIES HERETO HEREBY WAIVES TO THE FULLEST EXTENT PERMITTED BY APPLICABLE LAW ANY RIGHT HE, SHE OR IT MAY HAVE TO A TRIAL BY JURY WITH RESPECT TO ANY LITIGATION DIRECTLY OR INDIRECTLY ARISING OUT OF, UNDER OR IN CONNECTION WITH THIS AGREEMENT OR THE TRANSACTIONS CONTEMPLATED HEREBY. EACH OF THE PARTIES HERETO (I) CERTIFIES THAT NO REPRESENTATIVE, AGENT OR ATTORNEY OF ANY OTHER PARTY HAS REPRESENTED, EXPRESSLY OR OTHERWISE, THAT SUCH OTHER PARTY WOULD NOT, IN THE EVENT OF LITIGATION, SEEK TO ENFORCE THAT FOREGOING WAIVER AND (II) ACKNOWLEDGES THAT HE, SHE, IT AND THE OTHERS HERETO HAVE BEEN INDUCED TO ENTER INTO THIS AGREEMENT BY, AMONG OTHER THINGS, THE MUTUAL WAIVERS AND CERTIFICATIONS IN THIS SECTION 7.5(C).

(d) The parties agree that irreparable damage would occur if any provision of this Agreement were not performed in accordance with the terms hereof, and, accordingly, that the parties shall be entitled to an injunction or injunctions to prevent breaches of this Agreement or to enforce specifically the performance of the terms and provisions hereof in the Court of Chancery of the State of Delaware, County of Newcastle, or, if that court does not have jurisdiction, any court of the United States located in the State of Delaware without proof of actual damages or otherwise, in addition to any other remedy to which they are entitled at Law or in equity as expressly permitted in this Agreement. Each of the parties hereby further waives (i) any defense in any action for specific performance that a remedy at Law would be adequate and (ii) any requirement under any Law to post security or a bond as a prerequisite to obtaining equitable relief.

7.6 Notices. All notices, requests, claims, demands and other communications hereunder shall be in writing and shall be given (and shall be deemed to have been duly given upon receipt) by delivery in person, by email or by registered or certified mail (postage prepaid, return receipt requested) to the respective parties at the following addresses (or at such other address for a party as shall be specified in a notice given in accordance with this Section 7.6):

(i) if to GigCapital5 prior to the Effective Time, to:

GigCapital5, Inc.  
1731 Embarcadero Road, Suite 200  
Palo Alto, CA 94303  
Attention: Dr. Raluca Dinu, President and Chief Executive Officer  
Dr. Avi S. Katz, Executive Chairman of the Board  
Email: \*\*\*, \*\*\*

with a copy to:

DLA Piper LLP (US)  
555 Mission Street, Suite 2400  
San Francisco, CA 94105  
Attention: Jeff Selman; John Maselli  
Email: [jeffrey.selman@us.dlapiper.com](mailto:jeffrey.selman@us.dlapiper.com); [john.maselli@us.dlapiper.com](mailto:john.maselli@us.dlapiper.com)

(ii) if to the Company prior to the Effective Time, to:

QT Imaging, Inc.  
3 Hamilton Landing, Suite 160  
Novato, California 94949  
Attention: Dr. John Klock, Chief Executive Officer  
Email: \*\*\*

with a copy to:

Seyfarth Shaw LLP  
975 F Street, NW  
Washington, DC 20004  
Attention: Andrew J. Sherman  
Email: [asherman@seyfarth.com](mailto:asherman@seyfarth.com)

(iii) if to the Company or GigCapital5 following the Effective Time, to:

QT Imaging Holdings, Inc.  
3 Hamilton Landing  
Suite 160  
Novato, CA 94949  
Attention: Dr. John C. Klock, Chief Executive Officer  
Email: \*\*\*

with a copy to:

DLA Piper LLP (US)  
555 Mission Street, Suite 2400  
San Francisco, CA 94105  
Attention: Jeff Selman; John Maselli  
Email: [jeffrey.selman@us.dlapiper.com](mailto:jeffrey.selman@us.dlapiper.com); [john.maselli@us.dlapiper.com](mailto:john.maselli@us.dlapiper.com)

with a copy to:

Seyfarth Shaw LLP  
975 F Street, NW  
Washington, DC 20004  
Attention: Andrew J. Sherman  
Email: [asherman@seyfarth.com](mailto:asherman@seyfarth.com)

(iv) if to a Lock-Up Party, to the address for notice set forth on such Lock-Up Party's signature page to this Agreement.



7.7 Entire Agreement; Third-Party Beneficiaries. This Agreement, together with the Business Combination Agreement and Transaction Documents, constitutes the entire agreement among the parties hereto with respect to the subject matter hereof and supersedes all prior agreements and undertakings, both written and oral, among the parties hereto, or any of them, with respect to the subject matter hereof. This Agreement shall be binding upon and inure solely to the benefit of each party, and nothing in this Agreement, express or implied, is intended to or shall confer upon any other person any benefit or remedy of any nature whatsoever under or by reason of this Agreement.

7.8 Counterparts. This Agreement may be executed and delivered (including by facsimile or portable document format (pdf) transmission) in one or more counterparts, and by the different parties in separate counterparts, each of which when executed shall be deemed to be an original but all of which taken together shall constitute one and the same agreement.

7.9 Effect of Headings. The descriptive headings contained in this Agreement are included for convenience of reference only and shall not affect in any way the meaning or interpretation of this Agreement.

7.10 Legal Representation. Each of the parties hereto agrees that he, she or it has been represented by independent counsel of his, her or its choice during the negotiation and execution of this Agreement and each party hereto and his, her or its counsel cooperated in the drafting and preparation of this Agreement and the documents referred to herein and, therefore, waive the application of any Law, regulation, holding or rule of construction providing that ambiguities in an agreement or other document will be construed against the party hereto drafting such agreement or document. Each Lock-Up Party acknowledges that DLA Piper LLP (US) is acting as counsel to GigCapital5 and Seyfarth Shaw LLP is acting as counsel to the Company in connection with the Business Combination Agreement and the transactions contemplated thereby, and that neither of such firms is acting as counsel to any Lock-Up Party.

7.11 Expenses. Except as provided in the Business Combination Agreement, all expenses incurred in connection with this Agreement and the transactions contemplated hereby shall be paid by the party incurring such expenses, whether or not the Merger or any other Transaction is consummated.

7.12 Further Assurances. At the request of GigCapital5 or the Company, in the case of any Lock-Up Party, or at the request of the Lock-Up Parties, in the case of GigCapital5, and without further consideration, each party shall execute and deliver or cause to be executed and delivered such additional documents and instruments and take such further action as may be reasonably necessary to consummate the transactions contemplated by this Agreement.

7.13 Waiver. No failure or delay on the part of any party to exercise any power, right, privilege or remedy under this Agreement shall operate as a waiver of such power, right, privilege or remedy; and no single or partial exercise of any such power, right, privilege or remedy shall preclude any other or further exercise thereof or of any other power, right, privilege or remedy. No party shall be deemed to have waived any claim available to such party arising out of this Agreement, or any power, right, privilege or remedy under this Agreement, unless the waiver of such claim, power, right, privilege or remedy is expressly set forth in a written instrument duly executed and delivered on behalf of such waiving party; and any such waiver shall not be applicable or have any effect except in the specific instance in which it is given.

7.14 Several Liability. The liability of the Lock-Up Parties hereunder is several (and not joint). Notwithstanding any other provision of this Agreement, in no event will any Lock-Up Party be liable for any other Lock-Up Party's breach of such other Lock-Up Party's representations, warranties, covenants, or agreements contained in this Agreement.

7.15 No Recourse. Notwithstanding anything to the contrary contained herein or otherwise, but without limiting any provision in the Business Combination Agreement, or the obligations of any Permitted Transferee under this Agreement, this Agreement may only be enforced against, and any claims or causes of action that may be based upon, arise out of or relate to this Agreement, or the negotiation, execution or performance of this

Agreement or the transactions contemplated hereby, may only be made against the entities and Persons that are expressly identified as parties to this Agreement in their capacities as such and no former, current or future stockholders, equity holders, controlling persons, directors, officers, employees, general or limited partners, members, managers, agents or affiliates of any party hereto, or any former, current or future direct or indirect stockholder, equity holder, controlling person, director, officer, employee, general or limited partner, member, manager, agent or affiliate of any of the foregoing (each, a "Non-Recourse Party") shall have any liability for any obligations or liabilities of the parties to this Agreement or for any claim (whether in tort, contract or otherwise) based on, in respect of, or by reason of, the transactions contemplated hereby or in respect of any oral representations made or alleged to be made in connection herewith. Without limiting the rights of any party against the other parties hereto, or the obligations of any Permitted Transferee under this Agreement, in no event shall any party or any of his, her or its affiliates seek to enforce this Agreement against, make any claims for breach of this Agreement against, or seek to recover monetary damages from, any Non-Recourse Party.

*[Signature pages follow.]*

IN WITNESS WHEREOF, the parties hereto have caused this Agreement to be executed as of the date first written above.

**GIGCAPITAL5, INC.,**  
a Delaware corporation

By: \_\_\_\_\_  
Name: Dr. Raluca Dinu  
Title: President and Chief Executive Officer

*Signature Page to Lock-Up Agreement*

IN WITNESS WHEREOF, the parties hereto have caused this Agreement to be executed as of the date first written above.

**QT IMAGING, INC.,**  
a Delaware corporation

By: \_\_\_\_\_  
Name:  
Title:

*Signature Page to Lock-Up Agreement*

IN WITNESS WHEREOF, the parties hereto have caused this Agreement to be executed as of the date first written above.

**LOCK-UP PARTIES:**

By: \_\_\_\_\_

Name:

Title:

Address for Notice:

*Signature Page to Lock-Up Agreement*

EXHIBIT E

AMENDED AND RESTATED CERTIFICATE OF INCORPORATION

OF

QT IMAGING, INC.

I.

The name of this corporation is QT Imaging, Inc. (the “*Corporation*”).

II.

The address of the registered office of the Corporation in the State of Delaware is 1209 Orange Street, Corporation Trust Center in the City of Wilmington, County of New Castle, State of Delaware, 19801. The name of the Corporation’s registered agent at such address is The Corporation Trust Company.

III.

The purpose of the Corporation is to engage in any lawful act or activity for which a corporation may be organized under the General Corporation Law of the State of Delaware (“*DGCL*”).

IV.

The Corporation is authorized to issue only one class of stock, to be designated Common Stock. The total number of shares of Common Stock presently authorized is Ten Thousand (10,000) shares, with each share having a par value of \$0.0001.

V.

A. The management of the business and the conduct of the affairs of the Corporation shall be vested in its board of directors (“*Board of Directors*”). The number of directors which shall constitute the whole board of Directors shall be fixed by the Board of Directors in the manner provided in the bylaws of the Corporation (“*Bylaws*”).

B. The Board of Directors is expressly empowered to adopt, amend or repeal the Bylaws of the Corporation. The stockholders shall also have power to adopt, amend or repeal the Bylaws; provided, however, that, in addition to any vote of the holders of any class or series of stock of the Corporation required by law or by this Certificate of Incorporation, such action by stockholders shall require the affirmative vote of the holders of at least a majority of the voting power of all of the then-outstanding shares of the capital stock of the Corporation entitled to vote generally in the election of directors, voting together as a single class.

VI.

A. To the fullest extent permitted by law, a director of the Corporation shall not be personally liable to the Corporation or its stockholders for monetary damages for breach of fiduciary duty as a director. If the DGCL or any other law of the State of Delaware is amended to authorize corporate action further eliminating or limiting the personal liability of directors, then the liability of a director of the Corporation shall be eliminated or limited to the fullest extent permitted by the DGCL, as so amended.

**B.** Any repeal or modification of this Article VI shall be prospective and shall not adversely affect any right or protection of a director of the Corporation existing at the time of, or increase the liability of any director with respect to any acts or omissions of such director occurring prior to, such repeal or modification.

**VII.**

**A.** To the fullest extent permitted by applicable law, the Corporation is authorized to provide indemnification of (and advancement of expenses to) directors, officers and agents of the Corporation (and any other persons to which DGCL permits the Corporation to provide indemnification) through Bylaw provisions, agreements with such agents or other persons, vote of stockholders or disinterested directors or otherwise, in excess of the indemnification and advancement otherwise permitted by Section 145 of the DGCL. Any amendment, repeal, or modification of the foregoing provisions will not adversely affect any right or protection of any director, officer or other agent of the Corporation existing at the time of such amendment, repeal or modification.

**VIII.**

The Corporation reserves the right to amend, alter, change or repeal any provision contained in this Certificate of Incorporation, in the manner now or hereafter prescribed by statute, and all rights conferred upon the stockholders herein are granted subject to this reservation.

**IX.**

The Corporation is to have perpetual existence.

IN WITNESS WHEREOF, the Corporation has caused this Amended and Restated Certificate to be duly executed and acknowledged in its name and on its behalf by an authorized officer as of [●], 2023.

QT IMAGING, INC.

By: \_\_\_\_\_  
Name:  
Title:

*[Signature Page to Amended and Restated Certificate of Incorporation]*



EXHIBIT F

SECOND AMENDED AND RESTATED  
CERTIFICATE OF INCORPORATION  
OF  
GIGCAPITAL5, INC.

[●], 2023

GigCapital5, Inc., a corporation organized and existing under the laws of the State of Delaware (the “*Corporation*”), DOES HEREBY CERTIFY AS FOLLOWS:

1. The name of the Corporation is “*GigCapital5, Inc.*” The original certificate of incorporation of the Corporation was filed with the Secretary of State of the State of Delaware on January 19, 2021, and an amended and restated certificate of incorporation was filed with the Secretary of State of the State of Delaware on September 23, 2021 (as amended to date, the “*Original Certificate*”).
2. This Second Amended and Restated Certificate of Incorporation (the “*Second Amended and Restated Certificate*”), which both restates and amends the provisions of the Original Certificate, was duly adopted in accordance with Sections 228, 242 and 245 of the General Corporation Law of the State of Delaware, as amended from time to time (the “*DGCL*”).
3. This Second Amended and Restated Certificate shall become effective on the date of filing with the Secretary of State of Delaware.
4. The text of the Original Certificate is hereby restated and amended in its entirety to read as follows:

ARTICLE I  
NAME

The name of the corporation is QTI Holdings, Inc. (the “*Corporation*”).

ARTICLE II  
PURPOSE

The purpose of the Corporation is to engage in any lawful act or activity for which corporations may be organized under the DGCL.

ARTICLE III  
REGISTERED AGENT

The address of the Corporation’s registered office in the State of Delaware is 1209 Orange Street, Corporation Trust Center in the City of Wilmington, County of New Castle, State of Delaware, 19801, and the name of the Corporation’s registered agent at such address is The Corporation Trust Company.

ARTICLE IV  
CAPITALIZATION

Section 4.1 Authorized Capital Stock. The total number of shares of all classes of capital stock which the Corporation is authorized to issue is 510,000,000 shares, consisting of (a) 500,000,000 shares of common stock, par value \$0.0001 per share (the “*Common Stock*”) and (b) 10,000,000 shares of preferred stock, par value \$0.0001 per share (the “*Preferred Stock*”).

Section 4.2 Preferred Stock. The Preferred Stock may be issued from time to time in one or more series. The Board of Directors of the Corporation (the “*Board*”) is hereby expressly authorized to provide out of the unissued

shares of the Preferred Stock for one or more series of Preferred Stock and to establish from time to time the number of shares to be included in each such series and to fix the voting rights, if any, designations, powers, preferences and relative, participating, optional, special and other rights, if any, of each such series and any qualifications, limitations and restrictions thereof, as shall be stated in the resolution or resolutions adopted by the Board providing for the issuance of such series and included in a certificate of designation (a “**Preferred Stock Designation**”) filed pursuant to the DGCL, and the Board is hereby expressly vested with the authority to the full extent provided by law, now or hereafter, to adopt any such resolution or resolutions.

#### Section 4.3 Common Stock Voting.

(i) Except as otherwise required by law or this Second Amended and Restated Certificate (including any Preferred Stock Designation), the holders of the shares of Common Stock shall exclusively possess all voting power with respect to the Corporation.

(ii) Except as otherwise required by law or this Second Amended and Restated Certificate (including any Preferred Stock Designation), the holders of shares of Common Stock shall be entitled to one vote for each such share on each matter properly submitted to the stockholders of the Corporation on which the holders of the shares of Common Stock are entitled to vote.

(iii) Except as otherwise required by law or this Second Amended and Restated Certificate (including any Preferred Stock Designation), at any annual or special meeting of the stockholders of the Corporation, the holders of the shares of Common Stock shall have the exclusive right to vote for the election of directors and on all other matters properly submitted to a vote of the stockholders of the Corporation. Notwithstanding the foregoing, except as otherwise required by law or this Second Amended and Restated Certificate (including any Preferred Stock Designation), the holders of the shares of Common Stock shall not be entitled to vote on any amendment to this Second Amended and Restated Certificate (including any amendment to any Preferred Stock Designation) that relates solely to the terms of one or more outstanding series of Preferred Stock if the holders of such affected series of Preferred Stock are entitled, either separately or together with the holders of one or more other such series, to vote thereon pursuant to this Second Amended and Restated Certificate (including any Preferred Stock Designation) or the DGCL.

(b) *Dividends*. Subject to applicable law, the rights, if any, of the holders of any outstanding series of the Preferred Stock, the holders of the shares of Common Stock shall be entitled to receive such dividends and other distributions (payable in cash, property or capital stock of the Corporation) when, as and if declared thereon by the Board from time to time out of any assets or funds of the Corporation legally available therefor and shall share equally on a per share basis in such dividends and distributions.

(c) *Liquidation, Dissolution or Winding Up of the Corporation*. Subject to applicable law, the rights, if any, of the holders of any outstanding series of the Preferred Stock, in the event of any voluntary or involuntary liquidation, dissolution or winding up of the Corporation, after payment or provision for payment of the debts and other liabilities of the Corporation, the holders of the shares of Common Stock shall be entitled to receive all the remaining assets of the Corporation available for distribution to its stockholders, ratably in proportion to the number of shares of Common Stock held by them.

Section 4.4 Rights and Options. The Corporation has the authority to create and issue rights, warrants and options entitling the holders thereof to acquire from the Corporation any shares of its capital stock of any class or classes, with such rights, warrants and options to be evidenced by or in instrument(s) approved by the Board. The Board is empowered to set the exercise price, duration, times for exercise and other terms and conditions of such rights, warrants or options; provided, however, that the consideration to be received for any shares of capital stock issuable upon exercise thereof may not be less than the par value thereof.

**ARTICLE V**  
**BOARD OF DIRECTORS**

Section 5.1 Board Powers. The business and affairs of the Corporation shall be managed by, or under the direction of, the Board. In addition to the powers and authority expressly conferred upon the Board by statute, this Second Amended and Restated Certificate or the Bylaws of the Corporation (as they may be amended from time to time, "*Bylaws*"), the Board is hereby empowered to exercise all such powers and do all such acts and things as may be exercised or done by the Corporation, subject, nevertheless, to the provisions of the DGCL, this Second Amended and Restated Certificate, and any Bylaws adopted by the stockholders of the Corporation; provided, however, that no Bylaws hereafter adopted by the stockholders of the Corporation shall invalidate any prior act of the Board that would have been valid if such Bylaws had not been adopted.

Section 5.2 Number, Election and Term.

(a) The number of directors of the Corporation, other than those who may be elected by the holders of one or more series of the Preferred Stock voting separately by class or series, shall be fixed from time to time exclusively by the Board pursuant to a resolution adopted by a majority of the Board.

(b) Subject to Section 5.5 hereof, the Board shall be divided into three classes, as nearly equal in number as possible and designated Class I, Class II, and Class III. The Board is authorized to assign members of the Board already in office to Class I, Class II, or Class III. The term of the initial Class I Directors shall expire at the first annual meeting of the stockholders of the Corporation following the effectiveness of this Second Amended and Restated Certificate, the term of the initial Class II Directors shall expire at the second annual meeting of the stockholders of the Corporation following the effectiveness of this Second Amended and Restated Certificate, and the term of the initial Class III directors shall expire at the third annual meeting of the stockholders following the effectiveness of this Second Amended and Restated Certificate. At each succeeding annual meeting of the stockholders of the Corporation, beginning with the first annual meeting of the stockholders of the Corporation following the effectiveness of this Second Amended and Restated Certificate, each of the successors elected to replace the class of directors whose term expires at that annual meeting shall be elected for a three year term or until the election and qualification of their respective successors in office, subject to their earlier death, resignation or removal. Subject to Section 5.5 hereof, if the number of directors that constitutes the Board is changed, any increase or decrease shall be apportioned by the Board among the classes so as to maintain the number of directors in each class as nearly equal as possible, but in no case shall a decrease in the number of directors constituting the Board shorten the term of any incumbent director. Subject to the rights of the holders of one or more series of Preferred Stock, voting separately by class or series, to elect directors pursuant to the terms of one or more series of Preferred Stock, the election of directors shall be determined by a plurality of the votes cast by the stockholders present in person or represented by proxy at the meeting and entitled to vote thereon. The Board is hereby expressly authorized, by resolution or resolutions thereof, to assign members of the Board already in office to the aforesaid classes at the time this Second Amended and Restated Certificate (and therefore such classification) becomes effective in accordance with the DGCL.

(c) Subject to Section 5.5 hereof, a director shall hold office until the next annual meeting for the year in which his or her term expires and until his or her successor has been elected and qualified, subject, however, to such director's earlier death, resignation, retirement, disqualification or removal.

(d) Unless and except to the extent that the Bylaws shall so require, the election of directors need not be by written ballot. The holders of shares of Common Stock shall not have cumulative voting rights.

Section 5.3 Newly Created Directorships and Vacancies. Subject to Section 5.5 hereof, newly created directorships resulting from an increase in the number of directors and any vacancies on the Board resulting from death, resignation, retirement, disqualification, removal or other cause may be filled solely and exclusively by a majority vote of the remaining directors then in office, even if less than a quorum, or by a sole remaining director (and not by stockholders), and any director so chosen shall hold office for the remainder of the full term of the

class of directors to which the new directorship was added or in which the vacancy occurred and until his or her successor has been elected and qualified, subject, however, to such director's earlier death, resignation, retirement, disqualification or removal.

Section 5.4 Removal. Subject to Section 5.5 hereof, any or all of the directors may be removed from office, but only for cause, by the affirmative vote of holders of a majority of the voting power of all then outstanding shares of capital stock of the Corporation entitled to vote generally in the election of directors, voting together as a single class, at a meeting called for that purpose.

Section 5.5 Preferred Stock—Directors. Notwithstanding any other provision of this Article V, and except as otherwise required by law, whenever the holders of one or more series of the Preferred Stock shall have the right, voting separately by class or series, to elect one or more directors, the term of office, the filling of vacancies, the removal from office and other features of such directorships shall be governed by the terms of such series of the Preferred Stock as set forth in this Second Amended and Restated Certificate (including any Preferred Stock Designation) and such directors shall not be included in any of the classes created pursuant to this Article V unless expressly provided by such terms.

## **ARTICLE VI BYLAWS**

In furtherance and not in limitation of the powers conferred upon it by law, the Board shall have the power and is expressly authorized to adopt, amend, alter or repeal the Bylaws by the affirmative vote of a majority of the total number of directors present at a regular or special meeting of the Board at which there is a quorum or by unanimous written consent. The Bylaws also may be adopted, amended, altered or repealed by the stockholders of the Corporation; provided, however, that in addition to any vote of the holders of any class or series of capital stock of the Corporation required by law or by this Second Amended and Restated Certificate (including any Preferred Stock Designation), the affirmative vote of the holders of at least a majority of the voting power of all then outstanding shares of capital stock of the Corporation entitled to vote generally in the election of directors, voting together as a single class, shall be required for the stockholders of the Corporation to adopt, amend, alter or repeal the Bylaws; and provided further, however, that no Bylaws hereafter adopted by the stockholders of the Corporation shall invalidate any prior act of the Board that would have been valid if such Bylaws had not been adopted.

## **ARTICLE VII SPECIAL MEETINGS OF STOCKHOLDERS; ACTION BY WRITTEN CONSENT**

Section 7.1 Special Meetings. Subject to the rights, if any, of the holders of any outstanding series of the Preferred Stock, and to the requirements of applicable law, special meetings of stockholders of the Corporation may be called only by the Chairman of the Board, Chief Executive Officer of the Corporation, or the Board pursuant to a resolution adopted by a majority of the Board, and the ability of the stockholders of the Corporation to call a special meeting is hereby specifically denied. Except as provided in the foregoing sentence, special meetings of stockholders of the Corporation may not be called by another person or persons.

Section 7.2 Advance Notice. Advance notice of stockholder nominations for the election of directors and of business to be brought by stockholders before any meeting of the stockholders of the Corporation shall be given in the manner provided in the Bylaws.

Section 7.3 Action by Written Consent. Except as may be otherwise provided for or fixed pursuant to this Second Amended and Restated Certificate (including any Preferred Stock Designation) relating to the rights of the holders of any outstanding series of Preferred Stock, any action required or permitted to be taken by the stockholders of the Corporation must be effected by a duly called annual or special meeting of such stockholders and may not be effected by written consent of the stockholders of the Corporation.

**ARTICLE VIII**  
**LIMITED LIABILITY; INDEMNIFICATION**

Section 8.1 Limitation of Director Liability. A director of the Corporation shall not be personally liable to the Corporation or its stockholders for monetary damages for breach of fiduciary duty as a director, except to the extent such exemption from liability or limitation thereof is not permitted under the DGCL as the same exists or may hereafter be amended unless a director violated his or her duty of loyalty to the Corporation or its stockholders, acted in bad faith, knowingly or intentionally violated the law, authorized unlawful payments of dividends, unlawful stock purchases or unlawful redemptions, or derived improper personal benefit from his or her actions as a director. Any amendment, modification or repeal of the foregoing sentence shall not adversely affect any right or protection of a director of the Corporation hereunder in respect of any act or omission occurring prior to the time of such amendment, modification or repeal.

Section 8.2 Indemnification and Advancement of Expenses.

(a) To the fullest extent permitted by applicable law, as the same exists or may hereafter be amended, the Corporation shall indemnify and hold harmless each person who is or was made a party to or is threatened to be made a party to or is otherwise involved in any threatened, pending or completed action, suit or proceeding, whether civil, criminal, administrative or investigative (a "***proceeding***") by reason of the fact that he or she is or was a director or officer of the Corporation or, while a director or officer of the Corporation, is or was serving at the request of the Corporation as a director, officer, employee or agent of another corporation or of a partnership, joint venture, trust, other enterprise or nonprofit entity, including service with respect to an employee benefit plan (an "***indemnitee***"), whether the basis of such proceeding is alleged action in an official capacity as a director, officer, employee or agent, or in any other capacity while serving as a director, officer, employee or agent, against all liability and loss suffered and expenses (including, without limitation, attorneys' fees, judgments, fines, ERISA excise taxes and penalties and amounts paid in settlement) reasonably incurred by such indemnitee in connection with such proceeding. The Corporation shall to the fullest extent not prohibited by applicable law pay the expenses (including attorneys' fees) incurred by an indemnitee in defending or otherwise participating in any proceeding in advance of its final disposition; provided, however, that, to the extent required by applicable law, such payment of expenses in advance of the final disposition of the proceeding shall be made only upon receipt of an undertaking, by or on behalf of the indemnitee, to repay all amounts so advanced if it shall ultimately be determined that the indemnitee is not entitled to be indemnified under this Section 8.2 or otherwise. The rights to indemnification and advancement of expenses conferred by this Section 8.2 shall be contract rights and such rights shall continue as to an indemnitee who has ceased to be a director, officer, employee or agent and shall inure to the benefit of his or her heirs, executors and administrators. Notwithstanding the foregoing provisions of this Section 8.2(a), except for proceedings to enforce rights to indemnification and advancement of expenses, the Corporation shall indemnify and advance expenses to an indemnitee in connection with a proceeding (or part thereof) initiated by such indemnitee only if such proceeding (or part thereof) was authorized by the Board.

(b) The rights to indemnification and advancement of expenses conferred on any indemnitee by this Section 8.2 shall not be exclusive of any other rights that any indemnitee may have or hereafter acquire under law, this Second Amended and Restated Certificate, the Bylaws, an agreement, vote of stockholders or disinterested directors, or otherwise.

(c) Any repeal or amendment of this Section 8.2 by the stockholders of the Corporation or by changes in law, or the adoption of any other provision of this Second Amended and Restated Certificate inconsistent with this Section 8.2, shall, unless otherwise required by law, be prospective only (except to the extent such amendment or change in law permits the Corporation to provide broader indemnification rights on a retroactive basis than permitted prior thereto), and shall not in any way diminish or adversely affect any right or protection existing at the time of such repeal or amendment or adoption of such inconsistent provision in respect of any proceeding (regardless of when such proceeding is first threatened, commenced or completed) arising out of, or related to, any act or omission occurring prior to such repeal or amendment or adoption of such inconsistent provision.

(d) This Section 8.2 shall not limit the right of the Corporation, to the extent and in the manner authorized or permitted by law, to indemnify and to advance expenses to persons other than indemnitees.

## ARTICLE IX CORPORATE OPPORTUNITY

### Section 9.1 Corporate Opportunities and Non-Employee Directors

(a) In recognition and anticipation that members of the Board who are not employees of the Corporation (the “*Non-Employee Directors*”) and their respective Affiliates may now engage and may continue to engage in the same or similar activities or related lines of business as those in which the Corporation, directly or indirectly, may engage and/or other business activities that overlap with or compete with those in which the Corporation, directly or indirectly, may engage, the provisions of this Article IX are set forth to regulate and define the conduct of certain affairs of the Corporation with respect to certain classes or categories of business opportunities as they may involve any of the Non-Employee Directors or their respective Affiliates and the powers, rights, duties and liabilities of the Corporation and its directors, officers and stockholders in connection therewith. For purposes of this Article IX, (i) “*Affiliate*” shall mean, (a) in respect of each Non-Employee Director, any Person that, directly or indirectly, is controlled by such Non-Employee Director (other than the Corporation and any entity that is controlled by the Corporation) and (b) in respect of the Corporation, any Person that, directly or indirectly, is controlled by the Corporation; and (ii) “*Person*” shall mean any individual, corporation, general or limited partnership, limited liability company, joint venture, trust, association or any other entity.

(b) No Non-Employee Director (including any Non-Employee Director who serves as an officer of the Corporation in both his or her director and officer capacities) or his or her Affiliates (such Persons being referred to, collectively, as “*Identified Persons*” and, individually, as an “*Identified Person*”) shall, to the fullest extent permitted by law, have any duty to refrain from directly or indirectly (1) engaging in the same or similar business activities or lines of business in which the Corporation or any of its Affiliates now engages or proposes to engage or (2) otherwise competing with the Corporation or any of its Affiliates, and, to the fullest extent permitted by law, no Identified Person shall be liable to the Corporation or its stockholders or to any Affiliate of the Corporation for breach of any fiduciary duty solely by reason of the fact that such Identified Person engages in any such activities. To the fullest extent permitted by law, the Corporation hereby renounces any interest or expectancy in, or right to be offered an opportunity to participate in, any business opportunity which may be a corporate opportunity for an Identified Person and the Corporation or any of its Affiliates, except as provided in Section 9.1(c) of this Article IX. Subject to said Section 9.1(c) of this Article IX, in the event that any Identified Person acquires knowledge of a potential transaction or other business opportunity which may be a corporate opportunity for itself, herself or himself and the Corporation or any of its Affiliates, such Identified Person shall, to the fullest extent permitted by law, have no duty to communicate or offer such transaction or other business opportunity to the Corporation or any of its Affiliates and, to the fullest extent permitted by law, shall not be liable to the Corporation or its stockholders or to any Affiliate of the Corporation for breach of any fiduciary duty as a stockholder, director or officer of the Corporation solely by reason of the fact that such Identified Person pursues or acquires such corporate opportunity for itself, herself or himself, or offers or directs such corporate opportunity to another Person.

(c) The Corporation does not renounce its interest in any corporate opportunity offered to any Non-Employee Director (including any Non-Employee Director who serves as an officer of this Corporation) if such opportunity is expressly offered to such person solely in his or her capacity as a director or officer of the Corporation, and the provisions of Section 9.1(b) of this Article IX shall not apply to any such corporate opportunity.

(d) In addition to and notwithstanding the foregoing provisions of this Article IX, a corporate opportunity shall not be deemed to be a potential corporate opportunity for the Corporation if it is a business opportunity that (i) the Corporation is unable, financially or legally, or is not contractually permitted to undertake, (ii) from its nature, is not in the line of the Corporation’s business or is of no practical advantage to the Corporation or (iii) is one in which the Corporation has no interest or reasonable expectancy.

(e) To the fullest extent permitted by law, any Person purchasing or otherwise acquiring any interest in any shares of capital stock of the Corporation shall be deemed to have notice of and to have consented to the provisions of this Article IX.

(f) Neither the alteration, amendment, addition to or repeal of this Article IX, nor the adoption of any provision of this Second Amended and Restated Certificate (including any Preferred Stock Designation) inconsistent with this Article IX, shall eliminate or reduce the effect of this Article IX in respect of any corporate opportunity first identified or any other matter occurring, or any cause of action, suit or claim that, but for this Article IX, would accrue or arise, prior to such alteration, amendment, addition, repeal or adoption.

#### **ARTICLE X AMENDMENT OF SECOND AMENDED AND RESTATED CERTIFICATE OF INCORPORATION**

The Corporation reserves the right at any time and from time to time to amend, alter, change or repeal any provision contained in this Second Amended and Restated Certificate (including any Preferred Stock Designation), and other provisions authorized by the laws of the State of Delaware at the time in force that may be added or inserted, in the manner now or hereafter prescribed by this Second Amended and Restated Certificate and the DGCL; and, except as set forth in Article VIII, all rights, preferences and privileges of whatever nature herein conferred upon stockholders, directors or any other persons by and pursuant to this Second Amended and Restated Certificate in its present form or as hereafter amended are granted subject to the right reserved in this Article X.

#### **ARTICLE XI EXCLUSIVE FORUM FOR CERTAIN LAWSUITS**

Section 11.1 Forum. Unless the Corporation consents in writing to the selection of an alternative forum, the Court of Chancery of the State of Delaware shall be the sole and exclusive forum for any stockholder (including a beneficial owner) to bring (i) any derivative action or proceeding brought on behalf of the Corporation, (ii) any action asserting a claim of breach of a fiduciary duty owed by any director, officer or other employee of the Corporation to the Corporation or the Corporation's stockholders, (iii) any action asserting a claim against the Corporation, its directors, officers or employees arising pursuant to any provision of the DGCL or this Second Amended and Restated Certificate or the Bylaws, or (iv) any action asserting a claim against the Corporation, its directors, officers or employees governed by the internal affairs doctrine and, if brought outside of Delaware, the stockholder bringing the suit will be deemed to have consented to service of process on such stockholder's counsel except any action (A) as to which the Court of Chancery in the State of Delaware determines that there is an indispensable party not subject to the jurisdiction of the Court of Chancery (and the indispensable party does not consent to the personal jurisdiction of the Court of Chancery within ten days following such determination), (B) which is vested in the exclusive jurisdiction of a court or forum other than the Court of Chancery, or (C) for which the Court of Chancery does not have subject matter jurisdiction. Notwithstanding the foregoing, the provisions of this Section 11.1 will not apply to suits brought to enforce any liability or duty created by the Exchange Act or any other claim for which the federal courts have exclusive jurisdiction. Notwithstanding the foregoing, the federal district courts of the United States of America, to the fullest extent permitted by law, shall be the sole and exclusive forum for the resolution of any action asserting a cause of action arising under the Securities Act. Any person or entity purchasing or otherwise acquiring any interest in any security of the Corporation shall be deemed to have notice of and consented to the provisions of this Section 11.1.

Section 11.2 Consent to Jurisdiction. If any action the subject matter of which is within the scope of Section 11.1 immediately above is filed in a court other than a court located within the State of Delaware (a "*Foreign Action*") in the name of any stockholder, such stockholder shall be deemed to have consented to (i) the personal jurisdiction of the state and federal courts located within the State of Delaware in connection with any action brought in any such court to enforce Section 11.1 immediately above (an "*FSC Enforcement Action*") and (ii) having service of process made upon such stockholder in any such FSC Enforcement Action by service upon such stockholder's counsel in the Foreign Action as agent for such stockholder.

**ARTICLE XII**  
**SEVERABILITY**

If any provision or provisions (or any part thereof) of this Second Amended and Restated Certificate shall be held to be invalid, illegal or unenforceable as applied to any person, entity or circumstance for any reason whatsoever, then, to the fullest extent permitted by law, (i) the validity, legality and enforceability of such provisions in any other circumstance and of the remaining provisions of this Second Amended and Restated Certificate (including, without limitation, each portion of any paragraph of this Second Amended and Restated Certificate containing any such provision held to be invalid, illegal or unenforceable that is not itself held to be invalid, illegal or unenforceable) and the application of such provision to other persons or entities and circumstances shall not in any way be affected or impaired thereby, and (ii) the provisions of this Second Amended and Restated Certificate (including, without limitation, each portion of any paragraph of this Second Amended and Restated Certificate containing any such provision held to be invalid, illegal or unenforceable) shall be construed so as to permit the Corporation to protect its directors, officers, employees and agents from personal liability in respect of their good faith service or for the benefit of the Corporation to the fullest extent permitted by law.

*[Signature page follows.]*



IN WITNESS WHEREOF, GigCapital5, Inc. has caused this Second Amended and Restated Certificate to be duly executed and acknowledged in its name and on its behalf by an authorized officer as of the date first set forth above.

GIGCAPITAL5, INC.

By: \_\_\_\_\_  
Name: Dr. Raluca Dinu  
Title: Chief Executive Officer, President and Secretary

*[Signature Page to Second Amended and Restated Certificate of Incorporation]*

**SCHEDULE 1.01**  
**Company Knowledge Parties**

Dr. John Klock - CEO  
Margaret Donigan - COO  
Ron LoVetri - Interim COO  
Mikel Ann Price - CFO  
Nasser Pirshfey - Chief Product Officer

**SCHEDULE 2.05**  
**Initial Post-Closing QTI Holdings Directors**

Sponsor Directors:

1. Dr. Avi S. Katz – Independent Director, Class III, Chairman of the QTI Holdings Board, Nominating and Corporate Governance Committee (Chair), Compensation Committee
2. Dr. Raluca Dinu – Independent Director, Class III, Compensation Committee (Chair), Audit Committee
3. Dotty Hayes – Independent Director, Class I, Audit Committee (Chair), Nominating and Corporate Governance Committee

Company Directors:

1. Dr. John Klock – Non-independent Director, Class III
2. Dan Dickson, Independent Director, Class II, Compensation Committee
3. Gerald McMorrow – Independent Director, Class I, Audit Committee
4. TBD – Independent Director, Class II, Nominating and Corporate Governance Committee

**SCHEDULE 7.03**  
**Key Company Stockholders**

John C. Klock, Jr. and Cynthia L. Klock Trust Dated 7/27/07  
Biotex Pharma Investments, LLC  
Biotex Pharma Investments II, LLC  
Kenneth G. Hungerford Trust  
B.D. Winston Family, Ltd.  
Richard J. and Barbara Stanley  
CVUS Ventures, LP  
Jachirijo Holdings LLC  
Mikel Ann Price  
Nasser Pirshafiey  
303 Development Corp.  
Margaret Donigan

## Stockholder Support Agreement

Execution Copy

STOCKHOLDER SUPPORT AGREEMENT, dated as of December 8, 2022 (this "Agreement"), by and among GigCapital5, Inc., a Delaware corporation ("GigCapital5"), and certain of the stockholders of QT Imaging, Inc., a Delaware corporation (the "Company"), whose names appear on the signature pages of this Agreement (each, a "Stockholder" and, collectively, the "Stockholders").

## RECITALS

**WHEREAS**, GigCapital5, QTI Merger Sub, Inc., a Delaware corporation and wholly owned subsidiary of GigCapital5 ("Merger Sub"), and the Company have negotiated a Business Combination Agreement in the form attached hereto as Exhibit B (the "BCA"; terms used but not defined in this Agreement shall have the meanings ascribed to them in the BCA), which provides, among other things, that, upon the terms and subject to the conditions thereof, Merger Sub will merge with and into the Company (the "Merger"), with the Company surviving the Merger as a wholly owned subsidiary of GigCapital5; and

**WHEREAS**, as of the date hereof, each Stockholder owns of record the number of shares of Company Common Stock and Company Preferred Stock as set forth opposite such Stockholder's name on Exhibit A hereto (all such shares of Company Common Stock and Company Preferred Stock and any shares of Company Common Stock and Company Preferred Stock of which ownership of record or the power to vote is hereafter acquired by the Stockholders prior to the termination of this Agreement being referred to herein as the "Shares").

## AGREEMENT

**NOW, THEREFORE**, in consideration of the foregoing and of the mutual covenants and agreements contained herein, and intending to be legally bound hereby, the parties hereto hereby agree as follows:

1. BCA Approved; Agreement to Vote. Each Stockholder, with respect to such Stockholder's Shares, severally and not jointly, hereby agrees to vote, at any meeting of the Stockholders of the Company, and in any action by written consent of the Stockholders of the Company (which written consent shall be delivered promptly, and in any event within forty eight (48) hours, after the Company requests such delivery), all of the Shares held by such Stockholder at such time in favor of the approval and adoption of the BCA and approval of the Merger and all other transactions contemplated by the BCA, provided in all cases that no changes have been made in the BCA or in the Merger or related transactions or ancillary agreements under the BCA that are material to one or more of the Stockholders. Provided no changes are made in the BCA or in the Merger or related transactions or ancillary agreements under the BCA that are material to one or more of the Stockholders, each Stockholder, severally and not jointly, hereby agrees to vote at any meeting of the Stockholders of the Company, and to act by written consent of Company Stockholders, against any action, agreement, transaction or proposal that would cause a material breach of any covenant, representation, warranty or other obligation or agreement of the Company under the BCA or that would reasonably be expected to prevent the Merger from being consummated. Each Stockholder acknowledges receipt and review of a copy of the BCA.

2. Termination of Stockholder Rights. Subject to consummation of the Closing pursuant to the BCA, each Stockholder, severally and not jointly, hereby agrees that, if applicable to such Stockholder, any rights under Article VII (*Transfer of Shares and Admission of New Stockholders*) and Article VIII (*Tag Along Rights*) of the Company's Bylaws, as amended, and any rights under any letter agreement providing for redemption rights, put rights, purchase rights or similar rights not generally available to Stockholders of the Company (the "Terminating Rights") between such Stockholder and the Company, shall terminate (and such Stockholder, without any further action, shall automatically and irrevocably release and waive any claim such Stockholder may have thereunder)

immediately prior to the Closing under the BCA, and prior thereto such Stockholder shall not exercise such rights in any manner inconsistent with the BCA or otherwise reasonably likely to interfere with, delay, impede, frustrate or prevent the consummation of the Merger. For the avoidance of doubt, the Terminating Rights shall exclude any rights such Stockholder may have that relate to any commercial or employment agreements or arrangements between such Stockholder and the Company or any subsidiary of the Company, which shall survive in accordance with their terms.

3. Transfer of Shares. Each Stockholder, severally and not jointly, agrees that he, she or it shall not, directly or indirectly, (a) sell, assign, transfer (including by operation of law), create any lien or pledge, dispose of or otherwise encumber any of the Shares or otherwise agree to do any of the foregoing, except for a sale, assignment or transfer pursuant to the BCA or to another Stockholder of the Company that is a party to this Agreement and bound by the terms and obligations hereof, (b) deposit any Shares into a voting trust or enter into a voting agreement or arrangement or grant any proxy or power of attorney with respect thereto that is inconsistent with this Agreement or (c) enter into any contract, option or other arrangement or undertaking with respect to the direct acquisition or sale, assignment, transfer or other disposition of any Shares, except as set forth in the BCA or this Agreement; provided, that the foregoing shall not prohibit the transfer of the Shares to an affiliate of Stockholder, but only if such affiliate of such Stockholder shall execute this Agreement or a joinder agreeing to become a party to this Agreement.

4. No Solicitation of Transactions. Each of the Stockholders, severally and not jointly, agrees not to directly or indirectly, through any officer, director, representative, agent or otherwise, (a) solicit, initiate or knowingly encourage (including by furnishing information) the submission of, or participate in any discussions or negotiations regarding, any transaction in violation of the BCA or (b) participate in any discussions or negotiations regarding, or furnish to any person or other entity or "group" within the meaning of Section 13(d) of the Exchange Act, any information with the intent to, or otherwise cooperate in any way with respect to, or knowingly assist, participate in, facilitate or encourage, any unsolicited proposal that constitutes, or may reasonably be expected to lead to, an Alternative Transaction in violation of the BCA. Each Stockholder shall, and shall direct his, her or its representatives and agents to, immediately cease and cause to be terminated any discussions or negotiations with any parties that may be ongoing with respect to any Alternative Transaction (other than the transactions contemplated by the BCA) to the extent required by the BCA. If any Stockholder receives any inquiry or proposal with respect to an Alternative Transaction, then such Stockholder shall promptly (and in no event later than twenty-four (24) hours after such Stockholder becomes aware of such inquiry or proposal) notify such person in writing that the Company is subject to an exclusivity agreement with respect to the sale of the Company that prohibits such Stockholder from considering such inquiry or proposal.

5. Representations and Warranties. Each Stockholder, severally and not jointly, represents and warrants to GigCapital5 as follows:

(a) The execution, delivery and performance by such Stockholder of this Agreement and the consummation by such Stockholder of the transactions contemplated hereby do not and will not (i) conflict with or violate any statute, law, ordinance, regulation, rule, code, executive order, injunction, judgment, decree or other order applicable to such Stockholder, (ii) require any consent, approval or authorization of, declaration, filing or registration with, or notice to, any person or entity, (iii) result in the creation of any encumbrance on any Shares (other than under this Agreement, the BCA and the agreements contemplated by the BCA) or (iv) if such Stockholder is an entity, conflict with or result in a breach of or constitute a default under any provision of such Stockholder's governing documents.

(b) As of the date of this Agreement, such Stockholder owns exclusively of record and has good and valid title to the Shares set forth opposite the Stockholder's name on Exhibit A free and clear of any security interest, lien, claim, pledge, proxy, option, right of first refusal, agreement, voting restriction, limitation on disposition, charge, adverse claim of ownership or use or other encumbrance of any kind and has the sole power to vote and the right, power and authority to sell, transfer and deliver such Shares, other than pursuant and subject to: (i) this Agreement, (ii) applicable securities laws, and (iii) the Company's certificate of incorporation

and bylaws. Such Stockholder is not the registered owner of any Shares other than those set forth on Exhibit A.

(c) Such Stockholder has the power, authority and capacity to execute, deliver and perform this Agreement and that this Agreement has been duly authorized, executed and delivered by such Stockholder. No person not a signatory to this Agreement (or such signatory's spouse for purposes of applicable community property laws) has a beneficial interest in or a right to acquire or vote any of the Shares (other than, if Stockholder is trust, the beneficiary(ies) thereof).

6. Termination. This Agreement and the obligations and liabilities of the Stockholders under this Agreement shall automatically terminate upon the earliest of (a) the Effective Time; (b) the termination of the BCA in accordance with its terms, (c) the effective date of a written agreement of the parties hereto terminating this Agreement and (d) any material breach by GigCapital5 of the BCA that is not fully cured within the time permitted by the BCA. Upon termination of this Agreement, neither party shall have any further obligations or liabilities under this Agreement. The representations and warranties contained in this Agreement and in any certificate or other writing delivered pursuant hereto shall not survive the Closing or the termination of this Agreement.

7. Miscellaneous.

(a) Except as otherwise provided herein, all costs and expenses incurred in connection with this Agreement and the transactions contemplated hereby shall be paid by the party incurring such costs and expenses, whether or not the transactions contemplated hereby are consummated.

(b) All notices, requests, claims, demands and other communications hereunder shall be in writing and shall be given (and shall be deemed to have been duly given upon receipt) by delivery in person, by e-mail or by registered or certified mail (postage prepaid, return receipt requested) to the respective parties at the following addresses or e-mail addresses (or at such other address or email address for a party as shall be specified in a notice given in accordance with this Section 7(b)):

If to GigCapital5, to:

GigCapital5, Inc.  
1731 Embarcadero Road, Suite 200  
Palo Alto, CA 94303  
Attention: Dr. Raluca Dinu, President and Chief Executive Officer  
Dr. Avi S. Katz, Executive Chairman of the Board  
Email: \*\*\*, \*\*\*

with a copy to:  
DLA Piper LLP (US)  
555 Mission Street  
Suite 2400  
San Francisco, CA 94105  
Attention: Jeffrey Selman; John Maselli  
Email: [jeffrey.selman@us.dlapiper.com](mailto:jeffrey.selman@us.dlapiper.com); [john.maselli@us.dlapiper.com](mailto:john.maselli@us.dlapiper.com)

If to a Stockholder, to the address or email address set forth for such Stockholder on the signature page hereof.

(c) If any term or other provision of this Agreement is invalid, illegal or incapable of being enforced by any rule of law, or public policy, all other conditions and provisions of this Agreement shall nevertheless remain in full force and effect so long as the economic or legal substance of the transactions contemplated hereby is not affected in any manner materially adverse to any party. Upon such determination that any term or other provision is invalid, illegal or incapable of being enforced, the parties hereto shall negotiate in good faith to modify this Agreement so as to effect the original intent of the parties as closely as possible in a mutually acceptable manner in order that the transactions contemplated hereby be consummated as originally contemplated to the fullest extent possible.

(d) This Agreement constitutes the entire agreement among the parties with respect to the subject matter hereof and supersedes all prior agreements and undertakings, both written and oral, among the parties, or any of them, with respect to the subject matter hereof. This Agreement shall not be assigned (whether pursuant to a merger, by operation of law or otherwise), by any party without the prior express written consent of the other parties hereto except as permitted by Section 4.

(e) This Agreement shall be binding upon and inure solely to the benefit of each party hereto, and nothing in this Agreement, express or implied, is intended to or shall confer upon any other person any right, benefit or remedy of any nature whatsoever under or by reason of this Agreement. No Stockholder shall be liable for the breach by any other Stockholder of this Agreement.

(f) The parties hereto agree that irreparable damage would occur in the event any provision of this Agreement was not performed in accordance with the terms hereof and that the parties shall be entitled to specific performance of the terms hereof in addition to any other remedy at law or in equity.

(g) This Agreement shall be governed by, and construed in accordance with, the laws of the State of Delaware applicable to contracts executed in and to be performed in that State. All Actions arising out of or relating to this Agreement shall be heard and determined exclusively in any Delaware Chancery Court. The parties hereto hereby (i) submit to the exclusive jurisdiction of the Delaware Chancery Court for the purpose of any Action arising out of or relating to this Agreement brought by any party hereto, and (ii) irrevocably waive, and agree not to assert by way of motion, defense, or otherwise, in any such Action, any claim that he, she or it is not subject personally to the jurisdiction of the above-named courts, that his, her or its property is exempt or immune from attachment or execution, that the Action is brought in an inconvenient forum, that the venue of the Action is improper, or that this Agreement or the transactions contemplated hereunder may not be enforced in or by any of the above-named courts.

(h) This Agreement may be executed and delivered (including by facsimile or portable document format (pdf) transmission) in counterparts, and by the different parties hereto in separate counterparts, each of which when executed shall be deemed to be an original but all of which taken together shall constitute one and the same agreement.

(i) At the request of GigCapital5, in the case of any Stockholder, or at the request of any Stockholder, in the case of GigCapital5, and without further consideration, each party shall execute and deliver or cause to be executed and delivered such additional documents and instruments and take such further action as may be reasonably necessary to implement the provisions of this Agreement.

(j) Notwithstanding anything to the contrary herein, this Agreement may be amended by adding additional Stockholders of the Company ("Additional Stockholders") as parties hereto, upon such Additional Stockholders executing and delivering to GigCapital5, a Joinder to the Stockholder Support Agreement substantially in the form of Exhibit C hereto. Thereafter, each such Additional Stockholder shall, for all purposes, be a party hereto and all references to a "Stockholder" or the "Stockholders" herein shall thereafter also mean and refer to such Additional Stockholder, and such Additional Stockholder shall thereafter have the same rights, duties, liabilities and obligations as a Stockholder party hereto on the date hereof.

(k) This Agreement shall not be effective or binding upon any Stockholder until after such time as the BCA is executed and delivered by the Company, GigCapital5 and Merger Sub.

(l) EACH OF THE PARTIES HERETO HEREBY WAIVES TO THE FULLEST EXTENT PERMITTED BY APPLICABLE LAW ANY RIGHT HE, SHE OR IT MAY HAVE TO A TRIAL BY JURY WITH RESPECT TO ANY LITIGATION DIRECTLY OR INDIRECTLY ARISING OUT OF, UNDER OR IN CONNECTION WITH THIS AGREEMENT. EACH OF THE PARTIES HERETO (I) CERTIFIES THAT NO REPRESENTATIVE, AGENT OR ATTORNEY OF ANY OTHER PARTY HAS REPRESENTED, EXPRESSLY OR OTHERWISE, THAT SUCH OTHER PARTY WOULD NOT, IN THE EVENT OF LITIGATION, SEEK TO ENFORCE THAT FOREGOING WAIVER AND (II) ACKNOWLEDGES THAT HE, SHE OR IT AND THE OTHER PARTIES HERETO HAVE BEEN INDUCED TO ENTER INTO THIS AGREEMENT AND THE TRANSACTIONS CONTEMPLATED HEREBY, AS APPLICABLE, BY, AMONG OTHER THINGS, THE MUTUAL WAIVERS AND CERTIFICATIONS IN THIS SECTION 6(K).

*[Signature Pages Follow]*



IN WITNESS WHEREOF, the parties have executed this Agreement as of the date first written above.

**GIGCAPITAL5, INC.**

By: /s/ Dr. Raluca Dinu

Name: Dr. Raluca Dinu

Title: President and Chief Executive Officer

*Signature page to Stockholder Support Agreement*

IN WITNESS WHEREOF, the parties have executed this Agreement as of the date first written above.

**JOHN C. KLOCK, JR. AND CYNTHIA L. KLOCK  
TRUST DATED 7/27/07**

By: /s/ John C. Klock

Name: John C. Klock

Title: Trustee

Address: \*\*\*  
\_\_\_\_\_

\_\_\_\_\_

\_\_\_\_\_

Email: \*\*\*  
\_\_\_\_\_

IN WITNESS WHEREOF, the parties have executed this Agreement as of the date first written above.

**BIOTEX PHARMA INVESTMENTS, LLC**

By: /s/ Robert Kessler

Name: Robert Kessler

Title: Manager

Address: \*\*\*

Email: \*\*\*

*Signature page to Stockholder Support Agreement*

IN WITNESS WHEREOF, the parties have executed this Agreement as of the date first written above.

**BIOTEX PHARMA INVESTMENTS II, LLC**

By: /s/ David Gentile

Name: David Gentile

Title: Manager

Address: \*\*\*

\_\_\_\_\_

\_\_\_\_\_

Email: \*\*\*

\_\_\_\_\_

*Signature page to Stockholder Support Agreement*

IN WITNESS WHEREOF, the parties have executed this Agreement as of the date first written above.

**KENNETH G. HUNGERFORD TRUST**

By: /s/ Kenneth G. Hungerford

Name: Kenneth G. Hungerford

Title: Trustee

Address: \*\*\*

Email: \*\*\*

*Signature page to Stockholder Support Agreement*

IN WITNESS WHEREOF, the parties have executed this Agreement as of the date first written above.

**B.D. WINSTON FAMILY, LTD.**

By: /s/ Benjamin D. Winston

Name: Benjamin D. Winston

Title: Managing Member of BD Winston Family  
Management, LLC (General Partner of  
B.D. Winston Family, LTD.)

Address: \*\*\*

\_\_\_\_\_  
\_\_\_\_\_  
\_\_\_\_\_

Email: \*\*\*

\_\_\_\_\_

IN WITNESS WHEREOF, the parties have executed this Agreement as of the date first written above.

**RICHARD J. AND BARBARA STANLEY**

By: /s/ Richard Stanley

Name: Richard Stanley

Title:

Address: \*\*\*

\_\_\_\_\_

\_\_\_\_\_

Email: \*\*\*

\_\_\_\_\_

*Signature page to Stockholder Support Agreement*

IN WITNESS WHEREOF, the parties have executed this Agreement as of the date first written above.

**CVUS VENTURES, LP**

By: /s/ David Gentile

Name: David Gentile

Title: General Partner

Address: \*\*\*

Email: \*\*\*

*Signature page to Stockholder Support Agreement*



IN WITNESS WHEREOF, the parties have executed this Agreement as of the date first written above.

**JACHIRJO HOLDINGS LLC**

By: /s/ David Gentile

Name: David Gentile

Title: Manager

Address: \*\*\*

Email: \*\*\*

*Signature page to Stockholder Support Agreement*

IN WITNESS WHEREOF, the parties have executed this Agreement as of the date first written above.

**MIKEL ANN PRICE**

By: /s/ Mikel Ann Price

Name: Mikel Ann Price

Title:

Address: \*\*\*

Email: \*\*\*

*Signature page to Stockholder Support Agreement*

IN WITNESS WHEREOF, the parties have executed this Agreement as of the date first written above.

**NASSER PIRSHAFIEY**

By: /s/ Nasser Charles Pirshafiey

Name: Nasser Charles Pirshafiey

Title: \_\_\_\_\_

Address: \*\*\* \_\_\_\_\_

\_\_\_\_\_

\_\_\_\_\_

Email: \*\*\* \_\_\_\_\_

*Signature page to Stockholder Support Agreement*

IN WITNESS WHEREOF, the parties have executed this Agreement as of the date first written above.

**303 DEVELOPMENT CORP.**

By: /s/ Richard Stanley

Name: Richard Stanley

Title: President

Address: \*\*\*

\_\_\_\_\_

\_\_\_\_\_

Email: \*\*\*

*Signature page to Stockholder Support Agreement*

IN WITNESS WHEREOF, the parties have executed this Agreement as of the date first written above.

**MARGARET DONIGAN**

By: /s/ Margaret Donigan

Name: Margaret Donigan

Title:

Address: \*\*\*

\_\_\_\_\_

\_\_\_\_\_

Email: \*\*\*

\_\_\_\_\_

**EXHIBIT A**

**Stockholders of Record – Number of Shares**

<b><u>Stockholder of Record</u></b>	<b><u>Number of Shares</u></b>
John C. Klock, Jr. and Cynthia L. Klock Trust Dated 7/27/07	***
Biotex Pharma Investments, LLC	***
Biotex Pharma Investments II, LLC	***
Kenneth G. Hunderford Trust	***
B.D. Winston Family, Ltd.	***
Richard J. and Barbara Stanley	***
CVUS Ventures, LP	***
Jachirijo Holdings LLC	***
Mikel Ann Price	***
Nasser Pirshafiey	***
303 Development Corp.	***
Margaret Donigan	***

---

**EXHIBIT B**

**Business Combination Agreement**

See Attached

*Exhibit B to Stockholder Support Agreement*

**EXHIBIT C**

**JOINDER TO STOCKHOLDER SUPPORT AGREEMENT**

This JOINDER TO STOCKHOLDER SUPPORT AGREEMENT (this “Joinder”) is made and entered into as of [●], by and among each of the stockholders of QT Imaging, Inc., a Delaware corporation (the “Company”), whose names appear on the signature pages of this Joinder (each, a “Stockholder” and, collectively, the “Stockholders”), and GigCapital5, Inc., a Delaware corporation (“GigCapital5”).

**RECITALS**

A. GigCapital5 and certain stockholders of the Company have entered into a Stockholder Support Agreement dated December 8, 2022 (as amended, modified, supplemented, extended or restated from time to time, the “Agreement”) in regard to the support of the Merger and the other transactions contemplated by the BCA. Capitalized terms used herein but not otherwise defined shall have the meanings set forth in the Agreement.

B. Pursuant to the Agreement, certain stockholders of the Company have agreed, among other things, to (i) vote in favor of the approval and adoption of the BCA and approval of the Merger and all other transactions contemplated by the BCA, and (ii) terminate the Terminating Rights effective immediately prior to the Closing under the BCA.

C. In order to induce GigCapital5 to consummate the Merger and other transactions contemplated by the BCA, [the] [each] Additional Stockholder is willing to become a party to the Agreement and be bound by all terms and conditions thereof.

NOW, THEREFORE, in consideration of the mutual covenants contained herein and other good and valuable consideration, the receipt and sufficiency of which are hereby acknowledged, the parties to this Joinder hereby agree as follows:

1. Agreement to be bound. [Each] [The] Additional Stockholder hereby: (a) acknowledges that he, she or it has received and reviewed a complete copy of the Agreement and understands its terms, (b) has had sufficient opportunity to review and to ask questions relating thereto and obtain the advice of his, her or its tax advisors, legal counsel and accountants and other professional advisors prior to executing this Agreement, and (c) agrees that upon execution of this Joinder, it shall become a “Stockholder” under the Agreement and shall be fully bound by, and subject to, all of the covenants, duties, obligations terms and conditions of the Agreement as though an original party thereto.

2. Governing Law. This Joinder and all acts and transactions pursuant hereto and the rights and obligations of the parties hereto shall be governed, construed and interpreted in accordance with the laws of the State of Delaware applicable to contracts executed in and to be performed in that State.

3. Counterparts. This Joinder may be executed in two or more counterparts, each of which shall be an original and all of which together shall constitute one instrument.

[REMAINDER OF THIS PAGE INTENTIONALLY LEFT BLANK]



IN WITNESS WHEREOF, the parties hereto have executed this Joinder to Stockholder Support Agreement as of the date first above written.

**[STOCKHOLDER NAME]**

By: \_\_\_\_\_

Name:

Title:

Address: \_\_\_\_\_

\_\_\_\_\_

\_\_\_\_\_

Email: \_\_\_\_\_

Securities beneficially owned on the date hereof:

\_\_\_\_\_ shares of Common Stock

IN WITNESS WHEREOF, the parties have executed this Joinder to Stockholder Support Agreement as of the date first written above.

**GIGCAPITAL5, INC.**

By: \_\_\_\_\_

Name: Dr. Raluca Dinu

Title: President and Chief Executive Officer

*Exhibit C to Stockholder Support Agreement*

**STOCKHOLDER SUPPORT AGREEMENT  
SPOUSAL CONSENT**

I \_\_\_\_\_, spouse of \_\_\_\_\_, have read and approve the foregoing Stockholder Support Agreement (the "**Agreement**"). In consideration of the terms and conditions as set forth in the Agreement, I hereby appoint my spouse as my attorney-in-fact with respect to the exercise of any rights and obligations under the Agreement, and agree to be bound by the provisions of the Agreement insofar as I may have any rights or obligations in the Agreement under the community property laws or similar laws relating to marital or community property in effect in the state of our residence as of the date of the Agreement.

Date \_\_\_\_\_

Signature of Spouse \_\_\_\_\_

Printed Name of Spouse \_\_\_\_\_

**SPONSOR SUPPORT AGREEMENT**

This SPONSOR SUPPORT AGREEMENT (this "Agreement"), dated as of December 6, 2022, is entered into by and among GigAcquisitions5, LLC, a Delaware limited liability company (the "Sponsor"), GigCapital5, Inc., a Delaware corporation ("GigCapital5"), and QT Imaging, Inc., a Delaware corporation (the "Company").

**RECITALS**

**WHEREAS**, concurrently herewith, the Company, QTI Merger Sub, Inc., a Delaware corporation ("Merger Sub"), and GigCapital5 are entering into a Business Combination Agreement (as amended, supplemented, restated or otherwise modified from time to time, the "BCA"), pursuant to which (and subject to the terms and conditions set forth therein) Merger Sub will merge with and into the Company (the "Merger"), with the Company surviving the Merger as a wholly owned subsidiary of GigCapital5;

**WHEREAS**, capitalized terms used but not otherwise defined in this Agreement shall have the meanings ascribed to them in the BCA;

**WHEREAS**, the Sponsor is currently the record owner of 6,530,000 shares of GigCapital5 Common Stock (the "Sponsor Shares"); and

**WHEREAS**, as a condition and inducement to the willingness of GigCapital5 and the Company to enter into the BCA, GigCapital5, the Company and the Sponsor are entering into this Agreement.

**AGREEMENT**

**NOW, THEREFORE**, in consideration of the foregoing and the mutual covenants and agreements set forth herein, and for other good and valuable consideration, the receipt and sufficiency of which are hereby acknowledged, and intending to be legally bound hereby, the Sponsor, GigCapital5 and the Company hereby agree as follows:

1.  Voting Agreement . The Sponsor agrees that, at the GigCapital5 Stockholders' Meeting, at any other meeting of the stockholders of GigCapital5 (whether annual or special and whether or not an adjourned or postponed meeting, however called and including any adjournment or postponement thereof) and in connection with any written consent of the stockholders of GigCapital5, the Sponsor shall:

a. when such meeting is held, appear at such meeting or otherwise cause the Sponsor Shares to be counted as present thereat for the purpose of establishing a quorum;

b. vote (or execute and return an action by written consent), or cause to be voted at such meeting (or validly execute and return and cause such consent to be granted with respect to), all of the Sponsor Shares (i) in favor of the approval and adoption of the BCA and approval of the Merger and all other transactions contemplated by the BCA and (ii) against any action, agreement or transaction or proposal that would result in a breach of any covenant, representation or warranty or any other obligation or agreement of GigCapital5 under the BCA or that would reasonably be expected to result in the failure of the Merger from being consummated and (iii) in favor of each of the proposals and any other matters necessary or reasonably requested by GigCapital5 for consummation of the Merger and the other transactions contemplated by the BCA; and

c. vote (or execute and return an action by written consent), or cause to be voted at such meeting (or validly execute and return and cause such consent to be granted with respect to), all of the Sponsor Shares against

(i) any Business Combination Proposal other than with the Company and (ii) any other action that would reasonably be expected to (x) materially impede, interfere with, delay, postpone or adversely affect the Merger or any of the other transactions contemplated by the BCA, or (y) result in a breach of any covenant, representation or warranty or other obligation or agreement of the Sponsor contained in this Agreement.

2. Transfer of Shares. Except as otherwise contemplated by the BCA or this Agreement, the Sponsor agrees that it shall not, directly or indirectly, (a) sell, assign, transfer (including by operation of law), create any lien or pledge, dispose of or otherwise encumber any of the Sponsor Shares or otherwise agree to do any of the foregoing, (b) deposit any Sponsor Shares into a voting trust or enter into a voting agreement or arrangement or grant any proxy or power of attorney with respect thereto that is inconsistent with this Agreement or (c) enter into any contract, option or other arrangement or undertaking requiring the direct acquisition or sale, assignment, transfer or other disposition of any Sponsor Shares. Without limiting the foregoing, and for the avoidance of doubt, the Sponsor agrees to comply, during the term of this Agreement, with the provisions of section 9 of that certain letter agreement, dated September 23, 2021, by and among GigCapital5, Sponsor, Wells Fargo Securities, LLC and William Blair & Company, L.L.C.

3. No Solicitation of Transactions. The Sponsor agrees not to directly or indirectly, through any officer, director, representative, agent or otherwise, (a) solicit, initiate or knowingly encourage (including by furnishing information) the submission of, or participate in any discussions or negotiations regarding, any transaction in violation of the BCA or (b) participate in any discussions or negotiations regarding, or furnish to any person or other entity or "group" within the meaning of Section 13(d) of the Exchange Act, any information with the intent to, or otherwise cooperate in any way with respect to, or knowingly assist, participate in, facilitate or encourage, any unsolicited proposal that constitutes, or may reasonably be expected to lead to, a Business Combination Proposal or other transaction in violation of the BCA. Sponsor shall, and shall cause its affiliates and Representatives to, immediately cease any and all existing discussions or negotiations with any person (other than with the Company, its stockholders and their respective affiliates and Representatives) conducted prior to the date hereof with respect to, or which is reasonably likely to give rise to or result in, a Business Combination Proposal. If the Sponsor receives any inquiry or proposal with respect to a Business Combination Proposal, then Sponsor shall promptly (and in no event later than twenty-four (24) hours after the Sponsor becomes aware of such inquiry or proposal) notify such person in writing that GigCapital5 is subject to an exclusivity agreement with respect to the Merger that prohibits Sponsor from considering such inquiry or proposal.

4. Representations and Warranties of the Sponsor. The Sponsor hereby represents and warrants to GigCapital5 and the Company as follows:

a. The Sponsor is the only record and a beneficial owner (within the meaning of Rule 13d-3 under the Exchange Act) of, and has good, valid and marketable title to, the Sponsor Shares, free and clear of Liens other than as created by this Agreement or Sponsor's organizational documents or the organizational documents of GigCapital5 (including, without limitation, for the purposes hereof, any agreement between or among stockholders of GigCapital5).

b. The Sponsor (i) has full voting power, full power of disposition and full power to issue instructions with respect to the matters set forth herein, in each case, with respect to the Sponsor Shares, (ii) has not entered into any voting agreement or voting trust with respect to any of the Sponsor Shares that is inconsistent with the Sponsor's obligations pursuant to this Agreement, (iii) has not granted a proxy or power of attorney with respect to any of the Sponsor Shares that is inconsistent with the Sponsor's obligations pursuant to this Agreement and (iv) has not entered into any agreement or undertaking that is otherwise inconsistent with, or would interfere with, or prohibit or prevent it from satisfying, its obligations pursuant to this Agreement.

c. The Sponsor (i) is a legal entity duly organized, validly existing and, to the extent such concept is applicable, in good standing under the Laws of the jurisdiction of its organization and (ii) has all requisite limited liability company or other power and authority and has taken all limited liability company or other action necessary in order to, execute, deliver and perform its obligations under this Agreement and to consummate the transactions contemplated hereby. This Agreement has been duly executed and delivered by the Sponsor and

constitutes a valid and binding agreement of the Sponsor enforceable against the Sponsor in accordance with its terms, subject to applicable bankruptcy, insolvency, fraudulent conveyance, reorganization, moratorium and similar Laws affecting creditors' rights generally and subject, as to enforceability, to general principles of equity.

d. Other than the filings, notices and reports pursuant to, in compliance with or required to be made under the Exchange Act, no filings, notices, reports, consents, registrations, approvals, permits, waivers, expirations of waiting periods or authorizations are required to be obtained by the Sponsor from, or to be given by the Sponsor to, or be made by the Sponsor with, any Governmental Authority in connection with the execution, delivery and performance by the Sponsor of this Agreement, the consummation of the transactions contemplated hereby or the Merger and the other transactions contemplated by the BCA.

e. The execution, delivery and performance of this Agreement by the Sponsor does not, and the consummation of the transactions contemplated hereby or the Merger and the other transactions contemplated by the BCA will not, constitute or result in (i) a breach or violation of, or a default under, the limited liability company agreement or similar governing documents of the Sponsor, (ii) with or without notice, lapse of time or both, a breach or violation of, a termination (or right of termination) of or a default under, the loss of any benefit under, the creation, modification or acceleration of any obligations under or the creation of a Lien on any of the properties, rights or assets of the Sponsor pursuant to any contract binding upon the Sponsor or, assuming (solely with respect to performance of this Agreement and the transactions contemplated hereby), compliance with the matters referred to in Section 1, under any applicable Law to which the Sponsor is subject or (iii) any change in the rights or obligations of any party under any contract legally binding upon the Sponsor, except, in the case of clause (ii) or (iii) directly above, for any such breach, violation, termination, default, creation, acceleration or change that would not, individually or in the aggregate, reasonably be expected to prevent or materially delay or impair the Sponsor's ability to perform its obligations hereunder or to consummate the transactions contemplated hereby, the consummation of the Merger or the other transactions contemplated by the BCA.

f. As of the date of this Agreement, there is no action, proceeding or investigation pending against the Sponsor or, to the knowledge of the Sponsor, threatened against the Sponsor that questions the beneficial or record ownership of the Sponsor Shares, the validity of this Agreement or the performance by the Sponsor of its obligations under this Agreement.

g. The Sponsor understands and acknowledges that each of GigCapital5 and the Company is entering into the BCA in reliance upon the Sponsor's execution and delivery of this Agreement and the representations, warranties, covenants and other agreements of the Sponsor contained herein

5. Further Assurances. From time to time, at either GigCapital5's or the Company's request and without further consideration, the Sponsor shall execute and deliver such additional documents and take all such further action as may be reasonably necessary or reasonably requested to effect the actions and consummate the transactions contemplated by this Agreement.

6. Changes in Capital Stock. In the event of a stock split, stock dividend or distribution, or any change in GigCapital5's capital stock by reason of any stock split, reverse stock split, recapitalization, combination, reclassification, exchange of shares or the like, equitable adjustment shall be made to the provisions of this Agreement as may be required so that the intended rights, privileges, duties and obligations hereunder shall be given full effect.

7. Amendment and Modification. This Agreement may not be amended, modified or supplemented in any manner, whether by course of conduct or otherwise, except by an instrument in writing signed by the Sponsor, GigCapital5 and the Company.

8. Waiver. No failure or delay by any party hereto exercising any right, power or privilege hereunder shall operate as a waiver thereof nor shall any single or partial exercise thereof preclude any other or further exercise thereof or the exercise of any other right, power or privilege. The rights and remedies of the parties hereto hereunder are cumulative and are not exclusive of any rights or remedies which they would otherwise have

hereunder. Any agreement on the part of a party hereto to any such waiver shall be valid only if set forth in a written instrument executed and delivered by such party.

9. Notices. All notices and other communications hereunder shall be in writing and shall be deemed given if delivered personally, by email (with confirmation of receipt) or sent by a nationally recognized overnight courier service to the parties hereto at the following addresses (or at such other address for a party as shall be specified by like notice made pursuant to this Section 9):

if to GigCapital5, to:

GigCapital5, Inc.  
1731 Embarcadero Road, Suite 200  
Palo Alto, CA 94303  
Attention: Dr. Raluca Dinu, President and Chief Executive Officer  
Dr. Avi S. Katz, Executive Chairman of the Board  
Email: \*\*\*, \*\*\*

with a copy to:

DLA Piper LLP (US)  
555 Mission Street  
Suite 2400  
San Francisco, CA 94105  
Attention: Jeffrey Selman; John Maselli  
Email: [jeffrey.selman@us.dlapiper.com](mailto:jeffrey.selman@us.dlapiper.com); [john.maselli@us.dlapiper.com](mailto:john.maselli@us.dlapiper.com)

if to the Sponsor, to:

GigAcquisitions5, LLC  
1731 Embarcadero Road, Suite 200  
Palo Alto, CA 94303  
Attention: Dr. Avi S. Katz, Manager  
Email: \*\*\*

if to the Company, to:

QT Imaging, Inc.  
3 Hamilton Landing, Suite 160  
Novato, California 94949  
Attention: Dr. John Klock, Chief Executive Officer  
Email: \*\*\*

with a copy to:

Seyfarth Shaw LLP  
975 F Street, NW  
Washington, DC 20004  
Attention: Andrew J. Sherman  
Email: [asherma@seyfarth.com](mailto:asherma@seyfarth.com)

10. Entire Agreement. This Agreement and the BCA constitute the entire agreement and supersede all prior agreements and understandings, both written and oral, among the parties hereto with respect to the subject matter hereof and thereof.

11. No Third-Party Beneficiaries. The Sponsor hereby agrees that its representations, warranties and covenants set forth herein are solely for the benefit of GigCapital5 and the Company in accordance with and subject to the terms of this Agreement, and this Agreement is not intended to, and does not, confer upon any person other than the parties hereto any rights or remedies hereunder, including, without limitation, the right to rely upon the representations and warranties set forth herein, and the parties hereto hereby further agree that this

Agreement may only be enforced against, and any action that may be based upon, arise out of or relate to this Agreement, or the negotiation, execution or performance of this Agreement may only be made against, the persons expressly named as parties hereto.

12. Governing Law; Venue; WAIVER OF JURY TRIAL.

a. This Agreement shall be governed by, interpreted under, and construed in accordance with the internal laws of the State of Delaware applicable to agreements made and to be performed within the State of Delaware, without giving effect to any choice-of-law provisions thereof that would compel the application of the substantive laws of any other jurisdiction.

b. All legal actions and proceedings arising out of or relating to this Agreement shall be heard and determined exclusively in any Delaware Chancery Court; *provided*, that if jurisdiction is not then available in the Delaware Chancery Court, then any such legal Action may be brought in any federal court located in the State of Delaware or any other Delaware state court. The parties hereto hereby (x) irrevocably submit to the exclusive jurisdiction of the aforesaid courts for themselves and with respect to their respective properties for the purpose of any Action arising out of or relating to this Agreement brought by any party hereto, and (y) agree not to commence any Action relating thereto except in the courts described above in Delaware, other than with respect to any appellate court thereof and other than Actions in any court of competent jurisdiction to enforce any judgment, decree or award rendered by any such court in Delaware as described herein. Each of the parties further agrees that notice as provided herein shall constitute sufficient service of process and the parties further waive any argument that such service is insufficient. Nothing in this Agreement will affect the right of any party to this Agreement to serve process in any other manner permitted by Law. Each of the parties irrevocably and unconditionally waives, and agrees not to assert, by way of motion or as a defense, counterclaim or otherwise, in any Action arising out of or relating to this Agreement or the transactions contemplated hereby, (i) any claim that it is not personally subject to the jurisdiction of the courts in Delaware as described herein for any reason, (ii) that it or its property is exempt or immune from jurisdiction of any such court or from any legal process commenced in such courts (whether through service of notice, attachment prior to judgment, attachment in aid of execution of judgment, execution of judgment or otherwise) and (iii) that (A) the Action in any such court is brought in an inconvenient forum, (B) the venue of such Action is improper or (C) this Agreement, or the subject matter hereof, may not be enforced in or by such courts.

c. EACH OF THE PARTIES HEREBY WAIVES TO THE FULLEST EXTENT PERMITTED BY APPLICABLE LAW ANY RIGHT IT MAY HAVE TO A TRIAL BY JURY WITH RESPECT TO ANY LITIGATION DIRECTLY OR INDIRECTLY ARISING OUT OF, UNDER OR IN CONNECTION WITH THIS AGREEMENT OR THE TRANSACTIONS CONTEMPLATED HEREBY. EACH OF THE PARTIES (I) CERTIFIES THAT NO REPRESENTATIVE, AGENT OR ATTORNEY OF ANY OTHER PARTY HAS REPRESENTED, EXPRESSLY OR OTHERWISE, THAT SUCH OTHER PARTY WOULD NOT, IN THE EVENT OF LITIGATION, SEEK TO ENFORCE THAT FOREGOING WAIVER AND (II) ACKNOWLEDGES THAT IT AND THE OTHERS HERETO HAVE BEEN INDUCED TO ENTER INTO THIS AGREEMENT BY, AMONG OTHER THINGS, THE MUTUAL WAIVERS AND CERTIFICATIONS IN THIS SECTION 12(C).

13. Assignment; Successors. Neither this Agreement nor any of the rights, interests or obligations hereunder shall be assigned by any of the parties hereto in whole or in part (whether by operation of Law or otherwise) without the prior written consent of the other party, and any such assignment without such consent shall be null and void. This Agreement shall be binding upon, inure to the benefit of and be enforceable by the parties hereto and their respective successors and permitted assigns.

14. Specific Performance. Each party acknowledges and agrees that the other parties hereto would be irreparably harmed and would not have any adequate remedy at law in the event that any of the provisions of this Agreement were not performed in accordance with their specific terms or were otherwise breached. Accordingly, each party agrees that the other parties hereto shall be entitled to an injunction or injunctions to prevent breaches of this Agreement and to enforce specifically the terms and provisions of this Agreement, this being in addition to any other remedy to which such parties are entitled at law or in equity.



15. Severability. In the event that any provision of this Agreement or the application thereof becomes or is declared by a court of competent jurisdiction to be illegal, void or unenforceable, the remainder of this Agreement will continue in full force and effect and the application of such provision to other persons or circumstances will be interpreted so as reasonably to effect the intent of the parties hereto.

16. Counterparts. This Agreement may be executed in one or more counterparts, all of which shall be considered one and the same agreement, it being understood that each party need not sign the same counterpart. This Agreement shall become effective when each party shall have received a counterpart hereof signed by all of the other parties. Signatures delivered electronically or by facsimile shall be deemed to be original signatures.

17. Termination. This Agreement shall terminate upon the earliest of (a) the Closing of the Merger, (b) the termination of the BCA in accordance with its terms, and (c) the time this Agreement is terminated upon the mutual written agreement of GigCapital5, the Company and the Sponsor.

*[Signature Pages Follow]*

IN WITNESS WHEREOF, the parties hereto have caused this Agreement to be executed (where applicable, by their respective officers or other authorized persons thereunto duly authorized) as of the date first written above.

**GIGCAPITAL5:**

**GIGCAPITAL5, INC.**

/s/ Dr. Raluca Dinu

By: Dr. Raluca Dinu, President and Chief Executive Officer

**SPONSOR:**

**GIGACQUISITIONS5, LLC**

/s/ Dr. Avi S. Katz

By: Dr. Avi S. Katz, Manager

*[Signature Page to Sponsor Support Agreement]*

IN WITNESS WHEREOF, the parties hereto have caused this Agreement to be executed (where applicable, by their respective officers or other authorized persons thereunto duly authorized) as of the date first written above.

**THE COMPANY:**

**QT IMAGING, INC.**

By: /s/ Dr. John Klock

Name: Dr. John Klock

Title: CEO and Chief Medical Officer

*[Signature Page to Sponsor Support Agreement]*



**QT Imaging and GigCapital5 Announce Signing of Business  
Combination Agreement to Bring Breast and Full Body Imaging  
Solutions to the Public Markets**

**PALO ALTO, CA. & NOVATO, CA, Dec. 12, 2022**—GigCapital5, Inc. (NYSE: GIA), a publicly traded special purpose acquisition company (“GigCapital5”), and QT Imaging, Inc. (“QT Imaging™”), a medical imaging company that develops novel products for body imaging, announced today that they have entered into a definitive business combination agreement that would result in QT Imaging becoming a publicly listed company subject to closing. Upon closing of the transaction, the combined company will be named QT Imaging Holdings, Inc. and will be traded on the NYSE under the new ticker symbol “QTI”. The goal is to complete the business combination in the first half of 2023.

Approximately 39 million women in the United States get mammograms every year (Source: CDC). For every 20 positive findings in mammograms, only one is actually cancer. Such a high callback rate leads to unnecessary, risky, painful, and expensive follow up medical procedures. QT Imaging exists to provide an improved imaging modality to address critical deficiencies in the current breast imaging paradigm. The FDA granted clearance for the QT ultrasound scanner, QTscan®, as an adjunct to mammography and the National Institute of Health (NIH) has awarded over \$15.5 million in funding for QT Imaging research.

Unlike traditional breast imaging modalities, the company’s QTscan does not require radiation, injection contrast agents, or compression, and is highly accurate and repeatable, allowing earlier and more frequent monitoring for women undergoing non-surgical breast cancer treatments such as adjuvant chemotherapy, radiation therapy, cryotherapy, and hormone or selective hormone receptor modulation treatments. No other ultrasound-based breast imaging modality is cleared by the FDA to quantify fibroglandular volume.

There is a great clinical need for a new body imaging modality that can be used for screening healthy people, infants, children, and pregnant women who are at risk when subjected to conventional whole body imaging systems, such as CT and MRI. There is also a great need for a low cost, comprehensive medical imaging modality that can be deployed in low resource environments. There are billions of people in the world who have no access to comprehensive medical imaging, a key medical tool that could dramatically improve medical care. QT Imaging’s technology offers the imaging modality for screening of healthy people, infants, and children at low costs.

QT Imaging, as a vertically integrated medical software – hardware imaging platform company in the business of designing and manufacturing ultra-low frequency transmitted sound imaging systems for breast and body imaging, is entering a commercial growth phase and plans to use the proceeds of the merger to seek to attain additional FDA approvals and further expand its commercial activities.

“QT Imaging’s core mission is to provide safe, highly accurate and inexpensive imaging systems to women and children,” said John Klock, MD, Founder and CEO of QT Imaging. “Healthcare’s high costs are in large part due to the high cost of medical imaging, and this needs to be addressed with safe, low-cost comprehensive imaging solutions.”

Dr. Avi Katz, Founding Managing Partner of GigCapital Global and Chairman of the board of directors of GigCapital5, commented: “It is a moral mission for the GigCapital5 team to partner with QT Imaging’s team to bring to the public markets their first breakthrough, FDA-cleared for breast imaging scanner, QTscan, as well as to support development and FDA clearances for imaging applications beyond the breast. GigCapital5 is our 5<sup>th</sup> SPAC and the GigCapital team is committed to working with exceptional teams of late stage, private companies to orchestrate the transition to the public markets and beyond in bettering the lives of the planet’s inhabitants, more so of minority and unprivileged communities. We are thrilled to be part of this exciting opportunity, improving, and extending the human life by reimagining the possibilities of imaging technology, bringing higher quality, safer, and lower cost medical imaging to all, and are humbled by the opportunity to partner with Dr. Klock and his team.”

#### **Transaction Overview**

The business combination values QT Imaging at an equity value of \$151 million. The combined company will receive approximately \$41 million in gross proceeds from GigCapital5’s trust account, assuming no redemptions by GigCapital5’s public stockholders, and up to \$26 million in additional financing to be raised prior to the closing of the business combination.

The transaction has been approved unanimously by the boards of directors of both QT Imaging and GigCapital5 and is currently expected to close in the first half of 2023, subject to regulatory and stockholder approvals, and other customary closing conditions.

Additional information about the proposed transaction, including a copy of the business combination agreement and investor presentation, will be provided on a Form 8-K to be filed by GigCapital5 with the Securities and Exchange Commission (“SEC”) and will be available on GigCapital5’s website at [www.gigcapital5.com](http://www.gigcapital5.com), QT Imaging’s website at [www.QTImaging.com](http://www.QTImaging.com), and at the SEC’s website at [www.sec.gov](http://www.sec.gov).

#### **Advisors**

Northland Securities, Inc. is serving as Financial and Capital Markets Advisors. DLA Piper LLP (US) is acting as legal counsel to GigCapital5. Seyfarth Shaw LLP is serving as legal counsel to QT Imaging.

#### **About QT Imaging, Inc.**

QT Imaging™ is engaged in the research, development, and commercialization of an innovative automated imaging system producing high-resolution transmission ultrasound images. The company has received FDA 510(K) clearance for its QT Imaging Breast Scanner. The company’s clinical trials have been conducted at prestigious institutions in the US and Europe, and the National Institutes of Health (NIH) has supported the development of the technology with over \$15 million in grants.

The QT Imaging Breast Scanner is indicated for use as an ultrasonic imaging system to provide reflection-mode and transmission-mode images of a patient's breast. The QT scanner software also calculates the breast fibroglandular volume and total breast volume. The device is not intended to be used as a replacement for screening mammography. (FDA 510k K162372 and K220933)

"QT Imaging" and "QTscan" are trademarks of QT Imaging, Inc.

#### **About GigCapital Global and GigCapital5, Inc.**

GigCapital Global ("GigCapital") is a Private-to-Public Equity (PPE)™ technology, media, and telecommunications (TMT) focused investment group led by an affiliated team of technology industry corporate executives and entrepreneurs, and TMT operational and strategic experts in the private and public markets, including substantial, success-proven M&A and IPO activities. The group deploys a unique Mentor-Investor™ methodology to partner with exceptional TMT companies, managed by dedicated and experienced entrepreneurs. The GigCapital Private-to-Public Equity (PPE) companies (also known as blank check companies or Special Purpose Acquisition Companies (SPACs)) offer financial, operational and executive mentoring to U.S. and overseas private, and non-U.S. public companies, in order to accelerate their path from inception and as a privately held entity into the growth-stage as a publicly traded company in the U.S. The partnership of GigCapital with these companies continues through an organic and roll-up strategy growth post the transition to a public company. GigCapital was launched in 2017 with the vision of becoming the lead franchise in incepting and developing TMT Private-to-Public Equity (PPE) companies. For more information, visit [www.gigcapitalglobal.com](http://www.gigcapitalglobal.com) or [www.GigCapital5.com](http://www.GigCapital5.com).

"Private-to-Public Equity (PPE)" and "Mentor-Investor" are trademarks of GigFounders, LLC, a member entity of GigCapital Global and the founder of GigAcquisitions5, LLC, used pursuant to agreement.

#### **Additional Information and Where to Find It**

This communication is being made in respect of the proposed business combination involving QT Imaging, GigCapital5 and GigCapital5's wholly-owned subsidiary, QTI Merger Sub, Inc. This communication does not constitute an offer to sell or the solicitation of an offer to buy any securities or a solicitation of any vote or approval, nor shall there be any sale of securities in any jurisdiction in which such offer, solicitation or sale would be unlawful prior to registration or qualification under the securities laws of such jurisdiction. In connection with the proposed transaction, (the "GigCapital5 proxy statement/prospectus") to be filed with the Securities and Exchange Commission (the "SEC") and mailed to GigCapital5's stockholders. GigCapital5 and QT urge investors and other interested persons to read, when available, the GigCapital5 proxy statement/prospectus, as well as other documents filed by GigCapital5 with the SEC, because these documents will contain important information about the proposed business combination. Such persons can also read GigCapital5's Annual Report on Form 10-K and Form 8-K reports for more information on the security holdings of its officers and directors and their respective interests as security holders in the consummation of the transactions described herein. The GigCapital5 proxy statement/prospectus, once available, and GigCapital5's other reports can be obtained, without charge, at the SEC's web site (<http://www.sec.gov>) and on GigCapital5's website at [www.gigcapital5.com](http://www.gigcapital5.com).

## Participants in the Solicitation

GigCapital5, QT Imaging, and their respective directors, executive officers and other members of their management and employees, under SEC rules, may be deemed to be participants in the solicitation of proxies of GigCapital5 stockholders in connection with the proposed business combination. Investors and security holders may obtain more detailed information regarding the names, affiliations and interests of GigCapital5's directors and officers in its Annual Report on Form 10-K for the fiscal year ended December 31, 2021, which was filed with the SEC on March 31, 2022. Information regarding the persons who may, under SEC rules, be deemed participants in the solicitation of proxies to GigCapital5's stockholders in connection with the proposed business combination will be set forth in the proxy statement/prospectus for the proposed business combination when available. Information concerning the interests of GigCapital5's and QT Imaging's equity holders and participants in the solicitation, which may, in some cases, be different than those of GigCapital5's and QT Imaging's equity holders generally, will be set forth in the GigCapital5 proxy statement/prospectus relating to the proposed business combination when it becomes available. GigCapital5 stockholders, potential investors and other interested persons should read the GigCapital5 proxy statement/prospectus carefully when it becomes available before making any voting or investment decisions.

## Forward Looking Statements

This press release includes "forward-looking statements" within the meaning of the "safe harbor" provisions of the Private Securities Litigation Reform Act of 1995. The expectations, estimates, and projections of the businesses of GigCapital5 and QT Imaging may differ from their actual results and consequently, you should not rely on these forward-looking statements as predictions of future events. Words such as "expect," "estimate," "project," "budget," "forecast," "anticipate," "intend," "plan," "may," "will," "could," "should," "believes," "predicts," "potential," "continue," and similar expressions are intended to identify such forward-looking statements. These forward-looking statements include, without limitation, expectations of the management of QT Imaging with respect to the business and prospects of QT Imaging and the QTscan and other products of QT Imaging, the benefits of the proposed business combination, the plans, expectations and intentions of QT Imaging and GigCapital5, the satisfaction of the closing conditions to the proposed business combination, the timing of the completion of the proposed business combination and the future performance of QT Imaging, including the anticipated impact of the proposed business combination on this performance. These forward-looking statements involve significant risks and uncertainties that could cause the actual results to differ materially from the expected results. Most of these factors are outside of the control of GigCapital5 and QT Imaging, and are difficult to predict. Factors that may cause such differences include, but are not limited to: (1) the ability of GigCapital5, QT Imaging and the surviving company to issue equity or equity-linked securities in connection with the proposed business combination or in the future, (2) the outcome of any legal proceedings that may be instituted against the parties following the announcement of the proposed business combination and the definitive agreements with respect thereto; (3) the inability to complete the proposed business combination, including the risk that any regulatory approvals or the SEC's declaration of the effectiveness of the GigCapital5 proxy statement/prospectus are not obtained, are delayed or are subject to unanticipated conditions that could adversely affect the surviving company or the expected benefits of the proposed business combination or due to failure to obtain approval of the stockholders of GigCapital5 and QT Imaging or other conditions to closing; (4) the amount of redemption requests made by GigCapital5's stockholders; (5) the impact of the COVID-19 pandemic on

(x) the parties' ability to consummate the proposed business combination and (y) the business of QT Imaging and the surviving company; (6) the receipt of an unsolicited offer from another party for an alternative business transaction that could interfere with the proposed business combination; (7) the inability to obtain or maintain the listing of the surviving company's common stock on the New York Stock Exchange or any other national stock exchange following the proposed business combination; (8) the risk that the proposed business combination disrupts current plans and operations as a result of the announcement and consummation of the proposed business combination; (9) the ability to recognize the anticipated benefits of the proposed business combination, which may be affected by, among other things, competition, the ability of the surviving company to grow and manage growth profitably and retain its key employees; (10) costs related to the proposed business combination; (11) changes in applicable laws or regulations; (12) the demand for QT Imaging's and the surviving company's services together with the possibility that QT Imaging or the surviving company may be adversely affected by other economic, business, and/or competitive factors; (13) risks and uncertainties related to QT Imaging's business, including, but not limited to, the ability of QT Imaging to increase sales of its output products in accordance with its plan; (14) risks related to the rollout of QT Imaging's business and the timing of expected business milestones; (15) the effects of competition on QT Imaging's business; (16) changes in domestic and foreign business, market, financial, political, and legal conditions; and (17) other risks and uncertainties included in (x) the "Risk Factors" sections of the most recent Annual Report on Form 10-K and Quarterly Reports on Form 10-Q filed with the SEC by GigCapital5 and (y) other documents filed or to be filed with the SEC by GigCapital5. The foregoing list of factors is not exclusive. You should not place undue reliance upon any forward-looking statements, which speak only as of the date made. GigCapital5 and QT Imaging do not undertake or accept any obligation or undertaking to release publicly any updates or revisions to any forward-looking statements to reflect any change in their expectations or any change in events, conditions, or circumstances on which any such statement is based.

#### **No Offer or Solicitation**

This press release shall not constitute a solicitation of a proxy, consent, or authorization with respect to any securities or in respect of the proposed business combination. This press release shall also not constitute an offer to sell or the solicitation of an offer to buy any securities, nor shall there be any sale of securities in any states or jurisdictions in which such offer, solicitation, or sale would be unlawful prior to registration or qualification under the securities laws of any such jurisdiction. No offering of securities shall be made except by means of a prospectus meeting the requirements of Section 10 of the Securities Act of 1933, as amended, or an exemption therefrom.

#### Contacts:

For QT Imaging, Inc.  
John Klock, MD  
[John.Klock@qtimaging.com](mailto:John.Klock@qtimaging.com)

For GigCapital5, Inc.  
Brian Ruby  
[brian.ruby@icrinc.com](mailto:brian.ruby@icrinc.com)





# ULTRALOW FREQUENCY TRANSMITTED SOUND IMAGING

---

December 2022

# Disclaimer

## About this Presentation

This investor presentation (this "**Presentation**") is provided for informational purposes only and has been prepared to assist interested parties in making their own evaluation with respect to the proposed business combination (the "**Proposed Business Combination**") between QT Imaging, Inc. ("**QT Imaging**") and GigCapital5, Inc. ("**GigCapital5**") and for no other purpose. The information contained herein does not purport to be all-inclusive or to contain all of the information that may be required to make a full analysis of QT Imaging or the Proposed Business Combination, and none of GigCapital5, QT Imaging, Northland Capital Markets, a division of Northland Securities, Inc. ("**Northland Capital Markets**"), or their respective directors, officers, employees, agents, advisors or affiliates makes any representation or warranty, express or implied, as to the accuracy, completeness or reliability of the information contained in this Presentation, which has not been verified and is subject to change at any time. Viewers of this Presentation should each make their own evaluation of QT Imaging, the Proposed Business Combination and of the relevance and accuracy of the information and should make such other investigations as they deem necessary. To the fullest extent permitted by law, no responsibility or liability whatsoever is accepted by GigCapital5, QT Imaging, Northland Capital Markets, or their respective directors, officers, employees, agents, advisors or affiliates for any loss howsoever arising, directly or indirectly, from any use of this Presentation or such information or opinions contained herein or otherwise arising in connection herewith.

This Presentation does not constitute (i) a solicitation of a proxy, consent or authorization with respect to any securities or in respect of the Proposed Business Combination or (ii) an offer to sell, a solicitation of an offer to buy, or a recommendation to purchase any security of GigCapital5, QT Imaging, or any of their respective affiliates, nor shall there be any sale, issuance or transfer of securities in any jurisdiction where, or to any person to whom, such offer, solicitation or sale would be unlawful. You should not construe the contents of this Presentation as legal, tax, accounting or investment advice or a recommendation. You should consult your own counsel and tax and financial advisors as to legal and related matters concerning the matters described herein, and, by accepting this Presentation, you confirm that you are not relying upon the information contained herein to make any decision. Any offer to sell securities will be made either (a) pursuant to a definitive subscription agreement (a "**Subscription Agreement**") for GigCapital5 and will be made in reliance on an exemption from registration under the Securities Act of 1933, as amended (the "**Securities Act**"), for offers and sales of securities that do not involve a public offering, or (b) with respect to the Proposed Business Combination, by means of a joint proxy statement/prospectus of GigCapital5 (the "**GigCapital5 proxy statement/prospectus**") that complies with applicable rules and regulations promulgated under the Securities Act and the Securities Exchange Act of 1934, as amended (the "**Exchange Act**"). GigCapital5, QT Imaging and their respective affiliates reserve the right to withdraw or amend for any reason any offering and to reject any Subscription Agreement for any reason. Any public offering of securities shall be made only by means of a prospectus meeting the requirements of the Securities Act.

## Disclaimer – Cont.

### Industry and Market Data

Industry and Market data used in this Presentation have been obtained from public sources and third-party industry publications. Such data has not been independently verified by QT Imaging or GigCapital5, and although such data is believed to be reliable, QT Imaging and GigCapital5 cannot assure its accuracy or completeness. The data is also subject to change. You are cautioned not to give undue weight to such industry and market data. Certain information contained in this Presentation relates to or is based on QT Imaging's own internal estimates and research. While QT Imaging believes its internal research is reliable, such research may not have been or has not been verified by any independent source and none of GigCapital5, QT Imaging or any of their respective affiliates nor any of its or their control persons, officers, directors, employees or representatives make any representation or warranty with respect to the accuracy of such research and information. This Presentation does not purport to be all inclusive or to contain all of the information that may be required to make a full analysis of QT Imaging, GigCapital5 or the Proposed Business Combination. Readers of this Presentation should make their own evaluation of QT Imaging, GigCapital5 and the Proposed Business Combination, and make such other investigations as they deem necessary.

### Forward Looking Statements

This Presentation includes "forward-looking statements" within the meaning of the "safe harbor" provisions of the Private Securities Litigation Reform Act of 1995. The expectations, estimates, and projections of the businesses of GigCapital5 and QT Imaging may differ from their actual results and consequently, you should not rely on these forward-looking statements as predictions of future events. Words such as "expect," "estimate," "project," "budget," "forecast," "anticipate," "intend," "plan," "may," "will," "could," "should," "believes," "predicts," "potential," "continue," and similar expressions are intended to identify such forward-looking statements. These forward-looking statements include, without limitation, expectations of the management of QT Imaging with respect to the business and prospects of QT Imaging and the QTscan® and other products of QT Imaging, the benefits of the Proposed Business Combination, the plans, expectations and intentions of QT Imaging and GigCapital5, the satisfaction of the closing conditions to the Proposed Business Combination, the timing of the completion of the Proposed Business Combination and the future performance of QT Imaging, including the anticipated impact of the Proposed Business Combination on this performance. These forward-looking statements are (i) based on various assumptions, whether or not identified in this Presentation, and on the current expectations of management of QT Imaging, (ii) not predictions of actual performance, (iii) provided for illustrative purposes only and (iv) not intended to serve as, and must not be relied on by any investor as, a guarantee, an assurance, a prediction or a definitive statement of fact or probability or any representation by any person that the forward-looking statements set forth in this Presentation or the results contemplated thereby will be achieved.

### Forward Looking Statements – Cont.

Actual events and circumstances are difficult or impossible to predict and will differ from assumptions. Many actual events and circumstances are beyond the control of the parties to the Proposed Business Combination and are difficult to predict. These forward-looking statements involve significant risks and uncertainties that could cause the actual results to differ materially from the expected results, including, but not limited to: (1) the ability of GigCapital5, QT Imaging and the surviving company to issue equity or equity-linked securities in connection with the Proposed Business Combination or in the future, (2) the outcome of any legal proceedings that may be instituted against the parties following the announcement of the Proposed Business Combination and the definitive agreements with respect thereto; (3) the inability to complete the Proposed Business Combination, including the risk that any regulatory approvals or the SEC's declaration of the effectiveness of the GigCapital5 proxy statement/prospectus are not obtained, are delayed or are subject to unanticipated conditions that could adversely affect the surviving company or the expected benefits of the Proposed Business Combination or due to failure to obtain approval of the stockholders of GigCapital5 and QT Imaging or other conditions to closing; (4) the amount of redemption requests made by GigCapital5's stockholders; (5) the impact of the COVID-19 pandemic on (x) the parties' ability to consummate the Proposed Business Combination and (y) the business of QT Imaging and the surviving company; (6) the receipt of an unsolicited offer from another party for an alternative business transaction that could interfere with the Proposed Business Combination; (7) the inability to obtain or maintain the listing of the surviving company's common stock on the New York Stock Exchange or any other national stock exchange following the Proposed Business Combination; (8) the risk that the Proposed Business Combination disrupts current plans and operations as a result of the announcement and consummation of the Proposed Business Combination; (9) the ability to recognize the anticipated benefits of the Proposed Business Combination, which may be affected by, among other things, competition, the ability of the surviving company to grow and manage growth profitably and retain its key employees; (10) costs related to the Proposed Business Combination; (11) changes in applicable laws or regulations; (12) the demand for QT Imaging's and the surviving company's services together with the possibility that QT Imaging or the surviving company may be adversely affected by other economic, business, and/or competitive factors; (13) risks and uncertainties related to QT Imaging's business, including, but not limited to, the ability of QT Imaging to increase sales of its output products in accordance with its plan; (14) risks related to the rollout of QT Imaging's business and the timing of expected business milestones; (15) the effects of competition on QT Imaging's business; (16) changes in domestic and foreign business, market, financial, political, and legal conditions; and (17) other risks and uncertainties included at the end of the Presentation or in (x) the "Risk Factors" sections of the most recent Annual Report on Form 10-K and Quarterly Reports on Form 10-Q filed with the SEC by GigCapital5 and (y) other documents filed or to be filed with the SEC by GigCapital5. The foregoing list of factors is not exclusive.

## Disclaimer – Cont.

### Forward Looking Statements – Cont.

If any of these risks, uncertainties or other factors materialize or QT Imaging's assumptions prove incorrect, actual results could differ materially from the results implied by these forward-looking statements. There may be additional risks that neither GigCapital5 nor QT Imaging presently know or that they currently believe are immaterial that could also cause actual results to differ from those contained in the forward-looking statements contained in this Presentation. In addition, forward looking statements in this Presentation speak only as of the date of this Presentation. While GigCapital5 and QT Imaging may elect to update these forward-looking statements at some point in the future GigCapital5 and QT Imaging do not undertake or accept any obligation or undertaking to release publicly any updates or revisions to any forward-looking statements to reflect any change in their expectations or any change in events, conditions, or circumstances on which any such statement is based and specifically disclaim any obligation to do so. These forward-looking statements should not be relied upon as representing GigCapital5's and QT Imaging's assessments as of any date subsequent to the date of this Presentation. Accordingly, undue reliance should not be placed upon these forward-looking statements. Information and opinions expressed in this Presentation were obtained from sources believed to be reliable and in good faith, and no representation or warranty, express or implied, is made as to the accuracy or completeness thereof. This Presentation contains preliminary information only, is subject to change at any time and is not, and should not be assumed to be, complete or constitute all the information necessary to adequately make an informed decision regarding your engagement with GigCapital5 or QT Imaging.

### Use Of Projections

This Presentation contains projected financial and operational information with respect to QT Imaging, which constitutes forward-looking information for illustrative purposes only. It should not be relied upon as indicative of future results. The assumptions and estimates underlying any financial forecast information are inherently uncertain and are subject to a wide variety of significant business, economic, competitive and other risks and uncertainties. See "Forward-Looking Statements" above. Actual results may differ materially from the results contemplated by the financial forecast information contained in this Presentation, and the inclusion of such information should not be regarded as a representation by any person that the results reflected in such forecasts will be achieved. QT Imaging has a limited operating history, has not generated significant revenues, has an unproven business model, and may face intense competition that makes it impossible to reliably predict future growth and operating results.

## Disclaimer – Cont.

### Trademark And Intellectual Property

QT Imaging and GigCapital5 own or have proprietary rights to various trademarks, service marks and trade names used in this Presentation that are important to their respective businesses, many of which are registered under applicable intellectual property laws. This Presentation also contains trademarks, trade names and service marks of other companies, which are the property of their respective owners. The use or display of third parties' trademarks, service marks, trade names or products in this Presentation is not intended to, and does not, imply a relationship with QT Imaging or GigCapital5, or an endorsement or sponsorship by or of QT Imaging or GigCapital5. Solely for convenience, trademarks, trade names and service marks referred to in this presentation may appear without the ®, ™ or SM symbols, but such references are not intended to indicate, in any way, that QT Imaging or GigCapital5 or any third party, as applicable, will not assert, to the fullest extent permitted under applicable law, its rights or the right of the applicable licensor to these trademarks, trade names and service marks.

### Participants in the Solicitation

GigCapital5, QT Imaging, and their respective directors, executive officers and other members of their management and employees, under SEC rules, may be deemed to be participants in the solicitation of proxies of GigCapital5 stockholders in connection with the Proposed Business Combination. Investors and security holders may obtain more detailed information regarding the names, affiliations and interests of GigCapital5's directors and officers in its Annual Report on Form 10-K for the fiscal year ended December 31, 2021, which was filed with the SEC on March 31, 2022 (the "**GigCapital5 Annual Report**"). Information regarding the persons who may, under SEC rules, be deemed participants in the solicitation of proxies to GigCapital5's stockholders in connection with the Proposed Business Combination will be set forth in the GigCapital5 proxy statement/prospectus for the Proposed Business Combination when available. Information concerning the interests of GigCapital5's and QT Imaging's equity holders and participants in the solicitation, which may, in some cases, be different than those of GigCapital5's and QT Imaging's equity holders generally, will be set forth in the GigCapital5 proxy statement/prospectus relating to the Proposed Business Combination when it becomes available. Stockholders, potential investors and other interested persons should read the proxy statement/prospectus carefully when it becomes available before making any voting or investment decisions. You may obtain free copies of these documents, once available, at the SEC's website at [www.sec.gov](http://www.sec.gov).

## Disclaimer – Cont.

### Additional Information and Where To Find It

In connection with the Proposed Business Combination, it is intended that GigCapital5 will prepare the GigCapital5 proxy statement/prospectus in a registration statement on Form S-4 (the “**Registration Statement**”) to be filed with the SEC. The Registration Statement will include a preliminary proxy statement, and following review by the SEC, a definitive proxy statement to be mailed to GigCapital5’s stockholders in connection with GigCapital5’s solicitation of proxies for the vote by GigCapital5’s stockholders with respect to the Proposed Business Combination and other matters described in the Registration Statement, and a prospectus relating to the offer of the securities to be issued by GigCapital5 in connection with the Proposed Business Combination. GigCapital5 and QT Imaging urge investors and other interested persons to read, when available, the Registration Statement, as well as other documents filed with the SEC, because these documents will contain important information about QT Imaging, GigCapital5 and the Proposed Business Combination. When available, the definitive GigCapital5 proxy statement/prospectus and other relevant materials for the Proposed Business Combination will be mailed to stockholders of GigCapital5 as of a record date to be established for voting on the Proposed Business Combination. Such persons can also read the GigCapital5 Annual Report for a description of the security holdings of GigCapital5’s officers and directors and their respective interests as security holders in the consummation of the transactions described herein. The Registration Statement, once available, and GigCapital5 Annual Report and Form 8-K can be obtained, without charge, at the SEC’s web site (<http://www.sec.gov>).

Investment in any securities described herein has not been approved or disapproved by the SEC or any other regulatory authority nor has any authority passed upon or endorsed the merits of the Proposed Business Combination or the accuracy or adequacy of the information contained herein. Any representation to the contrary is a criminal offense.

# Quantitative Transmission Ultrasound

AN EVOLUTION IN BREAST IMAGING





# Overview of GigCapital5, Inc.

- GigCapital5, Inc. (NYSE: GIA) is a \$41M publicly traded Special Purpose Acquisition Company (“SPAC”)
- GigCapital5’s IPO was completed in September 2021
- Led by a proven management team of experienced entrepreneurs and executives
  - Deep public company management and board experience
  - Extensive global network of TMT business professionals and investors
  - Proven experience of M&A, strategy, and technology

## Track Record of Successful SPAC Transactions<sup>(1)</sup>



<sup>(1)</sup> Market data as of December 12, 2022.

## GigCapital5 Leadership Team



**Dr. Avi Katz**  
EXECUTIVE CHAIRMAN

- Executive Chairman and Founding Managing Partner of GigCapital Global and all its entities, including GigCapital5
- COB of Kaleyra (NYSE: KLR), COB of UpHealth and Chair of Nom/Gov Committee (NYSE: UPH), BOD member BigBear (NYSE: BBAI) (Compensation Committee)
- Founder, COB, CEO GigOptix / GigPeak (NYSE: GIG)
- Serial entrepreneur and angel investor with 30+ years of experience in the technology sector



**Dr. Raluca Dinu**  
CEO, PRESIDENT & BOD MEMBER

- Board of Directors Member and Founding Managing Partner of GigCapital Global, CEO, President of GigCapital5
- BOD member of UpHealth (NYSE: UPH) (Compensation Committee, Compliance Committee Chair, Audit Committee), BOD member of BigBear (NYSE: BBAI) (Audit Committee)
- Previously General Manager / Vice President at Integrated Device Technology (IDT), acquired by Renesas Electronics Corp.
- COO of GigPeak, led the transfer and integration of the team from GigPeak into IDT post the acquisition of GigPeak by IDT in 2017



**Doty Hayes**  
BOD MEMBER

- BOD member of BigBear (NYSE: BBAI) (Audit Committee Chair) and Intevac (Nasdaq: IVAC) (Audit Committee Chair), BOD member of First Tech Credit Union
- Previously Chief Audit Executive at Hewlett-Packard, Corporate Controller/Chief Accounting Officer at Intuit, Agilent Technologies and Apollo Computer



# Built by a Veteran Healthcare Entrepreneur & Experienced Management

CEO & CHIEF  
MEDICAL  
OFFICER



**John Klock, MD**

Dr. Klock was involved in the founding of multiple disruptive medical companies, including BioMarin Pharmaceuticals (\$19B market cap) where he served as President. Dr. Klock has authored over 70 peer-reviewed medical and scientific publications and holds 8 granted patents.

CHIEF  
FINANCIAL  
OFFICER



**Mikie Price, CPA**

Ms. Price is a graduate of UCLA with a BS in Mathematics and a Specialization in Computing. Previously she worked for 2 ½ years at Ernst & Young in the audit practice in San Francisco where she obtained her CPA license (inactive). Ms. Price worked at Lucasfilm Ltd. in the Corporate Accounting group for 21 years where she was the Assistant Controller.

CHIEF  
PRODUCT  
OFFICER



**Nasser Pirshafiey, MBA**

Mr. Pirshafiey previously founded and managed a consulting firm providing sustainable practices to industries including medical devices, high-tech, and consumer products for giants such as Johnson & Johnson and Siemens. He has 16 inventions filed with the US patent office.

# Executive Summary

- Broad-based, no radiation medical imaging solution: **breast** • **infant body** • **orthopedics**
- FDA-cleared breast scanner with better sensitivity and specificity than mammography
- Patent-protected technology: **14 granted US/Europe** • **14 pending**
  - SW platform protected by trade secrets
- Worldwide distribution: **Asia** • **Europe** • **Middle East** • **North Africa**
- Experienced management with multiple successes
- Capital needs for additional FDA clearances, product development, clinical adoption, and commercialization



NIH awards QT  
Imaging over  
**\$15.5M**  
For new women's  
imaging solution

FDA grants  
**510(k)**  
clearance  
For the QT scanner



# Mission Statement

- Develop a safer, more accurate comprehensive imaging system
- Develop a safe body imaging technology for healthy persons and infants
- Develop a safe body imaging technology that can be point of care
- Increase the speed of medical imaging
- Lower the cost of medical imaging
- Improve medical outcomes globally by increasing access to medical imaging

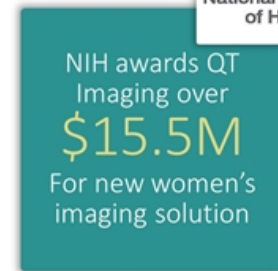

# NIH Grant History

YEAR	GRANT NUMBER	GRANT TITLE	INSTITUTION	AMOUNT
1976	1R01GM022549	Breast Tissue Characterization by Ultrasound	Mayo Clinic (Jim Greenleaf)	
1982-1989	1R01CA029728	Breast Cancer Detection using Ultrasound Tomography	University of Utah	\$760,855
1987	1R43CA045852	Model scanner validation for inverse scatter imaging	University of Utah	\$50,000
1994-1996	2R44CA045852	Scanner Validation for Inverse Scatter Breast Imaging	Techniscan Medical Inc	\$750,000
1995	1R01CA065713	3-D Inverse Scattering for Breast Cancer Detection	Techniscan Medical Inc	\$750,000
1997	1R43CA075828	New Software for ultrasound compression plate scanner	Techniscan Medical Inc	\$99,992
1998-2001	1R43CA077981	Ultrasound reflection tomographic breast scanner	Techniscan Medical Inc	\$848,088
1998-1999	1R43CA078018	Echo/Transmission Compression plate scanner	Techniscan Medical Inc	\$99,994
2004	1R43CA105916	Synergy of inverse scatter and vibroacoustics	Techniscan Medical Inc	\$99,997
2006	1R43CA121521	Breast Cancer Diagnosis: Ultrasound Quantitative Backscatter & Inverse Scattering	Techniscan Medical Inc	\$147,987
2006-2009	1R44CA110203	2-clinic feasibility study Inverse scatter breast scan	Techniscan Medical Inc	\$2,896,010
2007	1R43CA123915	Thermoacoustic and Inverse Scattering Breast Cancer Scanner	Techniscan Medical Inc	\$119,504
2009-2012	1R01CA138536	Partnership multi-modality quantitative ultrasound prototype breast cancer scanner	Techniscan Medical Inc	\$4,826,352
2012-2017	1R01CA138536	Multi-modality quantitative ultrasound breast cancer scanner	CVUS Clinical Trials LLC	\$3,750,000
2022-2027	1R01CA273700	Quantitative Ultrasound Monitoring of Breast Cancer Therapies	QT Imaging & Univ Illinois	\$3,100,000 (\$1.1M to QT)
<b>TOTAL</b>				<b>\$18.3M - \$15.5M to QT</b>

# Current and Future Platforms

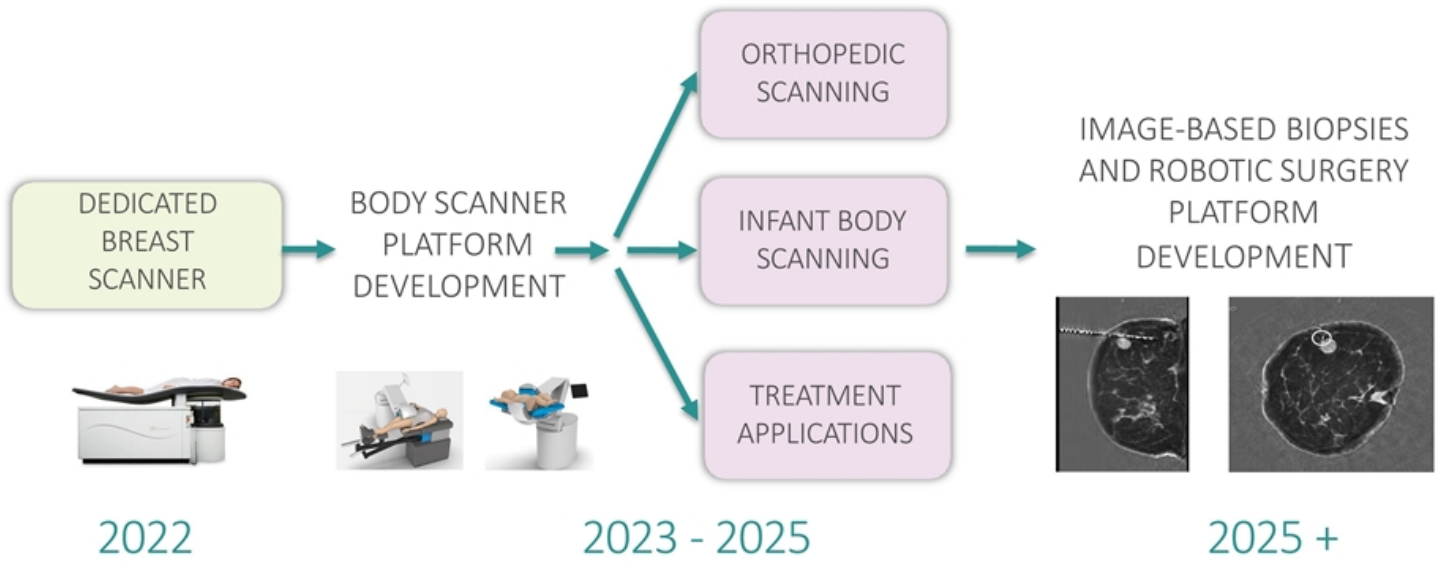

# QT'S Technology Has the Opportunity to Transform Several Large Markets

## 2022 GLOBAL MEDICAL IMAGING: \$29B MARKET<sup>(1)</sup>

CURRENT MARKET	FUTURE MARKET	FUTURE MARKET	FUTURE MARKET
<b>BREAST: \$5B MARKET<sup>(2)</sup></b>	<b>ORTHO: \$9B MARKET<sup>(3)</sup></b>	<b>INFANT: \$8 B MARKET<sup>(4)</sup></b>	<b>IMAGE-GUIDED PROCEDURES: \$5B MARKET<sup>(5)</sup></b>
<ul style="list-style-type: none"> <li>• QT initial area of focus</li> <li>• \$15.5M of grants from NIH, as current standard of care is inadequate</li> <li>• Goal to replace all or part of current imaging paradigm which includes mammography, ultrasound (handheld and automated), and MRI</li> </ul>	<ul style="list-style-type: none"> <li>• Under development</li> <li>• Target replacing MRI examinations</li> <li>• Primary focus on orthopedic practices</li> </ul>	<ul style="list-style-type: none"> <li>• Under development</li> <li>• New market opportunity given limitations of current imaging modalities for infants</li> </ul>	<ul style="list-style-type: none"> <li>• Commenced feasibility study</li> <li>• Variety of image-guided procedures including biopsies, injections and cryoablation</li> </ul>

<sup>(1)</sup> Medical Imaging Market Size, Share & Trends Analysis Report by Products (X-Ray, Ultrasound, Computed Tomography, Magnetic Resonance Imaging (MRI), Nuclear Imaging), by End Users (Hospitals, Diagnostic Imaging Centers, Other End Users), by Region (North America, Europe, Asia Pacific, Latin America, Middle East & Africa) - Global Industry Assessment (2016-2021) & Forecast (2022-2028), Vantage Market Research

<sup>(2)</sup> Coherent Market Insights

<sup>(3)</sup> Global Orthopedic Medical Imaging Systems Market Analysis Report 2022: Market to Reach \$10.6 Billion by 2026 - The US Corners Orthopedic Medical Imaging Market with Adoption of Innovative Systems, Research and Markets.

<sup>(4)</sup> Pediatric Imaging Market Size, Share & Trends Analysis Report by Modality (X-ray, Ultrasound, MRI, CT), by Application (Gastroenterology, Cardiology, Oncology), by End User, by Region, and Segment Forecasts, 2020 - 2027, Grandview Research.

<sup>(5)</sup> Image-guided Therapy Systems Market Size, Share & Trends Analysis Report by Product (Ultrasound Systems, Computed Tomography Scanners), by Application, by End-use, and Segment Forecasts, 2022 - 2030, Grandview Research.

# TECHNOLOGY OVERVIEW

QT imaging



# QT Has Introduced a New Imaging Modality

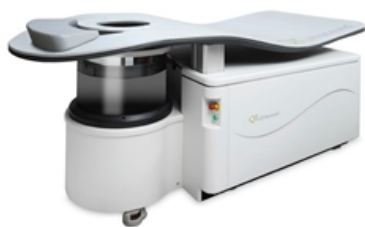

## SUPERIOR IMAGE QUALITY

High-fidelity, 3D sonographic images with exceptional resolution and accuracy



## SAFETY

Does not require ionizing radiation, magnetic fields, or contrast agent injections

## GOAL TO IMPROVE SCREENING AND DIAGNOSIS

**FDA clearance for breast imaging; breakthrough designation recognizes potential to screen high risk young women**



## IMPROVED PATIENT EXPERIENCE

Elimination of breast compression which could lead to improved compliance with screening guidelines (35% non-compliant)



## LOWER COST

The upfront and ongoing operating cost is significantly less than MRI or CT

# High Resolution, Quantitative Accuracy Requires 3D Model of Field Energy

The 3D nature of the transmitted acoustic field is seen here.

Transmitter

Hoffa's pad as a 'lens' in one view

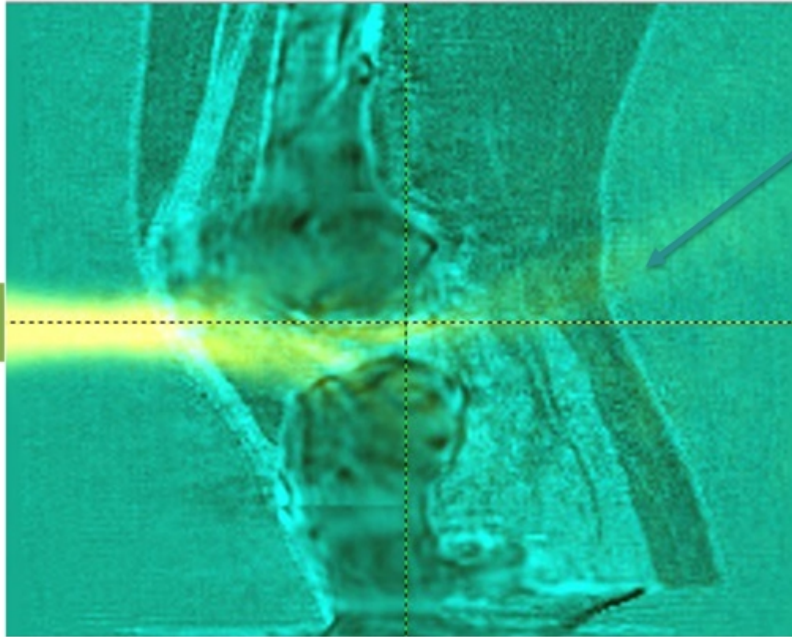

Acoustic energy through knee tibio-femoral space

Top view of acoustic field

Tx

Receiver

Rx

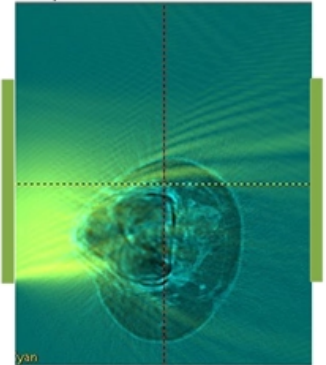

# Proprietary Transmission Ultrasound Design allows for 3D Image Reconstruction

## KEY SPECIFICATIONS

- Sound pressure plane wave 0.3 to 2 MHz
- Multi row vertical detector – 2,048 pixels
- Quantitative – acquisition in a 3D space
- Inverse scattering image reconstruction in 3D (not slice reconstruction)
- 150 trillion calculations per image

QT Imaging Plane Wave Transmitter

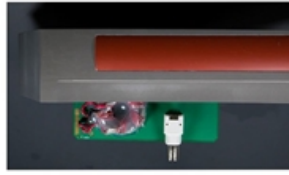

QT Imaging Multi-Array Detector



64 elements, 1.5x20mm  
0.3 MHz – 2.0 MHz (1.25 Center)

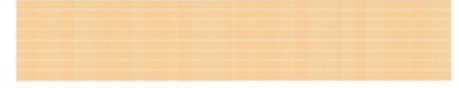

2048 elements, each 0.45x2.5mm  
0.3 MHz – 2.0 MHz

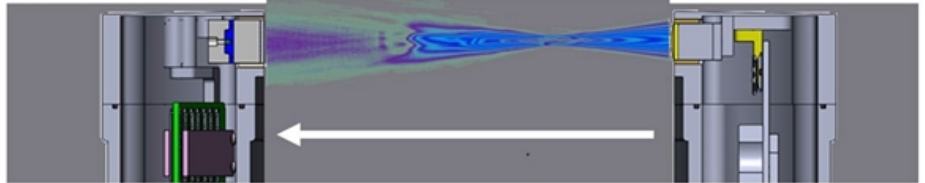

# How to Get These Images: 3D Ultrasound Volography

QT Imaging Scanner



Water bath

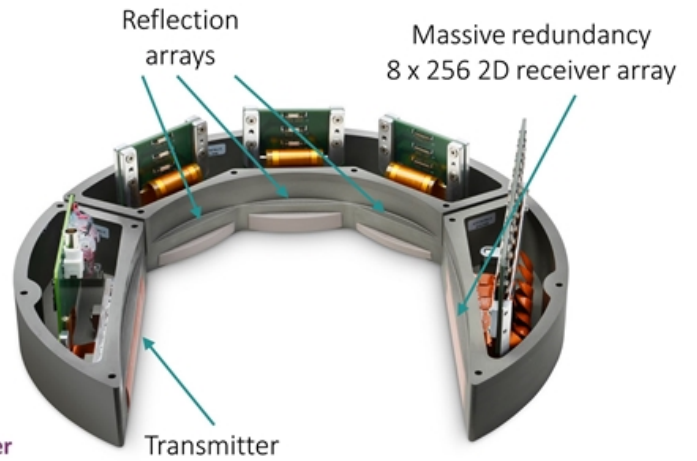

## Key Specs – Breast Scanner

- Laboratory Resolution
  - Reflective images: 0.9mm
  - Transmission images: 1.3mm
- Clinical Feature detection: below 11mm
- Only imaging modality that can see to the level of tissue histology

Copyright © 2022 QT Imaging, Inc. All Rights Reserved.

QT imaging

# The Ground Truth: QT Can See Down to the Level of Histology

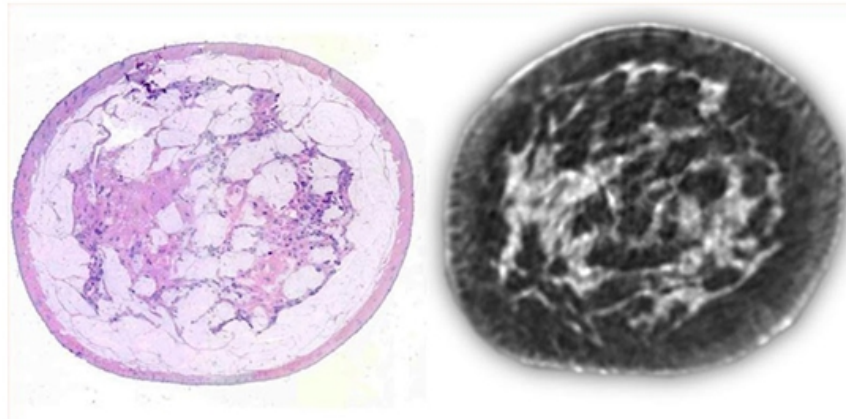

H&E Whole Breast Section

QT Speed Image

Source: John C. Klock, Elaine Iuanow, Bilal Malik, Nancy A. Obuchowski, James Wiskin, and Mark Lenox. Anatomy-Correlated Breast Imaging and Visual Grading Analysis Using Quantitative Transmission Ultrasound. *International Journal of Biomedical Imaging* Volume 2016, Article ID 7570406, 9 pages <http://dx.doi.org/10.1155/2016/7570406>

# Heavily Protected by Patents and Trade Secrets

## Patents and Trade Secrets

- QT uses a combination of patents and trade secrets to protect its technology
- Software IP is QT's most valuable asset and is protected by trade secrets
- 14 active US/EP patents with an additional 14 patents pending with the PTO
- The two primary patents that form QT's core technology are:
  - 7,684,846 (Apparatus and Method for Imaging Objects with Wavefields)
    - Describes the basic construction of QT's system, the rotary nature, and water bath construction
  - 8,246,543 (Imaging Method Utilizing Attenuation and Speed Parameters in Inverse Scattering Techniques)
    - Describes the mathematical methods and optimizations used to compute a 3D ultrasound image very quickly
- In addition to patent filings in the US, QT has also filed for patent protection in France, Germany, Italy, Spain, The Netherlands and the U.K.

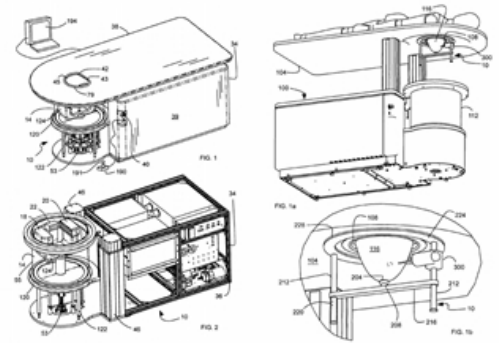

*Breast Scanning System  
(EP1610687)*

# BREAST HEALTH

QT imaging™

# QTscan Addresses Critical Deficiencies in Current Breast Imaging Paradigm

## SIGNIFICANT SHORTCOMING FOR WOMEN WITH DENSE BREASTS

- 50% of women in the US have dense breasts<sup>(1)</sup>

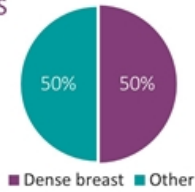

**MAMMOGRAPHY MISSES 35–50% OF BREAST CANCERS IN DENSE BREAST TISSUE<sup>(2)</sup>**

### SCREENING COMPLIANCE

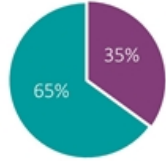

- 35% of women aged 40–70 do not get screened.<sup>(3)</sup>

- Do not follow guidelines
- Follow guidelines

(1)What it means to have dense breasts. Center for Disease Control and Prevention  
 (2)The Role of Ultrasound in Screening Dense Breasts. NCBI.  
 (3) Mammography. Center for Disease Control and Prevention

## FOR EVERY 1,000 SCREENING MAMMOGRAMS:

**RECALLS**  
 15% recalled for additional imaging – mammogram and/or ultrasound<sup>(4)</sup>



**98% OF RECALLS ARE AVOIDABLE**

**BIOPSIES**  
 ~10% biopsy rate for callbacks<sup>(5)</sup>



**OVER 80% OF CALLBACK BIOPSIES ARE BENIGN**

**CANCER INCIDENCE**  
 0.3% cancer diagnosis<sup>(6)</sup>



(4)False-negative rate of combined mammography and ultrasound for women with palpable breast masses. Breast Cancer Research and Treatment.

(5)Biopsy. National Breast Cancer Foundation, Inc.

(6)U.S. Breast Cancer Statistics. Breastcancer.org.



# Modality Comparisons: The QT Scan Provides Exceptional Image Quality

## IMAGES OF SAME BREAST USING FIVE IMAGING MODALITIES:

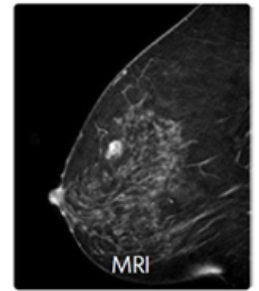
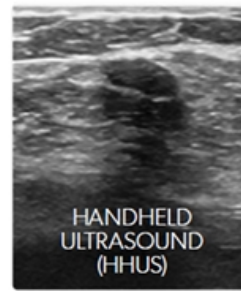
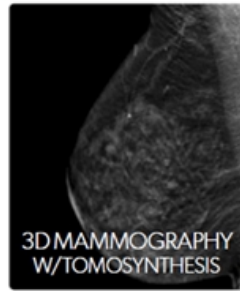
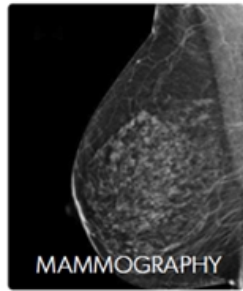
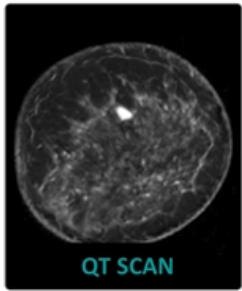

## The QT Imaging Advantage...

### ...OVER MAMMOGRAPHY

- Improved image quality
- Safer (no radiation), allowing for more frequent imaging
- Greater sensitivity and specificity
- Licensed technician not required
- No special facility requirements
- Quantifiable/repeatable

### ...OVER HHUS

- Superior image quality
- Not operator dependent
- Quantifiable/repeatable

### ...OVER MRI

- High resolution and contrast-to-noise ratio
- Faster, with no injection needed
- Lower equipment cost
- Licensed technician not required
- No special facility or shielding requirements

# Invasive Ductal Carcinoma Case 10

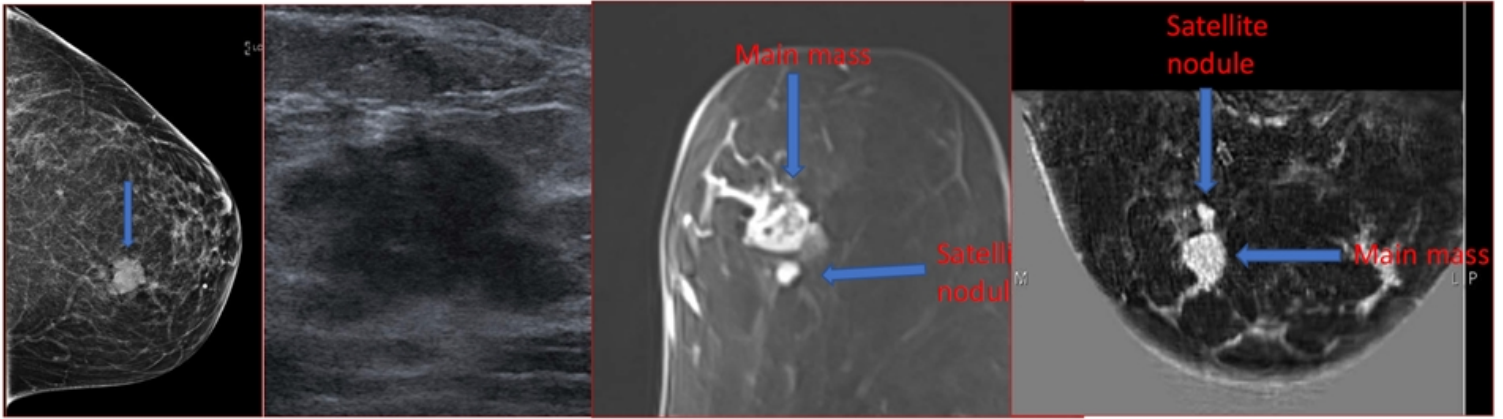

XRM

HHUS

MRI

QT Scan

# Higher Sensitivity and Specificity Than All Other Modalities

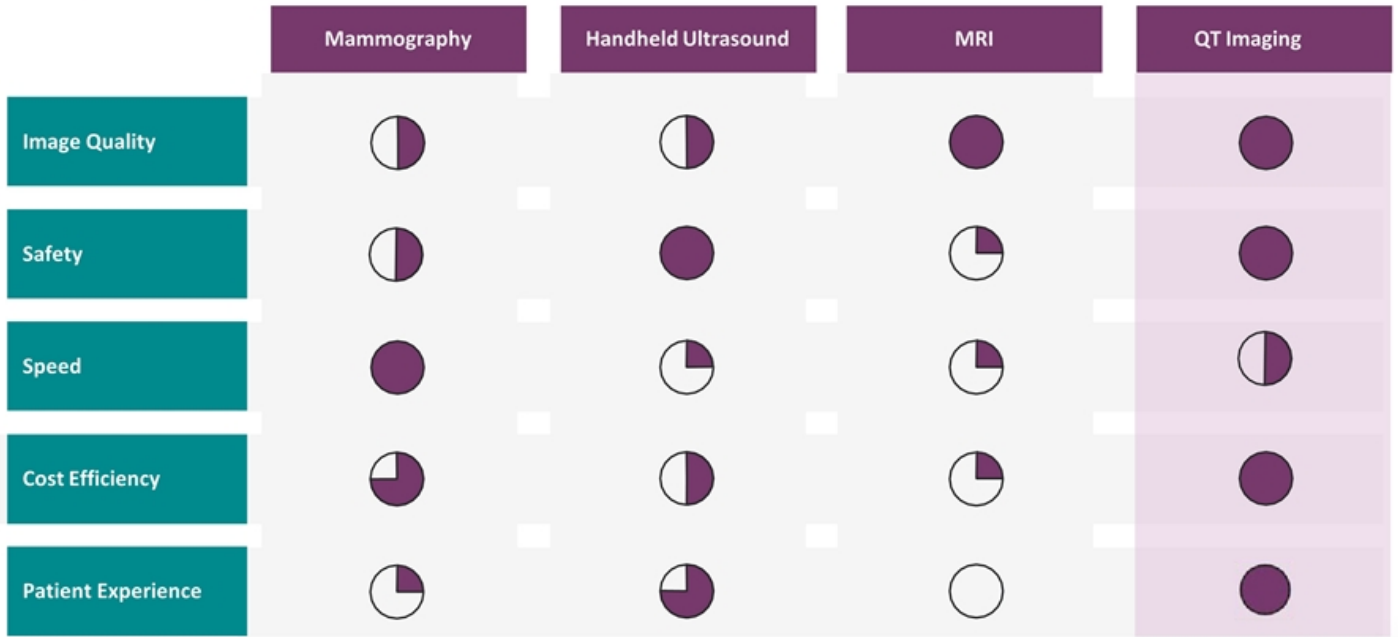

# QT Offers Only True 3D Data Capture and Image Reconstruction



**SIEMENS**

SonoCine

**HITACHI**

Delphinus  
Medical Technology

QT imaging

## Product

<b>Invenia ABUS</b> 	<b>Acuson S2000 ABVS</b> 	<b>AWBUS</b> 	<b>Sofia 3D</b> 	<b>Delphinus SoftVue</b> 	<b>QT Breast Scanner</b> 
--	---	---	---	---	---

## Design Type

Articulating Arm	Articulating Arm	Articulating Arm Guided Handheld	Rotating Armature	Water Bath	Water Bath
------------------	------------------	----------------------------------	-------------------	------------	------------

## Output

Stacked 2D Reflection Slices 	Stacked 2D Reflection Slices 	Stacked 2D Reflection Slices 	Stacked 2D Reflection Slices 	Stacked 2D Slices 	<b>Only Full 3D</b> 
---	---	---	--	--	--

Source: Manufacturer's websites.

Copyright © 2022 QT Imaging, Inc. All Rights Reserved.



# CLINICAL RESULTS

QT imaging™

# Clinical Trials – Dense Breast Imaging Study Confirmed DBT = 40% False-Negatives

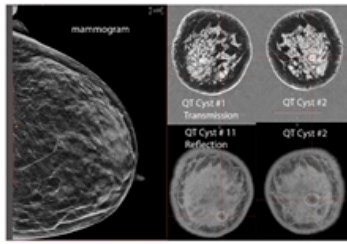

Cysts

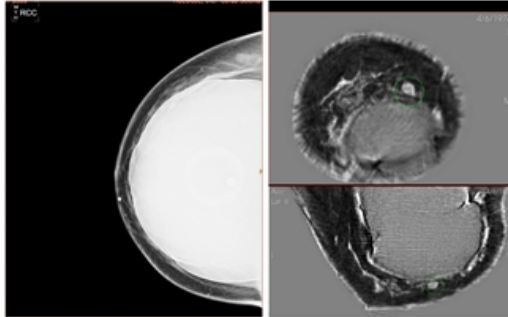
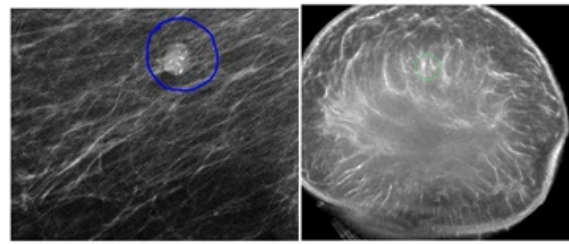

Implant with Mass

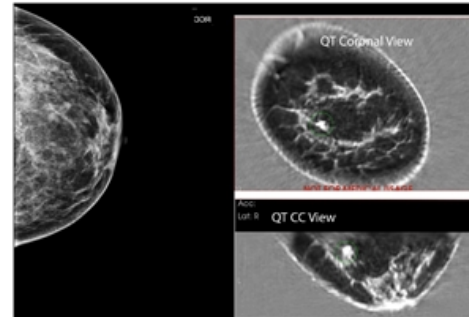

Cancer



vs



## QT was Non-inferior to Digital Breast Tomosynthesis in Mass Detection

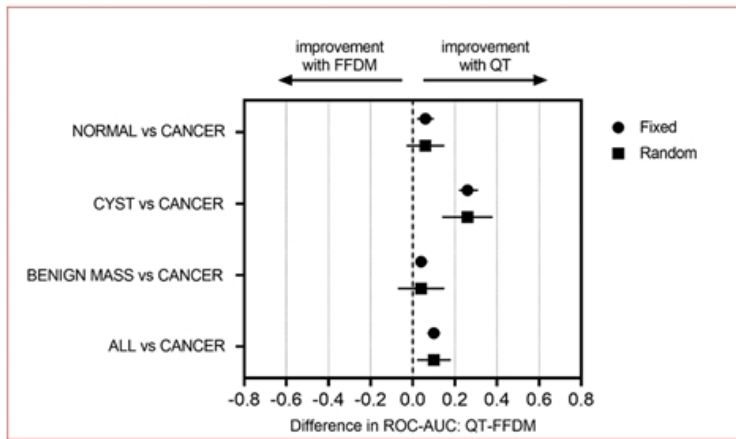

Study #1

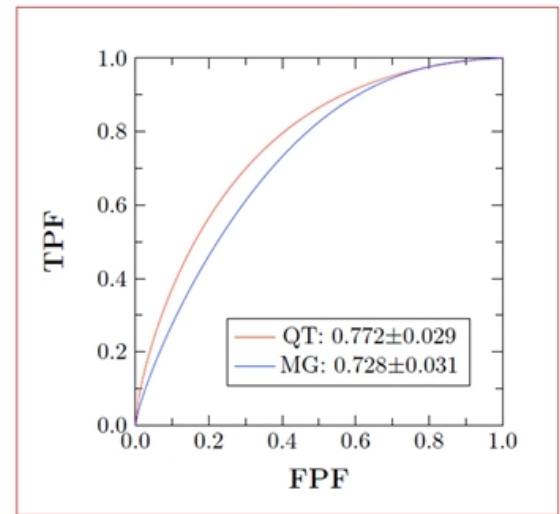

Study #2



VS



MRI

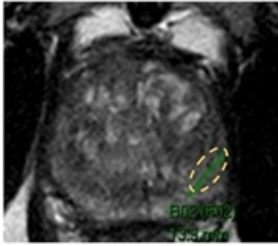

UT Reflection

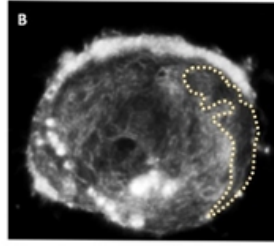

Wholemout Pathology

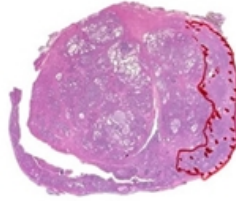

- QT had 86% sensitivity and 94% specificity
- 7T MRI had 65% sensitivity and 96% specificity

Axial MRI (A), acquired axial UT reflection sequence (B), acquired axial UT reflection sequence (C)

These results were reported at three scientific meetings:

- 
- [Medical Imaging, Feb. 2022](#)
-



# QT Imaging is an Nvidia Inception Partner

## NVIDIA A100 Tensor Core GPU

Unprecedented acceleration at every  
scale

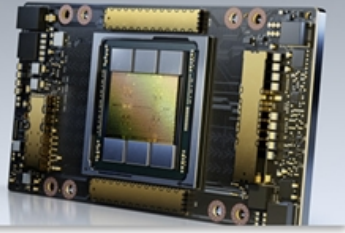

J. Wiskin and J. Klock, "3D Ultrasound tomography timing validation for clinical deployment," in 2022 IEEE International Ultrasonics Symposium (IUS), 2022, pp. 1-3.  
DOI: [10.1109/IUS54386.2022.9957317](https://doi.org/10.1109/IUS54386.2022.9957317)



Speed up factor for one (1) A100 vs Two (2) P6000s across  
several QT Imaging reconstruction 'protocols'

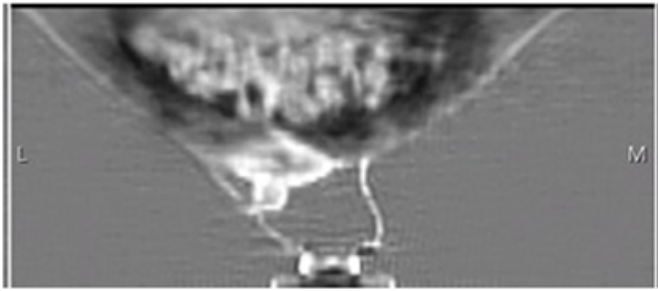

Normal

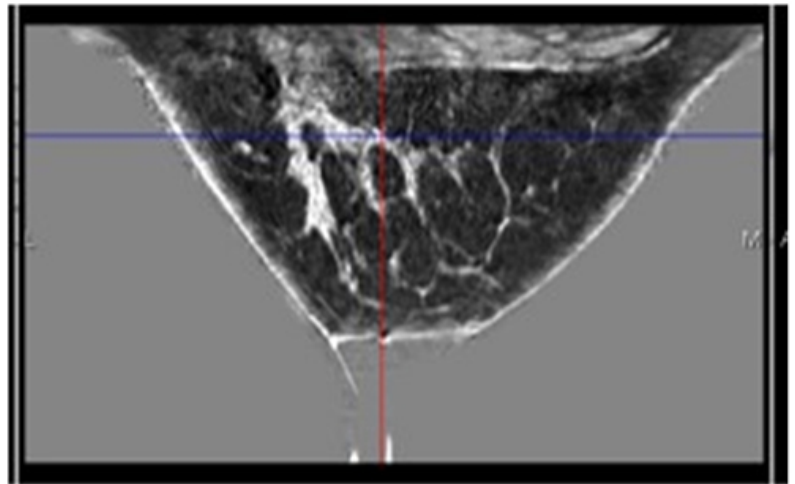

5 Degree Tilted Array

## Artifact Reduction Using Machine Learning

Normal

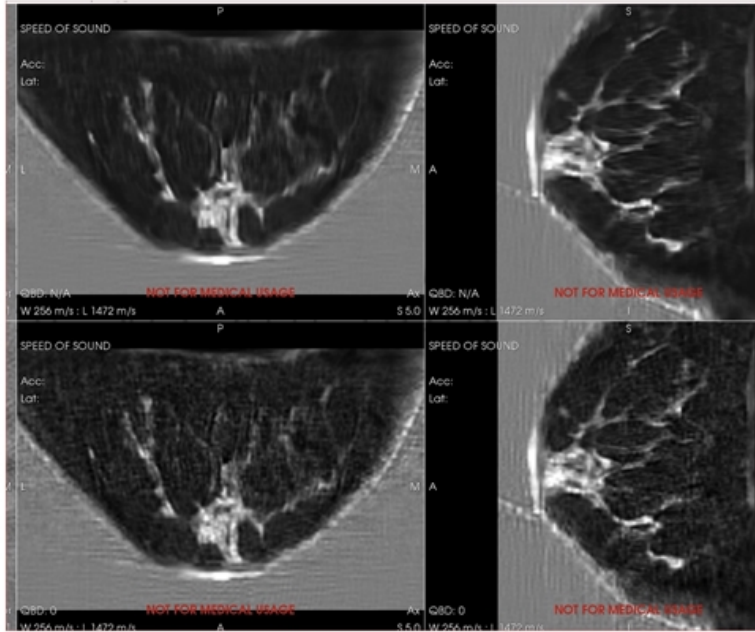

# REGULATORY STATUS

QT imaging

# Regulatory Clearances – December 2022 Update

INDICATION FOR USE	DESCRIPTION	FDA-CLEARED
BREAST IMAGING SOFTWARE IMPROVEMENTS	TRANSMISSION AND REFLECTION IMAGES OF THE BREAST RE-PROCESSING AND IMPROVED VIEWER	K162372 ISSUED (2017) K181785, K190626 (2018)
BREAKTHROUGH DESIGNATION		Q181785 (2019)
MEASURE FIBROGLANDULAR VOLUME (FGV)	ENABLES MONITORING OF HORMONE BLOCKER TREATMENTS IN WOMEN ENABLES MONITORING OF ADJUVANT CHEMOTHERAPY PRIOR TO SURGERY	K220933 (2022)

INDICATION FOR USE	DESCRIPTION	STATUS	NEXT STEPS
SCREENING YOUNG AT-RISK WOMEN	ALLOWS FOR PRIMARY SCREENING OF YOUNGER WOMEN WITH CANCER GENES OR STRONG FAMILY HISTORY	ALL DATA NEARLY COMPLETED	FDA SUBMISSION Q1 2023
CLINICAL TRIAL IN TORONTO CANADA	ALLOWS FOR SALE AND USE OF QT BREAST SCANNER BY INVESTIGATIONAL TESTING AUTHORITY	UNDER HEALTHCARE CANADA REVIEW	
SALE OUTSIDE U.S.	REQUIRED FOR PRODUCT REGISTRATION OF QT BREAST SCANNER IN COUNTRIES THAT USE US FDA CLEARANCE AS PREDICATE	ISO 13485 CERTIFICATION	PHASE II AUDIT IN Q1 2023

# FDA Breakthrough Device Designation for Screening

## FDA Grants QT Ultrasound® Breakthrough Device Designation

The FDA has designated the QT Ultrasound Breast Scanner as meeting an unmet medical need for screening women at high risk for breast cancer

- Fast-track 45-Day Review
- Preferred Standards for Clearance
- Guidance for Indications for Use
- CPT code fast track



QT Ultrasound Breast Scanner and Control Unit with QTviewer

“Quantitative Transmission Ultrasound is an emerging trend in ultrasound technology that can see through dense breasts and uses no radiation, giving it the potential to have significant benefits for younger women at high risk.”

# OPEN ANGLE SCANNER

QT imaging

# Open Angle Scanner

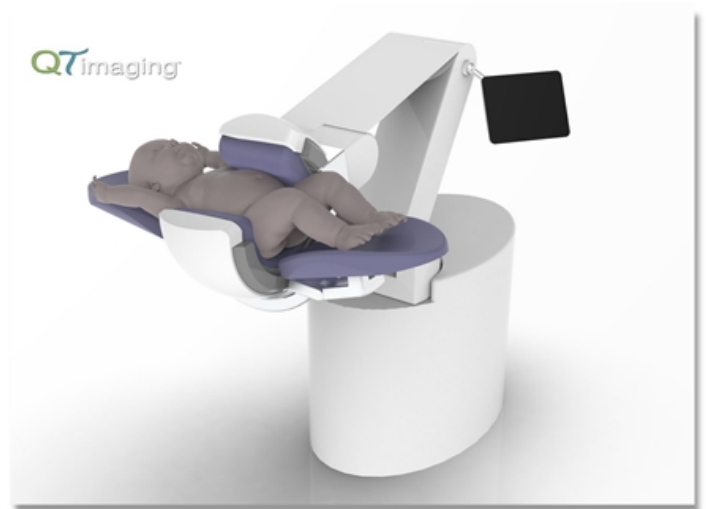
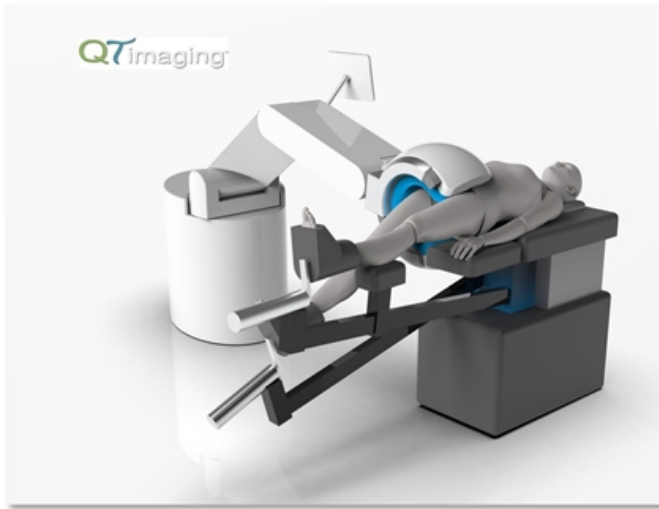



## FURTHER OPPORTUNITIES FOR MARKET ENTRY

- The Open Angle Scanner uses an open, partial angle configuration with the same platform technology as the QT Breast Scanner
- An open, partial angle configuration reduces the viewing field from 360 degrees to 325 degrees and provides additional capabilities for QT technology in:
  - Orthopedic imaging
  - Whole body infant scanning
  - Biopsy and image-guided diagnostic and treatment procedures
- Scanner satisfies the need for better image reconstruction techniques in partial-ring tomography systems, and offers a safe, comfortable, and affordable in-office imaging solution

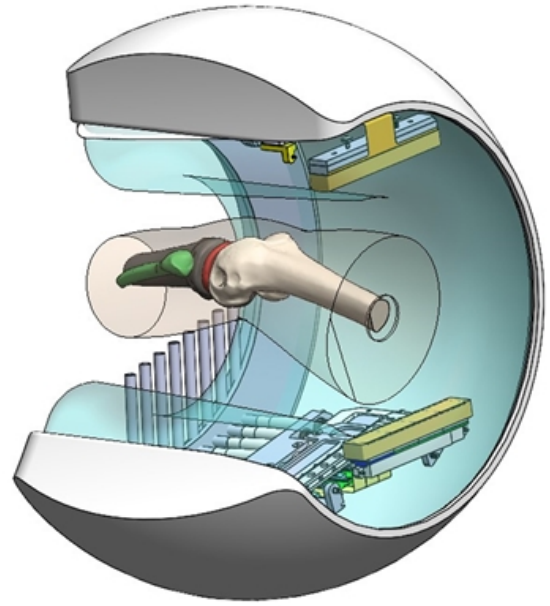

# Feasibility Studies Have Been Successfully Completed and the Development of the Open Angle Scanner Is Underway

## DEVELOPMENT STAGE

- QT has successfully completed feasibility studies for partial angle reconstruction
- QT has verified the ability to perform data acquisition and image reconstruction with a membrane within the field
- Currently doing conceptual work to design a device platform to accommodate orthopedic and infant imaging

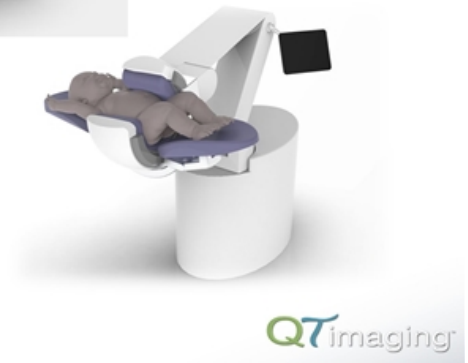
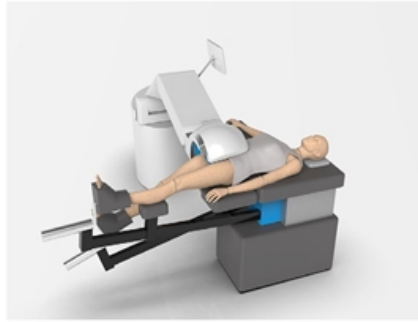

**scientific reports**

[Check for updates](#)

**OPEN** **Full wave 3D inverse scattering transmission ultrasound tomography in the presence of high contrast**

James Wiskin<sup>1</sup>, Bilal Malik, David Borup, Nasser Pirshafiey & John Klock

QT ultrasound LLC, Novato, USA. <sup>✉</sup>email: james.wislin@qtultrasound.com

---

Scientific Reports | (2020) 10:20666 | <https://doi.org/10.1030/s41598-020-76754-3> **nature** research 1

# QT vs MRI: Human Knee

QT Scan

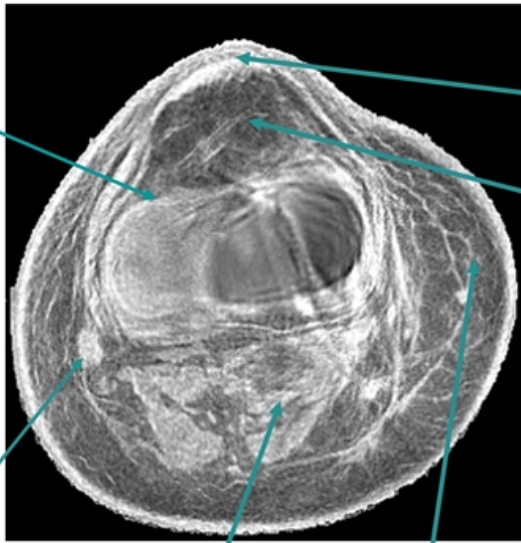

Articular cartilage

Biceps femoris

Gastrocnemius muscle

More detail in tissue

Patellar tendon

Hoffa's pad

MRI – Proton Density Fat-Suppressed

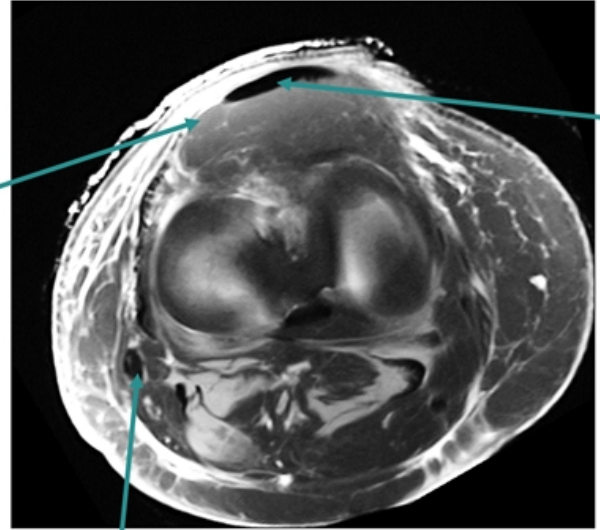

Lack of signal

Biceps femoris – lack of signal on MRI

# Quantitative Segmentation for Speed of Sound

QT Imaging has validated orthopedic imaging using cadavers

## QT SPEED OF SOUND VALUES

- Articular cartilage: 1664 (26.5) m/s
- Medial collateral ligament: ~ 1690 (38) m/s
- Muscle (sartorius): 1571 (28) m/s
- Fat: 1437 (18.5) m/s

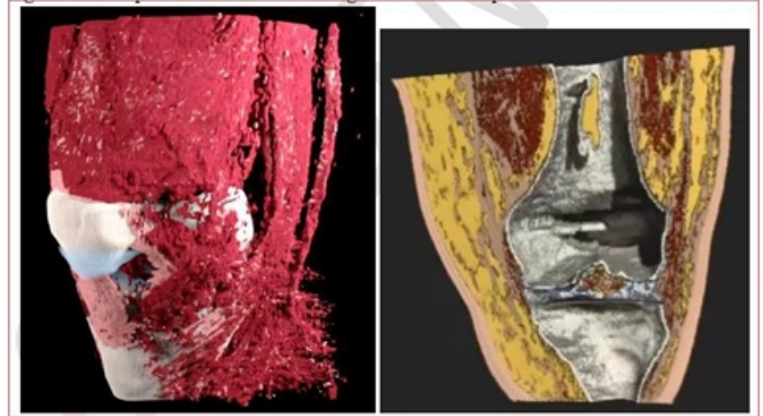

## Point-of-Care Target Markets

- Orthopedic Surgeons (In-Office)
- Sports Teams (On-the Field)
- Military (Ships and Field Use)

# Infant Body Scanner

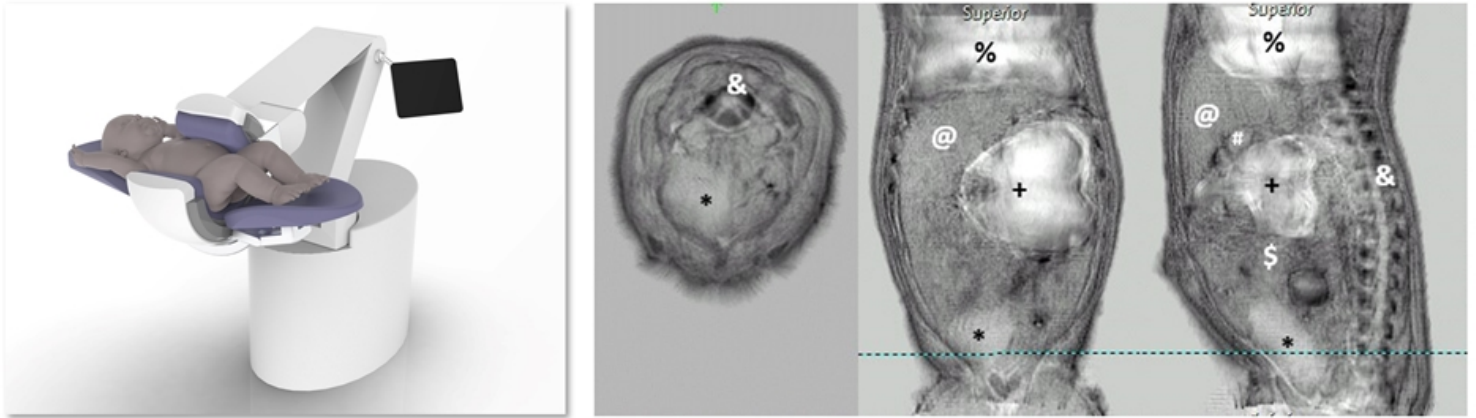

There is a significant opportunity for a safe, inexpensive whole body infant scanner

## WHOLE BODY PIGLET CROSS SECTION

QT Imaging

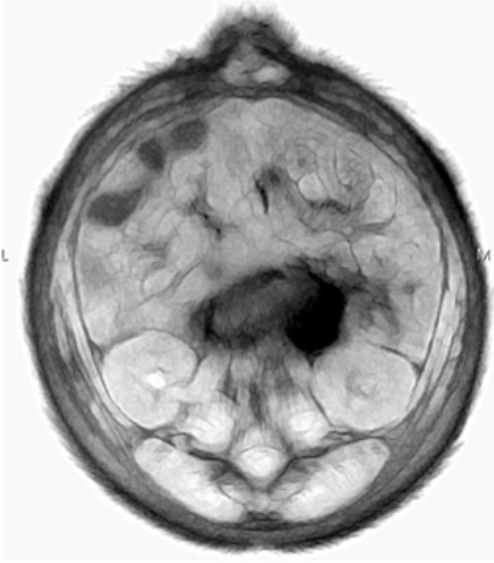

MRI (T2 Fat-suppressed sequence)

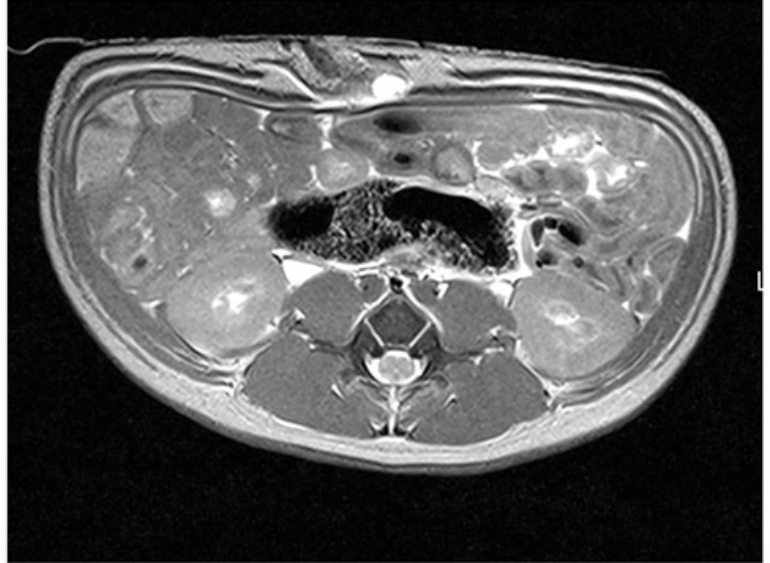



# QT vs 3T MRI

QT Imaging

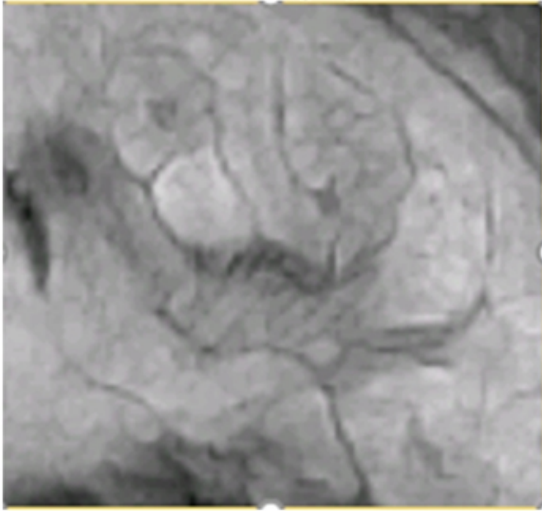

3T MRI

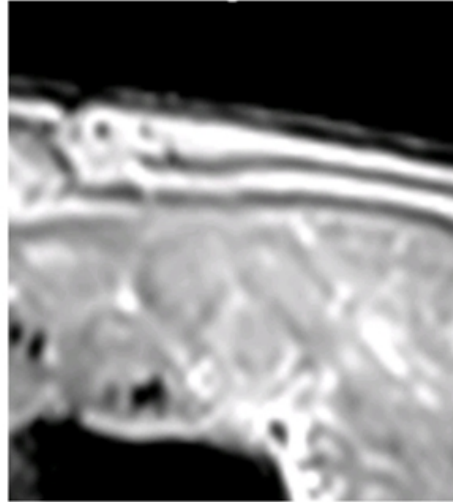

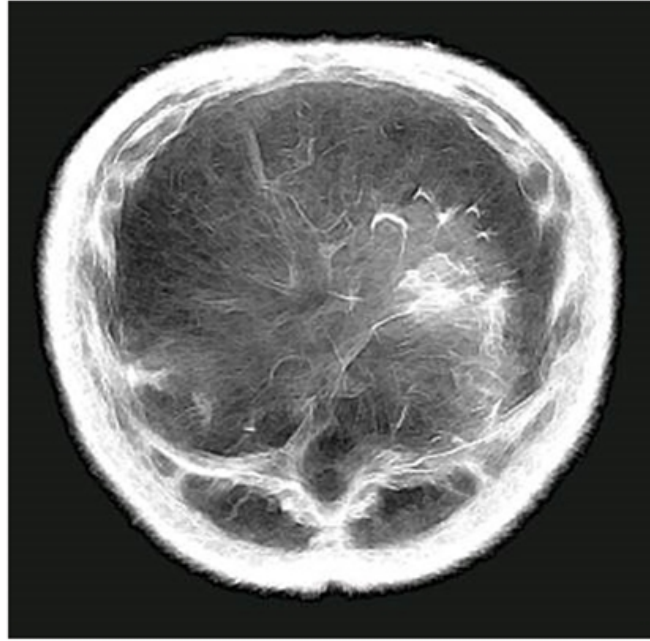

# Eye Imaging Validation

CT

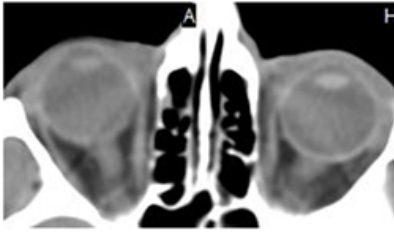

QT

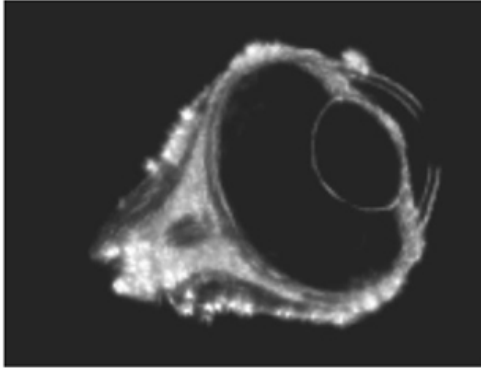

MRI

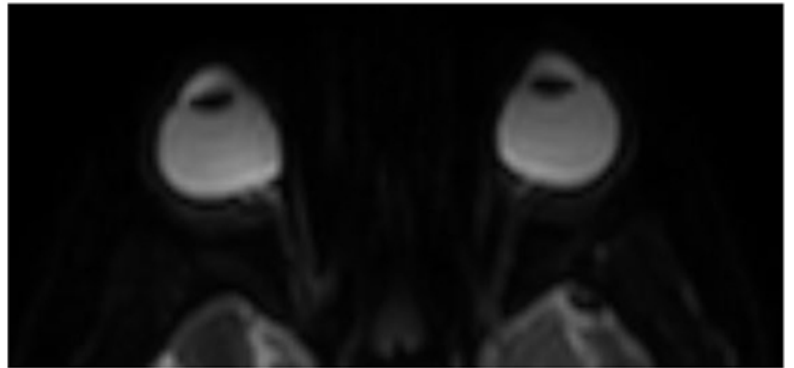

SPEED OF SOUND IMAGING

QT Imaging

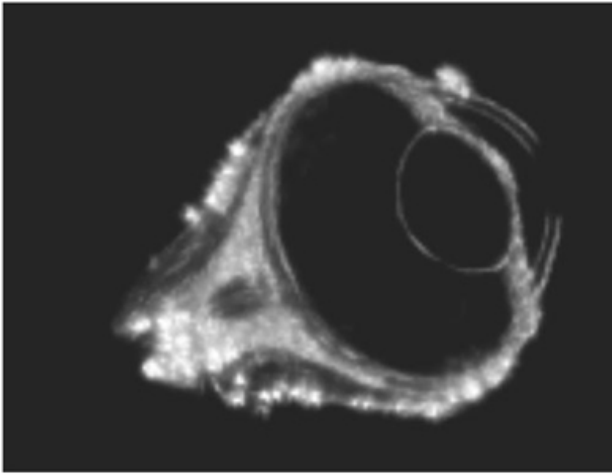

Histology

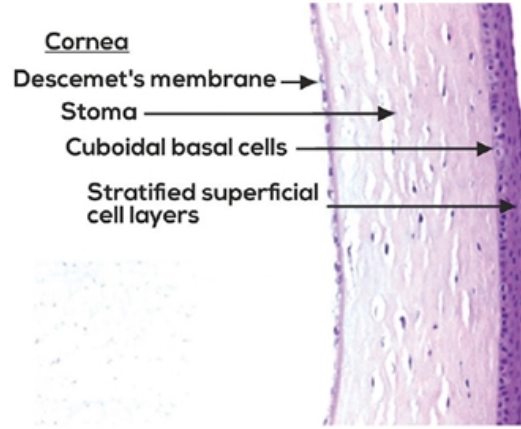

# Open Angle Scanner Development Timeline

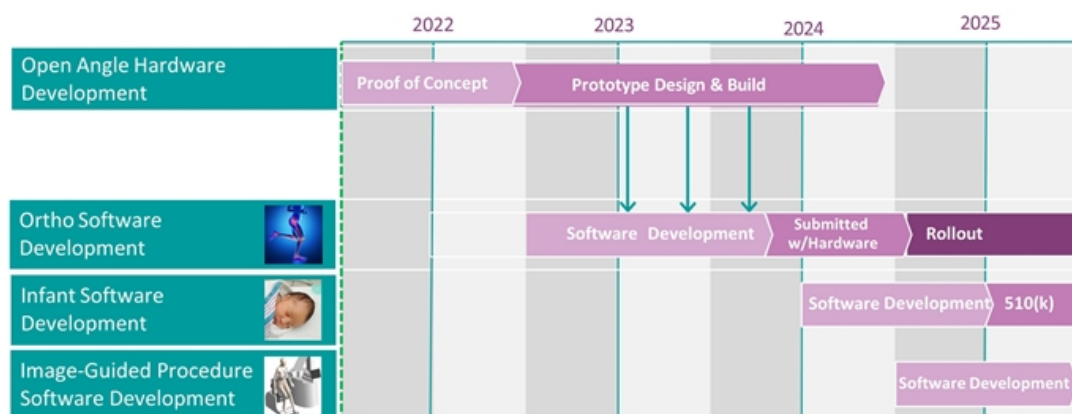

# CLINICAL ADOPTION

QT imaging™

# QT Imaging Platform Has Broad Application Across Breast Health

## SUPPLEMENTAL SCREENING

- Adjunct to mammography
  - Dense Breasts
  - Intermediate to high-risk women
  - Implants
- Primary Screening for mammogram ineligible patients (age <35)
  - Young, high-risk women
  - Women with previous breast or chest radiation
- Adjunctive and/or alternative to handheld ultrasound
- Alternative to breast MRI with gadolinium injection



## DIAGNOSIS

- Quantification of fibroglandular volume
- AI-enabled diagnostics
- Benign vs malignant
- Accurate tumor size
- Potential for biopsy procedures with the 2<sup>nd</sup> generation open angle scanner (currently under development)



## MONITORING

- Ability to use repeatedly with no side effects/non-invasive
- Measure and track mass size and growth
- Assess response to treatments

# Pricing Structures Allow Providers Flexibility in Using the QT Scanner

## INITIAL TARGET MARKETS

Academic Medical  
Centers

Community Cancer  
Centers

Private Practices

Independent Breast  
Imaging Centers

## PRICING MODEL\*

1. Traditional Upfront Purchase:
2. MSaaS (Medical Scan as a Service)/Per Click Model:
3. Turnkey Model (includes scan interpretation):

\* all require annual maintenance and custom disposables



# Reimbursement Will Be Driven by the Value and Savings Provided to Patients

## CURRENT

- Existing CPT codes, non-specific to QT technology:
  - Unilateral or Bilateral breast ultrasound (76641 or 76642)
  - 3D rendering (76377)
  - Other ultrasound procedures (76999)



## FUTURE

- CPT code specific to QTscan®
  - Higher reimbursements capture full value of unique advantages that QT scans offer
  - Process to QT-specific code facilitated by breakthrough designation
- Reimbursement agreements with specific insurance companies and programs
  - Integrated health systems focused on minimizing overall cost of care
  - Programs serving higher risk groups

# OPERATIONS AND FINANCIALS

QT imaging

# QT Imaging Has Full Range of Operational Capabilities

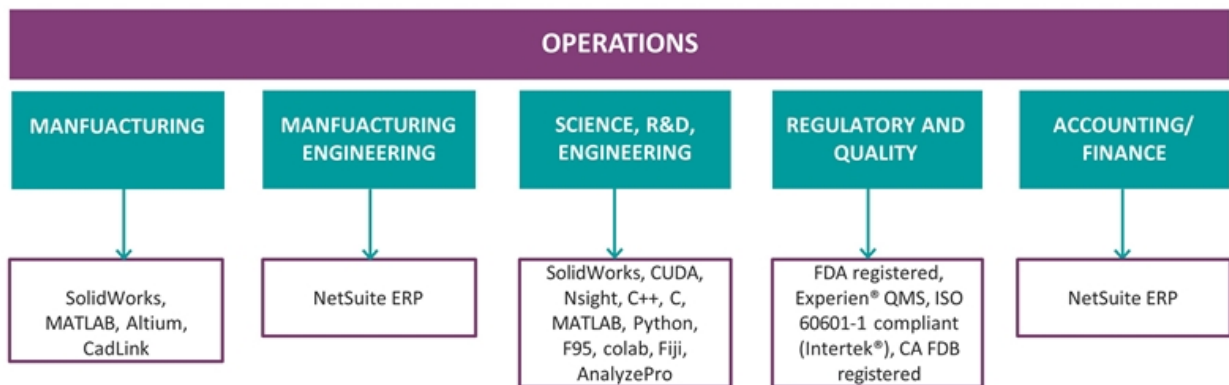

# Hardware Assembly and Software Development Are Internally Managed

## QT ASSEMBLY AND BUILD PROCESS

### Hardware

- Testing and inspection of all incoming components and sub assemblies
  - Data Acquisition Subsystem (QT proprietary design)
  - Transducers (QT proprietary design)
  - Beam Formers (QT proprietary design)
  - GPU (Based on Nvidia)
- Assembly of ~900 parts (excluding common hardware)
- Final calibration, verification/validation, and shipment
- Build/Test time → 270 hours

### Software

- In-house development and installation of software
  - Control – runs the mechanics and user interface
  - Reconstruction – converts raw data into DICOM images
- Interfaces with standard PACS
- Development and production is conducted under design control and QT's QMS system

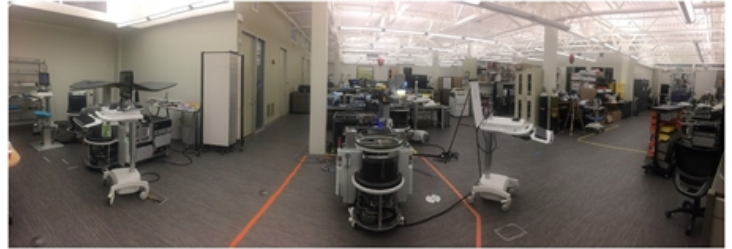

## Scanner Deployment and Availability

- Seven machines deployed
- Seven machines near completion
- Parts for five additional machines currently in inventory
- Eight machines in the pipeline for sale in 2023
- Pipeline of finished goods, WIP, and raw material inventory will enable us to fulfill demands from Asia, EMEA, and the United States and ramp up production as required

# Capital Is Required to Gain Additional FDA Clearances for Breast and Build Out Next Generation Scanner

	Public Company Expense	BREAST SCANNER	NEXT GENERATION OPEN ANGLE SCANNER
	18 Months	18 Months	18 Months
Key Steps	<ul style="list-style-type: none"> <li>D&amp;O</li> <li>Audit</li> <li>Legal</li> <li>Investor Relations</li> </ul>	<ul style="list-style-type: none"> <li>Five NA placements; seven international placements in 2023                             <ul style="list-style-type: none"> <li>Generate clinical data</li> <li>Publish data</li> <li>Develop market advocates</li> </ul> </li> <li>Screening Clearance for high-risk young women</li> <li>Product enhancements</li> <li>Build sales and marketing team</li> </ul>	<ul style="list-style-type: none"> <li>Refine user requirements and value proposition</li> <li>Develop proof of concept and prototype</li> <li>Develop relationships with KOLs and pilot sites</li> </ul>
Major Milestone		FDA Clearance for Screening	Prototype Design
Capital Required	\$4.5M	\$6M	\$5M

# Transaction Detail <sup>(1)</sup>

## TRANSACTION HIGHLIGHTS

- Enterprise Value Post Combination of approx. \$219M
- QT Imaging shareholders to roll 100% of their equity; Equity Value Pre-Combination of approx. \$147M<sup>(3)</sup>
- Seeking to raise \$26M PIPE
- Transaction expected to be completed in H1 2023, QT Imaging to trade on NYSE under ticker "QTI"

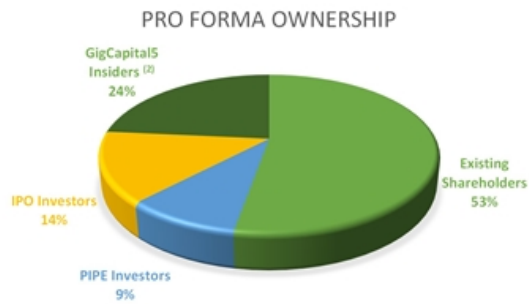

(1) Dollar figures and percentages rounded for presentation.

(2) GigCapital5 Insiders includes Founder Shares and Private Placement Units issued to sponsor and underwriter.

(3) This is calculated as \$151M less approx. \$4M of debt that remains with the company following the business combination.

(4) Share price to be adjusted to the GIA share price in the day of closing.

63

Copyright © 2022 QT Imaging, Inc. All Rights Reserved.

## PRO FORMA VALUATION

\$ IN MILLIONS

Share Price <sup>(4)</sup>	\$10.00
Shares Outstanding (M)	27.9
Equity Value Pre-Combination	\$147
Enterprise Value Post-Combination	\$219

## ILLUSTRATIVE SOURCES & USES

\$ IN MILLIONS

Sources	\$	%
Seller Equity Roll-Over	\$147	67%
Cash in Trust	41	19%
PIPE	26	12%
Debt	4	2%
<b>Total Sources</b>	<b>\$218</b>	<b>100.0%</b>
Uses	\$	%
Seller Equity Roll-Over	\$147	67%
Cash to Balance Sheet	56	26%
Debt	4	2%
Estimated Fees & Expenses	11	5%
<b>Total Uses</b>	<b>\$218</b>	<b>100.0%</b>

QT imaging

# Risk Factors

All references to “QT Imaging,” “Company,” “we,” “us” or “our” refer to the business of QT Imaging, Inc. The risks presented below are certain of the general risks of the Company, GigCapital5, Inc (“SPAC”), and the proposed transaction between the Company and the SPAC (the “Proposed Business Combination”). You should carefully consider these risks and uncertainties, together with the information in this Presentation and the Company’s financial statements and related notes when filed with the U.S. Securities and Exchange Commission, and you should carry out your own diligence and consult with your own financial and legal advisors concerning the risks before making any investment decisions.

## Legal, Regulatory and Compliance Risks

- QT Imaging’s medical device scanners, as well as our business operations and activities, are subject to extensive regulation and compliance obligations, as well as rigorous enforcement, including by the U.S. FDA and numerous other federal, state, and non-U.S. governmental authorities.
- We cannot guarantee that we will be able to obtain or maintain marketing clearance for our new products or enhancements or modifications to existing products.
- The failure to maintain approvals or obtain approval or clearance could have a material adverse effect on our business.
- The use, misuse or off-label use of our products may result in injuries that lead to product liability suits, which could be costly to our business.
- Healthcare reform measures could hinder or prevent the commercial success of our business.
- If clinical studies for future indications do not produce results necessary to support regulatory clearance or approval in the U.S. or elsewhere, we will be unable to commercialize our products for these indications.
- Failure to obtain regulatory approvals in foreign jurisdictions will prevent us from marketing our products internationally.
- Unauthorized third parties may seek to access our devices or our products and services, or related devices, products and services and modify or use them in a way inconsistent with our FDA clearances and approvals, which may create risks to users.
- Our products may be subject to recalls after receiving FDA or foreign approval or clearance which could divert managerial and financial resources, harm or reputation and adversely affect our business.
- If we fail to comply with U.S. federal and state fraud and abuse and other healthcare laws and regulations, including those relating to kickbacks and false claims, we could face substantial penalties and our business operations and financial condition could be harmed.



# Risk Factors – Cont.

## Development Stage Technology Risks

- The market for the Company's medical scanner is subject to technological change.
- The success of the Company depends on the timely perception of new trends, developments and customer needs, constant further development of engineering expertise and ensuring that products and services keep pace with technological developments.
- Our competitors may launch new products and services earlier or at more competitive prices or secure exclusive rights to new technologies.
- If our competitors gain advantages in alternative technologies, this could affect the competitive position of the Company. If these circumstances materialize, it may have a significant adverse effect on the company's business, prospects, financial results, or results of operations.
- Defects or failures associated with our products could lead to recalls, safety alerts or litigation, as well as significant costs and negative publicity.
- Adoption of our product depends upon appropriate healthcare provider training. Inadequate training may lead to negative patient outcomes, effect adoption of our products and adversely affect our business.

## Risks Related to Our Business

- We have a history of generating net losses, and if we are unable to achieve adequate revenue growth while our expenses increase, we may not achieve or maintain profitability in the future.
- If we fail to manage our growth effectively or to sustain our revenue growth, we may be unable to execute our business plan, maintain customer satisfaction or adequately address competitive challenges.
- Members of the Company's management have limited experience in operating a public company. The requirements of being a public company management's attention, and the increases in legal, accounting and compliance expenses that will result from being a public company may be great.
- If we do not attract new customers and increase our customers' use of our products and services, our business will suffer.
- Our ability to recruit, retain, and develop qualified personnel is critical to our success and growth.
- If our technical and maintenance support services are not satisfactory to our customers, they may not buy future products, which could materially affect results of operations and financial condition.
- Any future litigation against us could be costly and time-consuming to defend.
- Our pricing decisions and pricing models may adversely affect our ability to attract new customers and retain existing customers.
- We may require additional capital, which additional financing may result in restrictions on our operations or substantial dilution to our stockholders' business, and this capital might not be available on acceptable terms, if at all.
- The estimates of market opportunity and forecasts of market growth included in this presentation may prove to be inaccurate, and even if the market realizes the forecasted growth, our business could fail to grow at similar rates, if at all.

# Risk Factors – Cont.

## Intellectual Property Risks

- Although the Company has been granted several patents, no assurances can be given that the scope of any patent protection will exclude competitors or provide competitive advantages to the Company, that anticipated and/or desired additional patents will be awarded, that any of the Company's patents will be held valid if challenged or that others will not claim rights in them, or that the Company's existing patents will not be designed around or improved upon by others.
- A loss of any of the Company's key intellectual property rights would be detrimental to the Company's prospects.
- If we fail to adequately protect our intellectual property rights, our competitive position could be impaired, and we may lose valuable assets, generate reduced revenue and become subject to litigation to protect our rights.
- We may be subject to claims by third parties of intellectual property infringement.
- We use open-source software in our devices, which could negatively affect our ability to sell our services or subject us to litigation or other actions.
- Third-party claims that we are infringing intellectual property, whether successful or not, could subject us to costly and time-consuming litigation or expensive licenses, and our business could be adversely affected.
- Our intellectual property applications, including patent applications, may not be approved or granted or may take longer than expected to be approved, which may have a material adverse effect on our ability to prevent others from commercial exploiting products similar to ours.
- In addition to patented technology, we rely on trade secrets, designs, experiences, workflows, data processes, software and know-how.

## Reimbursement of Services

- Most of QT Imaging's customer pool, and the health care providers to whom their customers supply medical services, rely on third-party payers, including government programs and private health insurance plans, to reimburse some or all of the cost of the procedures for which QT Imaging manufactures or produces medical scanners.
- If third-party payer coverage and adequate reimbursement cannot be obtained, sales of the Company's products and the ability to sell our products profitably may decline significantly.
- Changes to reimbursement rates and measures to reduce healthcare costs may adversely impact our business.

## Financing Risk

- The Company will need to raise additional capital to fund its current business plan. It is probable that the Company's plans will change; such changes may require more capital than currently planned. Financing may not be available or may only be available on unfavorable terms.
- If the Company cannot raise adequate funds to satisfy its capital requirements, the Company may need to significantly alter or limit its operations.

### General Business Risks

- Downturns or volatility in general economic conditions could have a material adverse effect on the Company's business, financial condition, results of operations and liquidity.
- The Company's competitive position could be adversely affected if it is unable to meet customers' quality requirements.
- If the Company is unable to expand or further diversify its customer base, its business, financial condition, and results of operations could suffer.
- If the Company's products do not conform to, or are not compatible with, existing or emerging industry standards, demand for its products may decrease, which in turn would harm the Company's business and operating results.
- The Company is subject to risks and uncertainties associated with international operations, which may harm its business.
- The Company's company culture has contributed to its success and if the Company cannot maintain this culture as it grows, its business could be harmed.
- The Company may not be able to effectively manage its growth and may need to incur significant expenditures to address the additional operational and control requirements of its growth, either of which could harm the Company's business and operating results.
- The Company may from time-to-time desire to exit certain programs or businesses, or to restructure its operations, but may not be successful in doing so.
- The Company may pursue mergers, acquisitions, investments and joint ventures, which could divert its management's attention or otherwise disrupt its operations and adversely affect its results of operations.
- The Company may not be able to convert its pipeline or orders in backlog into revenue.
- The Company may not manage its growth effectively.
- Our forecasts and projections are based on assumptions, analyses and internal estimates developed by our management. If these assumptions, analyses or estimates prove to be incorrect or inaccurate, our actual operating results may differ materially from those forecasted or projected.
- The market adoption of our product is evolving and may develop more slowly or differently than we expect. Our future success depends on the growth and expansion of these markets and our ability to adapt and respond effectively to evolving markets.
- Interruption or failure of our information technology and communication systems could impact our ability to effectively provide our products and services.
- We are subject to cybersecurity risks to operational systems, security systems, infrastructure, integrated software in our products and customer data processed by us or third-party vendors or suppliers and any material failure, weakness, interruption, cyber event, incident or breach of security could hinder the effective operation of our business.

### Risks Related to the Business Combination

- The Proposed Business Combination may disrupt current plans and operations of the Company.
- If the Proposed Business Combination's benefits do not meet expectations of investor or securities analysts, the market price of the SPAC's securities, or following the consummation of the Proposed Business Combination, the combined company's securities, may decline.
- The valuation ascribed to the combined company may not be indicative of the price that will prevail in the trading market following the Proposed Business Combination. If an active market for the combined company's securities develops and continues, the trading price of the combined company's securities following the Proposed Business Combination could be volatile and subject to wide fluctuations in response to various factors, which could contribute to the loss of all or part of your investment.
- Both the SPAC and the Company will incur significant transactions costs in connection with the Proposed Business Combination.
- The SPAC and the Company may not successfully or timely consummate the Proposed Business Combination, including the risk that any required regulatory approvals are not obtained, are delayed or are subject to unanticipated conditions that could adversely affect the combined company or the expected benefits of the Proposed Business Combination or that the approval of the stockholders of the SPAC is not obtained.
- The consummation of the Proposed Business Combination is subject to a number of conditions and if those conditions are not satisfied or waived, the Proposed Business Combination agreement may be terminated in accordance with its terms and the Proposed Business Combination may not be completed.
- There is no guarantee that a stockholder's decision whether to redeem its shares for a pro rata portion for the trust account will put the stockholder in a better future economic position.
- Legal proceedings in connection with the Proposed Business Combination, the outcomes of which are uncertain, could delay or prevent the completion of the Proposed Business Combination.
- Following the consummation of the Proposed Business Combination, the combined company will incur significant increased expenses and administrative burdens as a public company, which could have an adverse effect on its business, financial condition and results of operation.
- Changes in laws or regulations, or a failure to comply with any laws and regulations, may adversely affect the Company's or the combined company's business, including the ability of the parties to consummate the Proposed Business Combination, and results of operation of the Company or the combined company.
- The ability to successfully effect the Proposed Business Combination and the combined company's ability to successfully operate the business thereafter will be largely dependent upon the efforts of certain key personnel of the Company, all of whom we expect to stay with the combined company following the Proposed Business Combination. The loss of such key personnel could negatively impact the operation and financial results of the combined business.
- The SPAC's ability to complete an initial business combination may be adversely affected by downturns in the financial markets or in economic conditions, increases in oil prices, inflation, increases in interest rates, supply chain disruptions, declines in consumer confidence and spending, the ongoing effects of the COVID-19 pandemic, including resurgences and the emergence of new variants, geopolitical instability, such as the military conflict in the Ukraine.



Thank You!